



# **Getting Started with TI-Nspire™ Navigator™ Teacher Software**

This guidebook applies to TI-Nspire™ software version 3.2. To obtain the latest version of the documentation, go to [education.ti.com/guides](http://education.ti.com/guides).

## ***Important Information***

Except as otherwise expressly stated in the License that accompanies a program, Texas Instruments makes no warranty, either express or implied, including but not limited to any implied warranties of merchantability and fitness for a particular purpose, regarding any programs or book materials and makes such materials available solely on an "as-is" basis. In no event shall Texas Instruments be liable to anyone for special, collateral, incidental, or consequential damages in connection with or arising out of the purchase or use of these materials, and the sole and exclusive liability of Texas Instruments, regardless of the form of action, shall not exceed the amount set forth in the license for the program. Moreover, Texas Instruments shall not be liable for any claim of any kind whatsoever against the use of these materials by any other party.

### **License**

Please see the complete license installed in

**C:\Program Files\TI Education\<TI-Nspire™ Product Name>\license.**

© 2011 - 2012 Texas Instruments Incorporated

Mac®, Windows®, Excel®, PowerPoint®, Microsoft® Internet Explorer®, Mozilla® FireFox®, Java™, Google® Chrome®, Apple® Safari®, Vernier DataQuest™, and Blackboard™ are trademarks of their respective owners.

# Contents

<b>Setting up the TI-Nspire™ Navigator™ Teacher Software ...</b>	<b>1</b>
Unpacking the Boxes.....	2
Charging the Cradles.....	3
Installing the Handheld Software .....	5
Connecting the Handhelds to the Wireless Adapters .....	7
Connecting the Handhelds to Cradles .....	8
Connecting the Access Point to the Computer.....	9
Setting up a Network the First Time .....	10
Configuring the Access Point.....	12
Adding Wireless Clients to the Network.....	13
Adding Wireless Adapters or Cradles Manually .....	15
Removing Adapters or Cradles from an Existing Network .....	16
Saving a Network .....	17
Reusing a Saved Network .....	17
Checking the Network Status .....	18
Creating and Managing Your Teacher Account .....	21
Logging In to the TI-Nspire™ Navigator™ System from the Handheld.....	23
Storing the Wireless Adapters and Cradles .....	26
<b>Getting Started with TI-Nspire™ Navigator™ Teacher Software .....</b>	<b>27</b>
Exploring the TI-Nspire™ Navigator™ Teacher Software.....	29
Exploring Workspaces .....	31
Exploring the Status Bar .....	31
Changing Language .....	33
<b>Tracking and Reporting System Use .....</b>	<b>35</b>
Creating the SessionLogs Folder.....	35
Managing Session Logs .....	36
Packaging and Sending Session Logs .....	38
<b>Using the Content Workspace .....</b>	<b>41</b>
Exploring the Content Workspace .....	41
Exploring the Resources Pane.....	42
Using the Preview Pane .....	44
Accessing Computer Content .....	45
Using Shortcuts.....	47
Working with Links .....	48
Using Web Content .....	50
Sending Files to Class .....	54

<b>Working with Connected Handhelds .....</b>	<b>57</b>
Viewing Content on Connected Handhelds.....	57
Managing Files on a Connected Handheld .....	59
Sending Files to Handhelds.....	62
Checking for an OS Update.....	64
Installing an OS Update.....	66
Renaming Handhelds .....	68
Using Identify Selected to Locate Handhelds .....	69
<b>Using the Class Workspace .....</b>	<b>71</b>
Adding Classes .....	71
Adding Students to Classes .....	75
Removing Students from Classes .....	77
Updating Class Rosters .....	78
Managing Classes.....	80
Beginning and Ending a Class Session.....	82
Changing the Student View.....	83
Arranging the Seating Chart.....	84
Checking Student Login Status.....	84
Sorting Student Information.....	85
Changing the Classes Assigned to a Student .....	85
Changing Student Names and Identifiers .....	87
Moving Students to Another Class .....	88
Copying Students to Another Class .....	89
Exploring the Class Record .....	89
Sending Files to a Class.....	91
Collecting Files from Students .....	94
Managing Unprompted Actions.....	97
Saving Files to a Portfolio Record .....	98
Deleting Files from Class Folders .....	99
Checking the Status of File Transfers.....	100
Canceling File Transfers .....	100
Viewing File Properties.....	101
Resetting Student Passwords .....	101
<b>Capturing Screens .....</b>	<b>105</b>
Accessing Screen Capture.....	106
Using Capture Class .....	106
Setting Teacher Preferences for Capture Class .....	108
Setting View Options in Capture Class .....	109
Creating Stacks of Student Screens .....	113
Comparing Selected Screens .....	114
Using Make Presenter.....	115
Saving Screens When Using Capture Class.....	115
Printing Captured Screens.....	116

Using Capture Page.....	118
Using Capture Selected Handheld.....	119
Viewing Captured Screens.....	120
Saving Captured Pages and Screens.....	121
Copying and Pasting a Screen.....	122
Capturing Images in Handheld Mode.....	123
<b>Using Live Presenter .....</b>	<b>127</b>
Before Starting Live Presenter.....	127
Starting Live Presenter.....	127
Hiding and Showing Student Names.....	130
Hiding and Showing the Presenter Handheld.....	131
Viewing Keypress History.....	132
Showing the Handheld Screen Only.....	134
Recording the Live Presentation.....	135
Stopping Live Presenter.....	137
<b>Using the Documents Workspace .....</b>	<b>139</b>
Exploring the Documents Workspace.....	139
Using the Documents Toolbox.....	140
Exploring Document Tools.....	140
Exploring the Page Sorter.....	141
Exploring the TI-SmartView™ Feature.....	142
Exploring Content Explorer.....	143
Exploring Utilities.....	145
Using the Work Area.....	147
Changing Document Settings.....	147
Changing Graphs & Geometry Settings.....	149
<b>Using Question in the Teacher Software .....</b>	<b>153</b>
Understanding the Question Tools.....	154
Using the Teacher Tool Palette.....	155
Understanding the Configuration Tool.....	156
Formatting Text and Objects.....	157
Adding Images to Questions.....	157
Adding Questions.....	158
<b>Polling Students.....</b>	<b>175</b>
Opening the Quick Poll Tool.....	176
Sending a Quick Poll.....	178
Stopping Polls.....	178
Resending Polls.....	179
Sending Polls to Missing Students.....	179
Saving Polls.....	180

Viewing Poll Results.....	180
<b>Working with TI-Nspire™ Documents .....</b>	<b>183</b>
About Documents.....	183
Creating a New TI-Nspire™ Document .....	183
Opening an Existing Document .....	184
Saving TI-Nspire™ Documents .....	185
Deleting Documents.....	186
Closing Documents .....	186
Formatting Text in Documents .....	187
Using Colors in Documents .....	188
Working with Multiple Documents .....	189
Working with Applications .....	190
Selecting and Moving Pages .....	193
Working with Problems and Pages.....	195
Printing Documents.....	197
Viewing Document Properties and Copyright Information .....	198
<b>Working with PublishView™ Documents .....</b>	<b>203</b>
Creating a New PublishView™ Document.....	204
Saving PublishView™ Documents .....	209
Exploring the Documents Workspace .....	210
Working with PublishView™ Objects.....	214
Working with TI-Nspire™ Applications.....	220
Working with Problems.....	224
Organizing PublishView™ Sheets.....	226
Using Zoom .....	231
Adding Text to a PublishView™ Document.....	232
Using Hyperlinks in PublishView™ Documents .....	234
Working with Images .....	240
Working with Video Files .....	242
Converting Documents.....	244
Printing PublishView™ Documents.....	247
<b>Using the Review Workspace.....</b>	<b>249</b>
Using the Review Toolbox.....	249
Exploring the Data View Pane .....	255
Opening Documents for Review.....	258
Viewing Data .....	260
Changing the Aspect Ratio .....	262
Organizing Responses .....	262
Hiding and Showing Responses.....	267
Marking Responses as Correct or Incorrect.....	270
Adding Teacher Data.....	275
Saving to the Portfolio Workspace.....	278

Saving Data as a New Document .....	279
<b>Using the Portfolio Workspace .....</b>	<b>281</b>
Exploring the Assignments Pane .....	281
Exploring the Workspace Views .....	282
Saving an Item to the Portfolio Workspace .....	285
Importing an Item to the Portfolio Workspace .....	286
Editing Scores .....	287
Exporting Results .....	289
Sorting Information in the Portfolio Workspace .....	291
Opening a Portfolio Item in Another Workspace .....	291
Opening a Master Document .....	292
Adding a Master Document .....	293
Redistributing a Portfolio Item .....	293
Collecting Missing Files from Students .....	294
Sending Missing Files to Students .....	294
Renaming a Portfolio Item .....	294
Removing Columns from Portfolio .....	295
Removing Individual Files from Portfolio .....	295
<b>Working with Images .....</b>	<b>297</b>
Working with Images in the Software .....	297
<b>Using the Script Editor .....</b>	<b>301</b>
Overview of the Script Editor .....	301
Exploring the Script Editor Interface .....	302
Using the Toolbar .....	303
Inserting New Scripts .....	304
Editing Scripts .....	305
Saving Script Applications .....	306
Inserting Images .....	306
Changing View Options .....	307
Setting Script Permissions .....	307
Debugging Scripts .....	308
<b>Regulatory Information .....</b>	<b>309</b>
Warning Statements .....	309
Texas Instruments Support and Service .....	311
Service and Warranty Information .....	311
<b>Index .....</b>	<b>313</b>





# Setting up the TI-Nspire™ Navigator™ Teacher Software

The TI-Nspire™ Navigator™ classroom learning system provides the hardware and software tools you need to set up a wireless classroom network.

The hardware creates a wireless communications network so that your computer can communicate with student handhelds. The hardware includes TI-Nspire™ CX Wireless Network Adapters, TI-Nspire™ Navigator™ Cradles, and the TI-Nspire™ Navigator™ Access Point.

The wireless adapters are used to communicate between the TI-Nspire™ CX or TI-Nspire™ CX-C handhelds and the access point. The cradles are used to communicate between any of the TI-Nspire™ handhelds and the access point.

The TI-Nspire™ Navigator™ Access Point is the communication link used in all wireless classroom setups. The TINAVAP2 access point supports the following wireless clients:

- TI-Nspire™ CX Wireless Network Adapters
- TI-Nspire™ Navigator™ Cradles with FCC or IC numbers ending in TINAVWC2

The software contains a number of tools to enhance your classroom, including:

- **Quick Poll.** Lets you send polls to students, receive student responses to the polls, and review the poll results with your students.
- **Screen Capture.** Lets you capture screens from the students' handhelds or computers automatically or at specific time intervals. You can collect a stack, or history, of screens.
- **Live Presenter.** Lets you display work as it is being performed on your handheld screen or on student handheld screens.
- **Review.** Lets you collect and review student assignments, watch results in real time as students answer questions, and analyze data for the entire class or for individual students.

You can obtain educational content at TI's Activities Exchange: [education.ti.com/activities](http://education.ti.com/activities).

## Unpacking the Boxes

The TI-Nspire™ Navigator™ System product consists of TI-Nspire™ Navigator™ Teacher Software, an access point, and either 15 or 30 cradles or wireless adapters, depending on your specific order. If necessary, you can purchase additional kits to accommodate as many as 60 students.

Identify each item, and check the items against the following lists to make sure your order is complete.

Each TI-Nspire™ Navigator™ System comes with the following items.

- One TI-Nspire™ Navigator™ Access Point
- Two USB computer cables: One 18 inch and one 60 inch
- One DVD containing TI-Nspire™ Navigator™ Teacher Software
- The *Getting Started with the TI-Nspire™ Navigator™ Teacher Software* guide



One access point

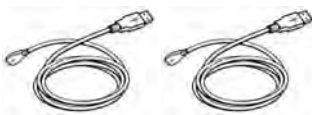

Two USB cables



One DVD



Getting Started Guide

If you purchased the TI-Nspire™ Navigator™ System for use with the TI-Nspire™ CX, TI-Nspire™ CX CAS, TI-Nspire™, or TI-Nspire™ CAS handhelds, contents include the following items:

- TI-Nspire™ Navigator™ Cradles
- AC9940 power adapter (includes power supply and power cord)
- TI-Nspire™ Navigator™ Cradle Charging Bay

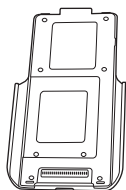

Cradles



AC9940 power adapter (for the charging bay)

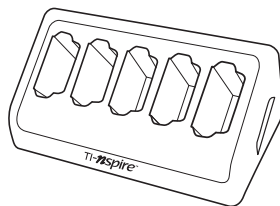

Cradle charging bay

If you purchased the TI-Nspire™ CX Navigator™ System for use with the TI-Nspire™ CX or TI-Nspire™ CX CAS handhelds exclusively, contents include the following items. Quantities will vary, depending on the system you purchased.

- TI-Nspire™ CX Wireless Network Adapters
- TI-Nspire™ CX Wireless Network Adapter storage cases

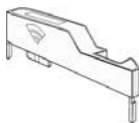

Wireless network adapter



Storage case for the TI-Nspire™ CX Wireless Network Adapters

## ***Charging the Cradles***

The TI-Nspire™ Navigator™ Cradles contain rechargeable batteries. You must charge the batteries overnight before using them in class. When the cradles are fully charged, they will function all day under continuous use. You should recharge them each night.

The TI-Nspire™ Navigator™ Cradle Charging Bay can hold from one to five cradles. After you place the cradles in the charging bay, they are charged simultaneously until all are fully charged. If the batteries are fully discharged, it may take up to 12 hours to fully charge the batteries.

**Note:** You cannot damage the batteries by leaving them in the charging bay beyond the time needed to fully charge them. Also, it is not necessary to fully discharge the batteries before recharging them.

Make sure you have enough (3 to 4) power outlets for the equipment you received. If necessary, obtain a power strip so that you have plenty of grounded outlets.

1. Insert the small end of the AC9940 power adapter cord into the charging bay's power jack.

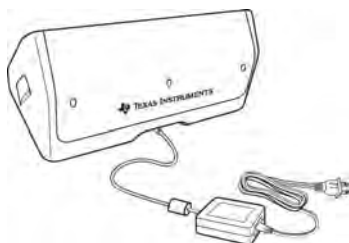

2. Plug the other end of the adapter into a power outlet.
3. Insert each TI-Nspire™ Navigator™ Cradle into the TI-Nspire™ Navigator™ Cradle Charging Bay. Make sure the LED is amber.



**Note:** You can charge a single wireless cradle using an AC9926 adapter (sold separately).

### Checking the LEDs

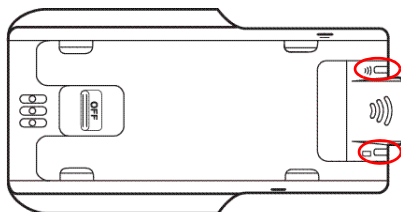

Two LEDs (small lights) at the top of each TI-Nspire™ Navigator™ wireless cradle blink or change colors to indicate various operations or status.



LEDs

The  LED indicates network activity. The  LED indicates battery-charging status.

When the cradles are still in the TI-Nspire™ Navigator™ Cradle Charging Bay:

- A solid amber  LED means the wireless cradle is currently recharging.
- A solid red  LED means the wireless cradle does not have good contact with the charging bay. Reposition the cradle to establish good contact and the LED turns amber.
- A solid green  LED means the wireless cradle is fully charged.

## ***Installing the Handheld Software***

Before you use the TI-Nspire™ Navigator™ Teacher Software with handhelds, make sure you have the latest operating system installed on all of the handhelds for the software to work properly.

You can use the TI-Nspire™ Navigator™ Teacher Software to update the handheld operating system.

**Note:** After you install the latest OS on one handheld, you can use that handheld to install the OS on other handhelds.

1. Connect a TI-Nspire™ handheld to your computer.
2. Show all connected handhelds.
  - In the Content Workspace, click **Connected Handhelds** in the Resources pane.
  - In the Documents Workspace, open the Content Explorer and click **Connected Handhelds**.
3. Click the handheld you want to update.
4. Click **Help > Check for Handheld/Lab Cradle OS Update**.

The Check for Handheld/Lab Cradle OS Update dialog box opens.

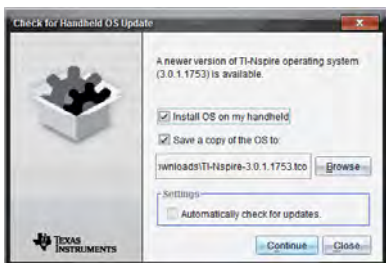

5. Click **Install OS on my handheld**.

You can also save a copy of the OS file on your computer by clicking the **Save a copy of the OS to** check box. Click **Browse** to navigate to the location where you want to save the handheld OS if different from the default location.

6. Click **Continue**.

7. Accept the license agreement and click **Continue**.

TI-Nspire™ Navigator™ Teacher Software displays a message box warning you that any unsaved data will be lost. Click **Yes** to continue.

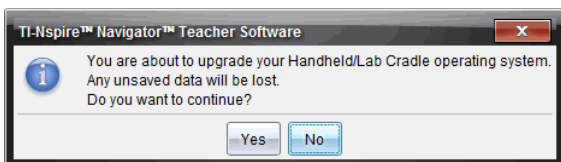

The Installing OS dialog box opens, showing the status of the installation.

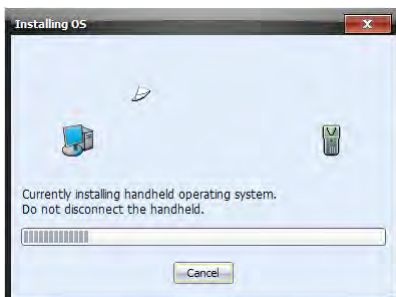

8. When the operating system software has transferred to your TI-Nspire™ handheld, click **OK**. You may now disconnect the handheld from the computer, and the operating system software will install itself onto the handheld.

## Connecting the Handhelds to the Wireless Adapters

The TI-Nspire™ CX wireless network adapters work with the TI-Nspire™ CX and TI-Nspire™ CX CAS handhelds. To connect the handheld to the wireless adapter, follow these steps.

1. Position the wireless adapter on top of the handheld so the connector on the adapter lines up with the connector on top of the handheld.

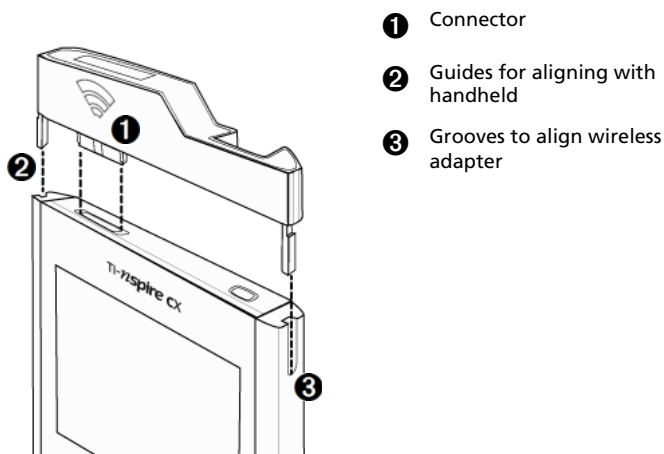

2. Slide the adapter into position, making sure the guides on the sides of the adapter slide into the grooves on the sides of the handheld.
3. Firmly press the adapter into place.

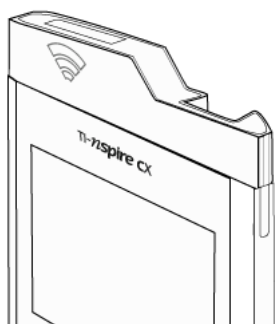

## Connecting the Handhelds to Cradles

The cradles work with the TI-Nspire™, TI-Nspire™ CAS, TI-Nspire™ CX and TI-Nspire™ CX CAS handhelds. To connect the handheld to a cradle, follow these steps.

1. Slide the lock on the back of the cradle to the OFF position.

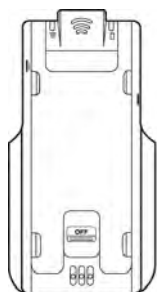

Lock in OFF position.

2. To attach the handheld, face the screen upward and slide the handheld onto the top of the TI-Nspire™ Navigator™ wireless cradle. Be sure that both sides of the handheld are inserted into both of the side guides.

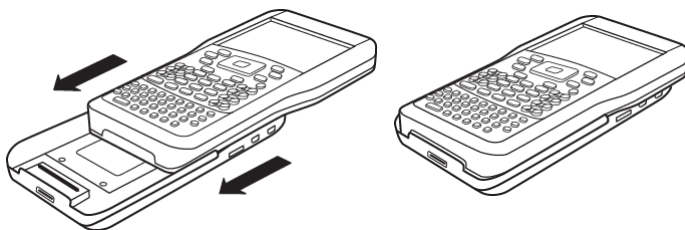

3. Press firmly to make a good connection. When properly connected, the TI-Nspire™ handheld appears to be sitting on top of the cradle.



4. Lock the handheld in place by sliding the lock on the back of the cradle to the ON position.

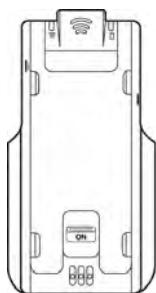

Lock in ON position.

5. Insert each cradle into the charging bay. Make sure the LED is amber.

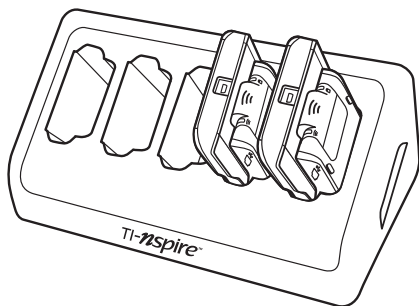

At the end of the school day, return the wireless cradle to the charging bay and charge them overnight. The cradles are charged when all the □ (power status) LEDs are solid green or amber.

## **Connecting the Access Point to the Computer**

The TI-Nspire™ Navigator™ Access Point is powered by your computer. When you connect the access point to your computer, it is powered on and ready to communicate with wireless network adapters and cradles.

1. Connect the small end of the USB cable to the access point.

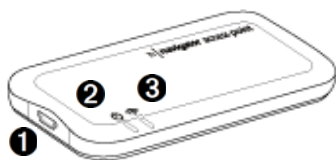

- ❶ USB connection
- ❷ Power light
- ❸ Signal light

2. Connect the other end of the cable to the USB port on your computer.
3. Make sure the access point power light is on.

The power light indicates that the access point is receiving power from the computer. The signal light indicates wireless link activity.

The software may display a message saying the access point firmware needs to be updated.

**Note:** You must update the firmware for the networked classroom system to work properly.

- ▶ Click **Yes** to update the access point firmware.

TI-Nspire™ Network Manager sends signals to the access point to add it to the network.

After the access point is found, the wizard displays a message.

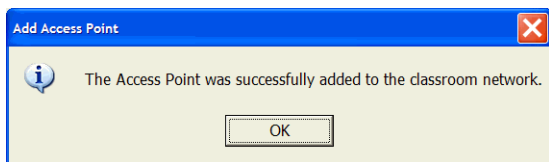

4. Click **OK**.

## ***Setting up a Network the First Time***

The first time you use the software, a Network Setup wizard helps you associate the access point and wireless adapters and cradles for wireless communication. You only have to set up a network one time. After you set up a network the first time, you can simply open the software and start a class.

Before you begin, make sure the following steps have been completed.

- You have installed and activated the TI-Nspire™ Navigator™ Teacher Software on your computer.

- If you are using TI-Nspire™ Navigator™ Cradles, make sure each cradle is charged (LED is solid amber or solid green).

**Note:** If you are using TI-Nspire™ Wireless Network Adapters, you do not need to charge them. The wireless network adapters are powered by the TI-Nspire™ CX or TI-Nspire™ CX CAS handheld.

- All handhelds are fully charged, and have the latest operating system installed.
- A cradle or network adapter is attached to each handheld.

The setup wizard helps you through the next steps.

**Note:** You can run the setup wizard later by opening Network Manager and clicking **Actions > Network Setup Wizard**.

1. Make sure the access point is connected to the computer with the USB cable.
2. Click **Setup Now** to proceed with the wizard.

The Identify Handheld OS Version dialog box opens.

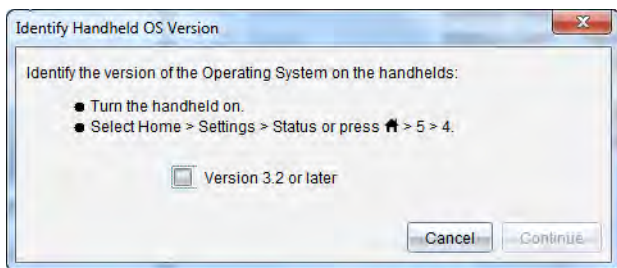

3. Select the checkbox if handhelds have OS Version 3.2 or later, and then click **Continue**.

Click **Cancel** if the OS version on any handheld needs to be updated. Update the OS on all handhelds, and then start the wizard again.

**Note:** See the previous section *Installing the Handheld Software* for information on installing the latest OS on all of the handhelds.

The Navigator Network Name dialog box opens.

4. Type a network name and click **Next**.

**Notes:**

- Students will see all available network names when they log in to class, so name the network something unique that describes the location of your class. For example: **Room 215**.

- The network name can be from 1 to 22 characters long, and can include letters, spaces, characters, and numbers. Some special characters that cannot be used are ? " % \ +.

The next step is to configure the access point.

## **Configuring the Access Point**

After you name a network, the setup wizard opens the Select Channel dialog box.

The operating channel is automatically set to a default setting. You can change it later if necessary. The available channels are 1 through 11.

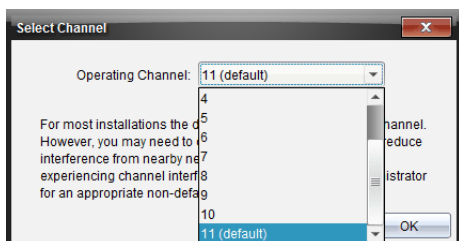
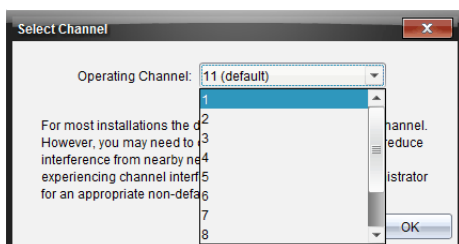

Click **OK**.

The wizard opens the Adding Wireless Clients dialog box.

## **Adding Wireless Clients to the Network**

The next step in setting up a network is to associate the TI-Nspire™ CX Wireless Network Adapters and TI-Nspire™ Navigator™ Cradles with your classroom network. Associating wireless clients requires you to perform tasks on the TI-Nspire™ software and on TI-Nspire™ handhelds. As you add wireless clients, the Adding Wireless Clients dialog box in the Network Manager updates to show the additions.

**Note:** Before you add wireless clients to the network, make sure the TI-Nspire™ Navigator™ Cradles are charged.

1. Turn on each TI-Nspire™ handheld.
2. Attach the wireless adapter or the wireless cradle to each handheld.  
(See the instructions for connecting wireless adapters or cradles to a TI-Nspire™ handheld.)
3. From the Home screen of the TI-Nspire™ handheld, select **5:Settings > 6:Network**.

The handheld lists the available networks that are within range.



4. Select the network you just created and click **Connect**.

In the Network Manager, the Adding Wireless Clients dialog box opens, listing all adapters and cradles that were found.

**Note:** To open the TI-Nspire™ Network Manger, click **Tools > Network Manager**.

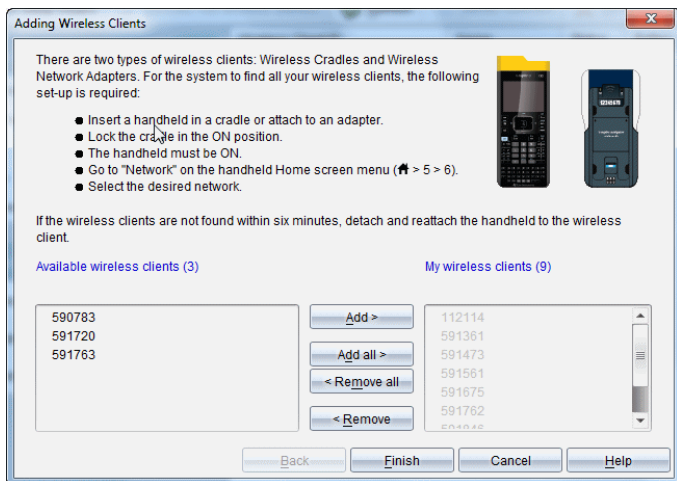

5. Highlight each wireless adapter or wireless cradle you want to add, and then click **Add**.

To add all of the wireless clients listed in the Available Wireless Clients column, click **Add All**.

**Note:** If the adapter or cradle does not appear in the Available Wireless Clients column after six minutes, try these tips:

- Check the ID numbers of the wireless adapters or cradles to see which ones are not connecting.
- Detach and reattach the wireless adapter or wireless cradle to the handheld.
- Verify that the cradle is locked. (The lock on the back of the cradle is in the ON position.)

6. When all of the adapters and cradles are added, click **Finish**.

The software asks if you want to save the network. It is a good idea to save the network information; the network can be reused on a different computer with a new installation of the software. If you decide not to save the network now, you can always save it later using the **Actions** menu.

7. To save the network, click **Yes**.

The Save dialog box opens. By default, the TI-Nspire™ Navigator software creates a file named **Navigator Network mm\_dd\_yyyy** in the Documents > TI-Nspire>Navigator Network path.

8. Click **Save**, or choose another folder or file name, and then click **Save**.

To view the status of the connected handhelds, click **Actions > Refresh**.

## ***Adding Wireless Adapters or Cradles Manually***

The Network Setup wizard automatically guides you through the process for adding wireless adapters or cradles. In addition, you can manually add wireless adapters or cradles at any time by following the procedures below.

When you add a wireless adapter or cradle manually, it immediately appears in the TI-Nspire™ Network Manager window.

1. Click **Tools > Network Manager**.

The Network Manager window opens.

2. Click **Manually Add Wireless Client(s)**.

The Add Wireless Clients by ID Number dialog box opens.

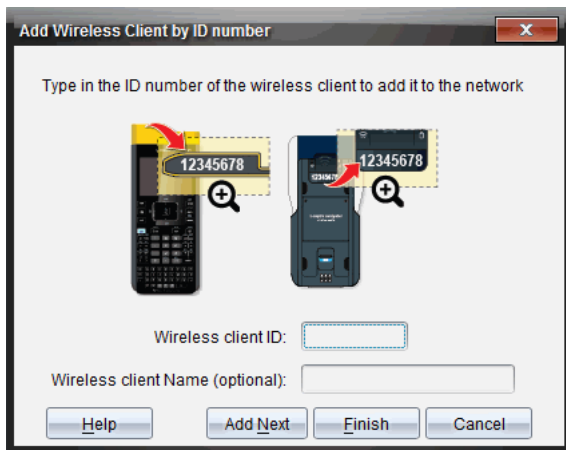

3. For each wireless adapter or cradle you are adding, find the ID number on the back of the adapter or cradle, and type it in the **Wireless Client ID** box. The ID is the last six digits of the eight-digit number (ignore the first two zeros).
4. Enter a nickname in the **Wireless Client Nickname** box (optional).  
Nicknames can consist of letters, spaces, and numbers. A nickname must contain a minimum of 1 character and can contain a maximum of 64 characters.
5. Click **Add Next** to add another adapter or cradle if you have more than one wireless client to add.
6. When you are finished adding all the adapters and cradles, click **Finish**.

After you manually add wireless clients, you need to associate them to the network using the handhelds.

7. Turn on each TI-Nspire™ handheld.
8. Attach the wireless adapter or the wireless cradle to each handheld. (See the instructions for connecting wireless adapters or cradles to a TI-Nspire™ handheld.)
9. From the Home screen of the TI-Nspire™ handheld, select **5:Settings > 6:Network**.

The handheld lists the available networks that are within range.



10. Select the network you added the wireless clients to, and click **Connect**.

The wireless clients are now associated with the access point.

## ***Removing Adapters or Cradles from an Existing Network***

Even though a classroom network has been set up correctly, sometimes you may need to remove TI-Nspire™ Navigator™ Wireless Network Adapters or TI-Nspire™ Navigator™ Cradles from the network.

You might need to remove adapters or cradles because your access point has been associated with wireless clients that should belong to another classroom.

1. In the TI-Nspire™ Network Manager window, select the wireless adapters and cradles that you want to remove from the network.
2. Click **Actions > Remove Selected** or click .
3. Click **Remove** at the prompt.

The wireless client is no longer listed in the Network Manager window.

## ***Saving a Network***

After you have set up your network, you can save the setting so it can be used at a later time if necessary.

The saved network information includes the list of wireless clients, the network name, and the channel selected on the access point.

1. Click **Tools > Network Manager**.  
The Network Manager window opens.
2. Click **Actions > Save Network Setup**.



The save dialog box opens. By default, the TI-Nspire™ Navigator software creates a file named **Navigator Network mm\_dd\_yyyy** in the Documents > TI-Nspire > Navigator Network path.

3. Click **Save**, or choose another folder or file name, and then click **Save**.
4. Click **Actions > Refresh**.

**Note:** You must refresh the network status to complete the setup for the saved network.

## ***Reusing a Saved Network***

If you have to replace an access point or use a different access point, or if you reinstall the software, you can reuse a saved network. A saved network includes the list of wireless clients, the network name, and the channel selected on the access point. Reusing a saved network can save time because you do not have to set up the network again.

1. Connect the access point to the computer.
2. Click **Tools > Network Manager**.
3. Click **Actions > Apply Saved Network Setup**.

The Network Manager window opens.

The Apply a Network dialog box opens.

4. Find the network you want to reuse:
  - Browse to the location the network was saved.
  - Select the network from the list.
  - Type the name of the network in the File Name box.
5. Click **Apply**.

The network settings are applied to the access point.

## ***Checking the Network Status***

You can check the status of the network at any time in the Network Manager window.

- ▶ Click **Tools > Network Manager**.



The status updates automatically when you open the Network Manager window.
- ▶ Click **Actions > Refresh** to manually refresh the status if the Network Manager window is already open.

The network status shows the following information:

- **Access Point.** Shows whether the AP is connected or disconnected.
- **Wireless Clients.** The number of wireless clients currently connected to the network, and the number of wireless clients associated with the network.
- **Network Name.** The name you gave the network when you set it up.
- **Channel.** The access point operating channel for the current network.
- **Firmware.** The version of the access point.
- **MAC Address.** The Media Access Control address that identifies the access point.

Network Status	
Access Point:	Connected
Network Name:	0009371F0947
Channel:	11
Firmware:	3.2.0.18
MAC Address:	00:09:37:1F:09:47

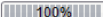
After you have set up the network, all of the adapters or cradles you added appear in the TI-Nspire™ Network Manager window. If the wireless adapter or cradle is charged and attached to a TI-Nspire™ handheld that is powered on, TI-Nspire™ Network Manager shows the status as connected. It may take up to 30 seconds to recognize the wireless client and show its status as connected. The status window also displays the battery status and signal strength.

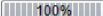
Wireless Client ID	Name	Status	Battery	Signal
<b>Wireless Clients</b>				
108687	Wireless Client	Disconnected		
112001	Wireless Client	Connected		
113261	Wireless Client	Disconnected		
113409	Wireless Client	Disconnected		
113593	Wireless Client	Connected		
114140	Wireless Client	Disconnected		
116497	Wireless Client	Disconnected		
590783	Wireless Client	Disconnected		
591224	Wireless Client	Disconnected		

If the cradle is not charged, or the adapter or cradle is not connected to a TI-Nspire™ handheld that is powered on, TI-Nspire™ Network Manager displays the status as disconnected. TI-Nspire™ Network Manager remembers the adapter and cradle IDs you added, and the next time you turn on the TI-Nspire™ handheld that is connected to the adapter or cradle, TI-Nspire™ Network Manager recognizes it.

## Identifying Selected Cradles

At times you may have a problem with one or two TI-Nspire™ Navigator™ Cradles in your network that aren't responding. When you look at the list of cradles in the TI-Nspire™ Network Manager window, you can identify which ones are not responding by the Status message, and you can see the serial numbers.

You could match the serial numbers in the window with the ones printed on the back of each wireless cradle. However, TI-Nspire™ Network Manager gives you an easier way to physically locate them. You can use the **Identify selected** command to quickly tell which cradles are working properly in your classroom.

1. From the list of hardware components in the TI-Nspire™ Network Manager window, click to select all of the working cradles. To select more than one cradle, press and hold the **Shift** or **Ctrl** key (Mac®: **⌘** key), and click the items you want to select.
2. Click **Actions > Identify Selected**.
3. Look around your classroom at the cradles in your network. Both LEDs on the cradles that you selected will blink rapidly with a green color. You can identify the cradles that are not working because their LEDs are **not** blinking.

Now that you know where the non-working cradles are, you can add the cradles to the network again.

## Cradle LEDs

The LEDs on each TI-Nspire™ Navigator™ Cradle use various colors and blink patterns to indicate data activity or power status. This can occur either when the cradles are seated in the charging bay or when they are outside the charging bay.

The LEDs indicate status as follows.



### Activity LED

Color and pattern	Meaning
Blinking green	Indicates data transfer to and from the access point.



### Battery (Power Status) LED

Color and pattern	Meaning
<b>In the charging bay</b>	
Solid amber	The battery is charging.
Solid green	Power on; charged and powered by a charging bay or power adapter.
Solid red	The battery is charging, but does not have good contact with the charging bay. Reposition the cradle so it has good contact. The LED should then turn amber to indicate it is recharging.
<b>Outside the charging bay</b>	
Blinking green	Power on; battery powered. The battery is 30% to 99% charged.
Blinking amber	Low battery (less than 30% charged).
Blinking red	Battery is critically low (less than 8% charged).

## Creating and Managing Your Teacher Account

Create your teacher account in the Teacher Preferences section of the TI-Nspire™ Navigator™ Teacher Software. A teacher account lets you log in to the TI-Nspire™ Navigator™ network from your handheld. After you create a teacher account, you can later change your password or your user name.

## Creating Your Teacher Account

1. Use the Workspace selector to choose the Class workspace.

2. Click **File > Settings > Teacher Preferences** .

The Teacher Preferences dialog box opens.

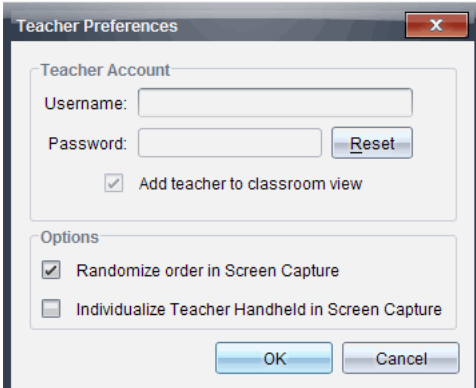

3. Type a username.

4. Type a password.

5. Select or clear the preference for the teacher icon to appear in the classroom view.

If you select this preference, the teacher icon will appear in the classroom view, and you will be included as a recipient in Send to Class, Collect from Class, and Delete from Class operations. The teacher handheld screen will be included in screen captures of the class.

6. Select or clear the options to randomize the order in Screen Capture, and to individualize the teacher handheld in Screen Capture.

- **Randomize order in Screen Capture.** Selecting this option captures and displays student screens in a random order, not the order on the class listing. This enables students to concentrate on the assignment, not whose screen they are viewing.
- **Individualize Teacher Handheld in Screen Capture.** Selecting this option shows the teacher's screen in the screen capture.

7. Click **OK**.

## Changing the Password of Your Teacher Account

1. Make sure you are not logged in to the TI-Nspire™ Navigator™ network on your handheld.

2. Click **File > Settings > Teacher Preferences** .

The Teacher Preferences dialog box opens.

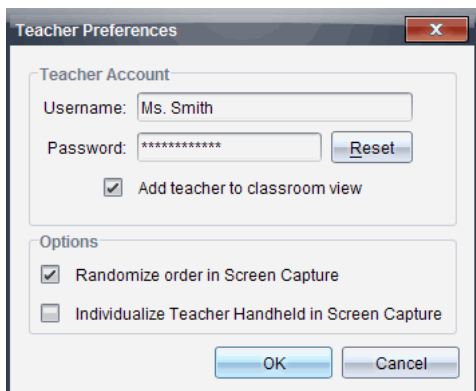

Teacher Preferences

Teacher Account

Username: Ms. Smith

Password: \*\*\*\*\* **Reset**

Add teacher to classroom view

Options

Randomize order in Screen Capture

Individualize Teacher Handheld in Screen Capture

**OK** **Cancel**

3. Click **Reset**.

TI-Nspire™ Navigator™ software clears the current password.

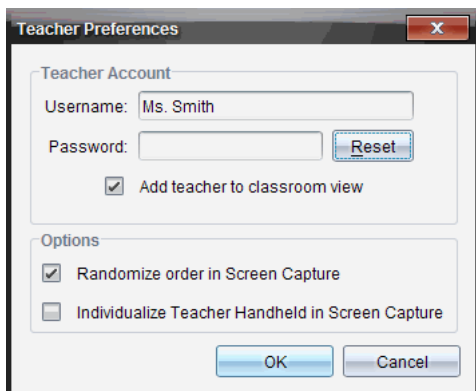

Teacher Preferences

Teacher Account

Username: Ms. Smith

Password:  **Reset**

Add teacher to classroom view

Options

Randomize order in Screen Capture

Individualize Teacher Handheld in Screen Capture

**OK** **Cancel**

4. Type a new password.
5. Click **OK**.

## Changing the User Name of Your Teacher Account

1. Make sure you are not logged in to the TI-Nspire™ Navigator™ network on your handheld.

2. Click **File > Settings > Teacher Preferences** .

The Teacher Preferences dialog box opens.

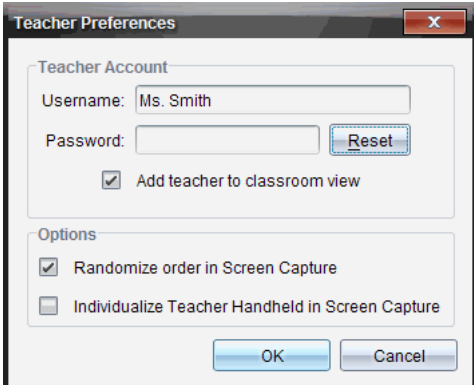

3. Enter a new user name.
4. Click **OK**.

## Logging In to the TI-Nspire™ Navigator™ System from the Handheld

The TI-Nspire™ Navigator™ classroom learning system uses both your computer and student handhelds. For you and your students to communicate using the TI-Nspire™ Navigator™ network, students must log in to the network from their handhelds.

**Note:** You do not have to log in to communicate with student handhelds; you can use the Transfer Tool to delete files or send files and operating systems to student handhelds. However, if you plan to participate from your handheld during the TI-Nspire™ Navigator™ class session, then you must log in to the TI-Nspire™ Navigator™ network from your handheld.

For more information on using a handheld, refer to the handheld guidebooks available at [education.ti.com/guides](http://education.ti.com/guides).

Before you log in, make sure these items are ready:

- You have created your teacher account in Teacher Preferences.

- You have started a class session on your computer.
- The TI-Nspire™ handheld is ready for login. (The  icon is blinking.)

Before your students log in, make sure you complete these items:

- Create student accounts.
- Provide students with the class network name, their usernames and, if necessary, their passwords.

## Logging In to the TI-Nspire™ Navigator™ Network

1. To log in, do one of the following:

- From the Home screen of your TI-Nspire™ handheld, select **5:Settings > 5:Login**.
- From a screen other than the Home screen, press **[doc]** > **8:Login**.

The last network the wireless client was associated with appears on the handheld screen.

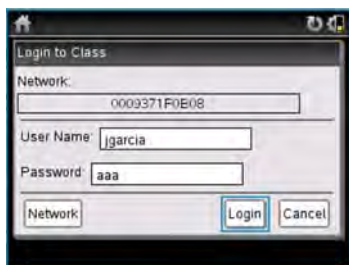

**Note:** If the handheld is connected to the computer with the USB cable, no network names appear on the screen, and you can continue logging in.

2. If the name of the network that appears is correct, continue with login. If the network is not correct, click **Network**.

The handheld screens displays all networks it has been connected to, and also displays other networks within range.





3. Select the network from the list, and then click **Connect**.

The login screen shows the connection status and displays the network name when the connection is successful.

4. Type your username and password.
5. Select **Login**.



The Login Successful screen opens.





6. Click **OK**.

### TI-Nspire™ Handheld Login Status Icons

The icons on the TI-Nspire™ CX, TI-Nspire™ CX CAS, TI-Nspire™, and TI-Nspire™ CAS handheld screens indicate the communication status between the handheld and the access point, wireless adapter, wireless cradle, or TI-Navigator™ network. The icons indicate status as follows.

Icon	Status	Meaning
No icon		If no icon appears on the handheld, the handheld is not searching for an access point. Unattach and reattach the wireless adapter or cradle.
	Blinking	The handheld is searching for an access point.
	Solid	The handheld has found an access point.

Icon	Status	Meaning
	Solid	The handheld is not communicating with the adapter or cradle. Remove the handheld from the adapter or cradle, wait for the icon to disappear, and then reattach the handheld to the adapter or cradle.
	Blinking	The handheld is connected to the network and is ready to login.
	Solid	The handheld is logged in to the network.

## ***Storing the Wireless Adapters and Cradles***

When you charge the handhelds overnight, you can leave the TI-Nspire™ Wireless Network Adapters attached to the handhelds before placing the handhelds in the TI-Nspire™ CX Docking Station. When you are ready to use the handhelds the next morning, the handheld should be fully charged, and the adapter is ready for use.

You can remove the wireless adapter from the handheld, and store the adapters in the adapter storage case overnight.

If you need to store the wireless adapters for more than two weeks, remove the wireless adapter from the handheld, and store the adapters in the adapter storage case. Place the storage case in a cool, dry place.

If you need to store the TI-Nspire™ Navigator™ Cradles for more than two weeks, remove the handhelds from the cradles, and store the cradles in a cool, dry place. You cannot damage the batteries by leaving them in the charging bay beyond the time needed to fully charge them, or by leaving them in the charging bay while the charging bay is unplugged.

# Getting Started with TI-Nspire™ Navigator™ Teacher Software

The DVD that comes with your classroom kit contains TI-Nspire™ Navigator™ Teacher Software and TI-Nspire™ CAS Navigator™ Teacher Software.

The software automatically opens upon installation, or you can start the software at any time by clicking the **Start > Programs > TI Tools** menu on a PC, or the **Applications** menu on a Mac®, and then choosing the software you purchased.

To help you get started quickly when you open the software, the Welcome Screen appears with some common task options.

To begin working with documents, click an icon or link, or close this screen manually. Any normal action that takes place automatically, such as upgrade prompts or the ability to begin using connected handhelds, appears after you close the Welcome Screen.



- ❶ **Name.** Shows software name.
- ❷ **Quick Start icons.** Click one of these icons to create a new document in the chosen application. The icon applications are Calculator, Graphs, Geometry, Lists & Spreadsheet, Data & Statistics, Question, Notes, and the Vernier DataQuest™ app. The Welcome Screen automatically closes and the chosen application opens.
- ❸ **Preview area.** When your mouse is hovering over an application icon or a link in Teacher Tools, this area shows a preview of the application or tool. A brief description of the icon or link is also displayed at the top of the area.
- ❹ **Always show this at startup.** Clear this check box to skip this screen when you open the software.
- ❺ **Close the Welcome Screen.** Click here to close this screen and begin working in the software.
- ❻ **Teacher Tools.** Click one of these links to close the Welcome Screen and open the software in the chosen tool.
  - **View content.** Opens the Content Workspace, where you can find content on your computer, the web, or connected handhelds.
  - **Manage handhelds.** Opens the Content Workspace where you can see every handheld connected to your computer as well as the status of each.
  - **Transfer documents.** Opens the Transfer Tool application in the Content Workspace, where you can send documents, folders, or new handheld OS files to the connected handhelds.
  - **View classes and students.** Opens the Class Workspace where you can see the students in a class, or add new classes and students.
  - **Open.** Opens a dialog box where you can select an existing file on your computer to open.

**Recent Documents.** Lists the names of recently opened documents. As your mouse hovers over each document name, the first page of that document is displayed in the Preview pane. Click the name of a document in the list to open that document.

## Navigating Through the Welcome Screen Icons

- ▶ Press **Tab** to navigate through the icons.
- ▶ Press **Shift + Tab** to go backward through the icons.

- ▶ Click to act on the selected icon.

As you move through the icons, the Preview area shows a preview of the application.

## Opening the Welcome Screen Manually

The Welcome Screen opens automatically when you open the software. To open the screen manually, do the following:

- ▶ Click **Help > Welcome Screen**.

## Exploring the TI-Nspire™ Navigator™ Teacher Software

When you close the Welcome Screen, the TI-Nspire™ Navigator™ Teacher Software is open to the last workspace you used. If this is your first time using the software, the Content Workspace is open by default. Workspaces are explained in more detail below.

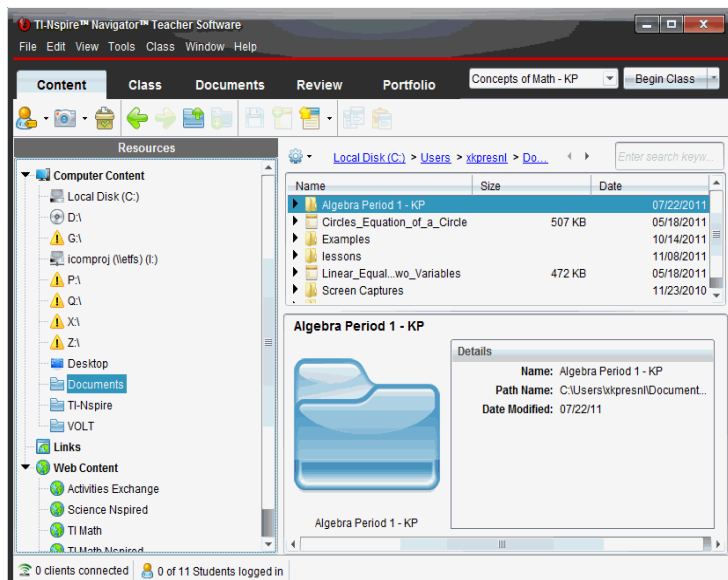

The tools described below are available in all workspaces of the TI-Nspire™ Navigator™ Teacher Software. For more information on other areas of the software, see the chapter for each workspace.

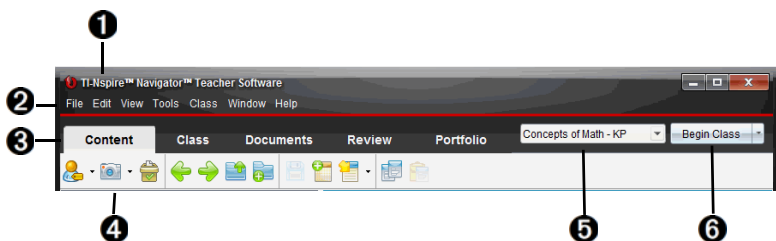

❶ **Title bar.** Shows the name of the current document and the name of the software. The minimize, maximize, and close buttons are located in the right corner.

❷ **Menu bar.** Contains tools for working with documents in the current workspace, and for modifying system settings.

❸ **Workspace Selector.** Use these tabs to switch between the Content, Class, Documents, Review, and Portfolio Workspaces.

**Note:** Some tasks you perform may prevent you from immediately changing workspaces. If a dialog box awaits a response from you, type your response and then change workspaces.

❹ **Tools menu.** Shows tools frequently used when working in each workspace. Every workspace has the Quick Poll, Screen Capture, and Student Name Format icons. Other tool menu options change depending on which workspace is open. Those tools are covered in their respective chapters.

- Student Name Format lets you choose how student names are displayed; either by Last Name, First Name, User Name, Display Name, Student ID, or hidden.
- The Screen Capture tool lets you take a picture of an active document on the computer, or capture the screen of one or all connected handhelds. You can take several pictures, and you can copy/paste and save the images. For more information, see *Capturing Screens*.

The Quick Poll tool lets you send a poll to students that they immediately receive on their handhelds, and receive student responses. For more information, see *Polling Students*.

❺ **Class list.** Lists classes that are currently available.

❻ **Class Actions button.** Use this to begin, pause, resume, or end a class.

## Exploring Workspaces

The TI-Nspire™ Navigator™ Teacher Software uses workspaces to help you easily access the tasks you most commonly perform. The TI-Nspire™ Navigator™ Teacher Software has five predefined workspaces. Each workspace is explained in additional detail in their respective chapters.

- **Content Workspace.** Find and manage content on your computer, links to websites, connected handhelds, or Texas Instruments web content.
- **Class Workspace.** Manage classes and students, use the class record panel, and exchange files with students. You can use a mix of TI-Nspire™ CX, TI-Nspire™ CX CAS, TI-Nspire™, and TI-Nspire™ CAS handhelds in the same class.
- **Documents Workspace.** Author documents and demonstrate mathematical concepts.
- **Review Workspace.** Review a collected set of documents; mark, show, or hide student responses; switch data views; and organize data.
- **Portfolio Workspace.** Save, store, review, and manage class assignments from students.

## Exploring the Status Bar

Some information in the status bar changes, depending on which workspace is open.

In all workspaces, the status bar gives you information about the network status and the student login status.

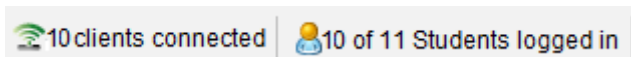

Network status

Student login status

The network status shows how many TI-Nspire™ CX Wireless Network Adapters and TI-Nspire™ Navigator™ Cradles are currently connected to the system. You can click here to launch the Network Manager window.

The student login status shows how many students are currently logged into class, and how many students are assigned to the current class.

In the Documents Workspace, the status bar gives additional information.

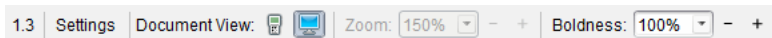

- 1 Problem and page number.** References the current document. In this example, 1.3 indicates problem 1, page 3 of the active document.
- 2 Settings.** Click here to view or change Document settings.
- 3 Document View.** Toggle between Handheld mode and Computer mode.
- 4 Zoom/Boldness.** When working with a document in Handheld mode, use the **Zoom** scale to zoom the active document in or out from 10% to 500%. To set a zoom, type a specific number, use the + and - buttons to increase or decrease by increments of 10%, or use the drop-down box to choose preset percentages.

When working with a document in Computer mode, use the **Boldness** scale to increase or decrease the boldness of text and line thickness within applications. To set the boldness, type a specific number, use the + and - buttons to increase or decrease by increments of 10%, or use the drop-down box to choose preset percentages.

In the Review Workspace, the status bar information changes, depending on the view in the Page Sorter.

- If you are in the document view, the status bar provides the same information as the Documents Workspace status bar.
- If you are in the student response view, the status bar has Data View icons. Use the icons to change between bar chart, table, and graph views. See *Using the Review Workspace* for more information on the Data Views.

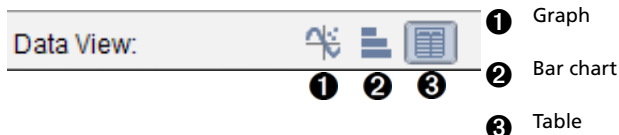

In the Class Workspace, the status bar has Student View icons. Use the icons to change between Seating Chart view or Student List view. See *Using the Class Workspace* for more information on the Student Views.



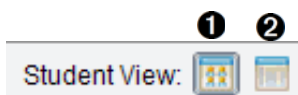

1 Seating chart

2 Student List

## Changing Language

Use this option to select a preferred language. You must restart the software for the language to take effect.

1. Click **File > Settings > Change Language**.

The Choose a Language dialog box opens.

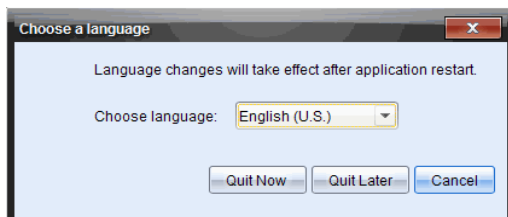

2. Click ▼ to open the Choose language drop-down list.
3. Select the desired language.
4. Click **Quit Now** to close the software immediately. You will be prompted to save any open documents. When you restart the software, the language change is effective.

—or—

Click **Quit Later** to continue your work. The language change is not applied until you close and restart the software at a later time.

**Note:** If you select Simplified Chinese or Traditional Chinese as the language in the TI-Nspire™ software, you should see Chinese characters in the menus and dialogs. If your computer uses the Windows® XP operating system and you do not see Chinese characters, you may need to install the Windows® XP East Asian Language Support package.



# Tracking and Reporting System Use

Schools participating in research-based programs or schools receiving money from funding initiatives must track student use of the TI-Nspire™ Navigator™ systems and provide reports for auditing purposes.

To automatically track student usage of the TI-Nspire™ Navigator™ systems, teachers must create a folder named "SessionLogs" within the appropriate TI-Nspire™ Navigator™ software folder on their computer. If the SessionLogs folder is present, the software generates the files needed for tracking activity types, attendance, class session information, and activities that take place during a class session. The files are dependent on each other and must be kept together in the SessionLogs folder so that usage information is tracked and reported accurately.

After the SessionLogs folder is created, the system automatically captures system usage data and appends the information for each new class session in the appropriate file. If the system does not find a SessionLogs folder, data is not tracked.

## ***Creating the SessionLogs Folder***

Using the Windows® Explorer (or Finder if using a Mac®), complete the following steps to create the SessionLogs folder.

1. Go to the My Documents (or Documents) folder on your computer.
2. Open the folder that corresponds to the software you installed. This is the default folder created when you installed your TI-Nspire™ Navigator™ software.
  - My TI-Nspire™ Navigator™ Teacher Software
  - My TI-Nspire™ CAS Navigator™ Teacher Software
  - My TI-Nspire™ Navigator™ NC Teacher Software
  - My TI-Nspire™ CAS Navigator™ NC Teacher Software
3. Create a folder named `sessionLogs`.

**Note:** The folder name is case sensitive and must be named as described.

When you start the TI-Nspire™ software, the system creates the session files and saves them in the SessionLogs folder.

Name	Date modified	Type	Size
Activities	11/4/2011 11:57 AM	Microsoft Excel Comma Separated Values File	1 KB
ActivityTypes	11/7/2011 9:41 AM	Microsoft Excel Comma Separated Values File	1 KB
Attendance	11/4/2011 11:57 AM	Microsoft Excel Comma Separated Values File	1 KB
ClassSession	11/4/2011 12:01 PM	Microsoft Excel Comma Separated Values File	1 KB

## Managing Session Logs

The system automatically generates the following comma-separated variable (csv) files and stores them in the SessionLogs folder. Each time you start the TI-Nspire™ software, logs are appended to the previous day's log to keep a complete record.

**Note:** Users are responsible for managing the size of the files.

- **ActivityTypes.csv file.** This file is the lookup table that the system references when generating a usage report.
- **Attendance.csv file.** Information for each student who logs into a session is recorded in this file.
- **ClassSession.csv file.** Information for all class sessions is recorded in this file.
- **Activities.csv file.** Activities that take place during class sessions are recorded in this file.

## Using the ActivityTypes File

The ActivityTypes file is a look-up table that includes codes for identifying activity types and a short description of each activity.

Activity ID	Description
SC	Screen Capture
CF	Collect File
DF	Delete File
SF	Send File
RD	Redistribute
SP	Save to Portfolio
CM	Collect Missing

<b>Activity ID</b>	<b>Description</b>
SM	Send Missing
US	Unprompted Send
LP	Live Presenter
QP-MC	Quick Poll - Multiple Choice
QP-OR	Quick Poll - Open Response
QP-EQ	Quick Poll - Equations
QP-CE	Quick Poll - Chemical Expression
QP-EX	Quick Poll - Expressions
QP-IL	Quick Poll - Image with labels
QP-IP	Quick Poll - Image with point(s)
QP-CP	Quick Poll - Coordinate Points
QP-LS	Quick Poll - Lists & Spreadsheet

### Using the Attendance File

The system records information for each student who logged into a session in the Attendance file. Information includes:

- **Class ID.** The Class ID number unique to the funding program.
- **Class Name.** Name of the class as defined in the software.
- **Last Name.** Last name of the student.
- **First Name.** First name of the student.
- **Date and Time.** Date and time when student logged in. Used to identify students who logged in on time versus late.

### Using the Class Session File

The system records information for each class session by Class ID. Information includes:

- **Class ID.** The Class ID number unique to the funding program.
- **Class Name.** Name of the class as defined in the software.
- **Start.** Time the class started as recorded when the teacher clicks Begin Class.
- **End.** Time the class ended as recorded when the teacher clicks End Class.

- **NumStudent.** Number of students who logged in during the class session.

## Using the Activities File

The system records information about the activities that took place during the class session in this file. Information includes:

- **Class Session ID.** Class ID number unique to the funding program.
- **Class Name.** Name of the class as defined in the software.
- **Activity Type ID.** Type of activity that took place during the class. The ID corresponds to the activity types defined in the Activity Type file.
- **Activity Detail.** Additional data about the activity type if available.
- **Activity Start.** Time the activity started.
- **Activity End.** Time the activity ended.
- **NumStudent.** Number of students who participated in this activity.

## Packaging and Sending Session Logs

The district administrator must report usage to the funding source for auditing purposes at regular intervals. When files are requested, teachers can easily package the session files into a zip file and send the file to the administrator. The zip file preserves the format and dependencies of the activity files, and includes a default file name that identifies the zip file for the administrator.

Complete the following steps to package the files in the SessionLogs folder into a zip file and send the file to the administrator.

1. From the Content Workspace, click **File > Package Session Logs**.

**Note:** This menu item is only available if the SessionLogs folder was created.

The software packages the files into a zip file and assigns a default name (TI\_PKG\_SessionLogs\_MMDDYYYY). The Logs package dialog box opens.

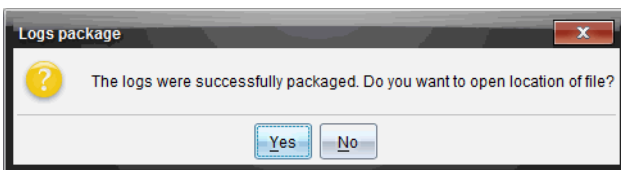

2. Click **Yes** to go to the location where the zip file was saved.

Windows® Explorer (or Finder) opens. The zip file is saved in the same location as the SessionLogs folder. For example, if you have TI-Nspire™ Navigator™ NC Teacher Software, the SessionLogs folder is stored in the following location:

PC:

...\\My Documents\\My TI-Nspire™ Navigator™ NC Teacher Software\\

Mac®

.../Documents/My TI-Nspire™ Navigator™ NC Teacher Software/

3. Email the zip file to the administrator.

Data is appended to the existing file each time you start a new session. If you no longer need the information after the files are sent to the administrator, remove them from the SessionLogs folder and keep the zip file. The system will generate new files the next time you start a new session.





# Using the Content Workspace

The Content Workspace provides access and navigation to folders and files stored on your computer, network, and external drives, allowing you to open, copy, and transfer files to students.

## Exploring the Content Workspace

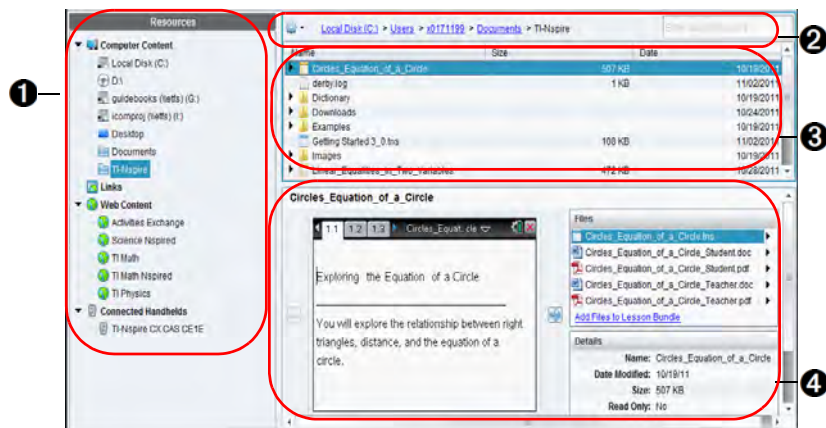

- 1 Resources pane.** Select content here. You can select folders and shortcuts on your computer, network drives, external drives, or web content. If you are using software that supports TI-Nspire™ handhelds, the Connected Handhelds heading is visible when handhelds are connected.

**Note:** You can add new links to your favorite Web sites in the Links section. You can access these new links in the Content pane. New links may not be added to the Web content section.

- 2 Navigation bar.** Navigate to any location on your computer by clicking an item in the breadcrumb trail. When you select a resource, the options shown are specific to that resource.
- 3 Content pane.** By default, the folders on your desktop are displayed. Use this space to locate and view files on your computer. You can locate and access files on a connected handheld if using software that supports handhelds. Use the top half of the space as you would a file manager. Select only one item at a time (selecting multiple items will cause an error in the Preview pane).

- 4 **Preview pane.** Shows details about the selected file or folder.

## Exploring the Resources Pane

Use the **Resources** pane to locate documents on a computer, access web content, and communicate with connected handhelds if using TI-Nspire™ software that supports connected handhelds.

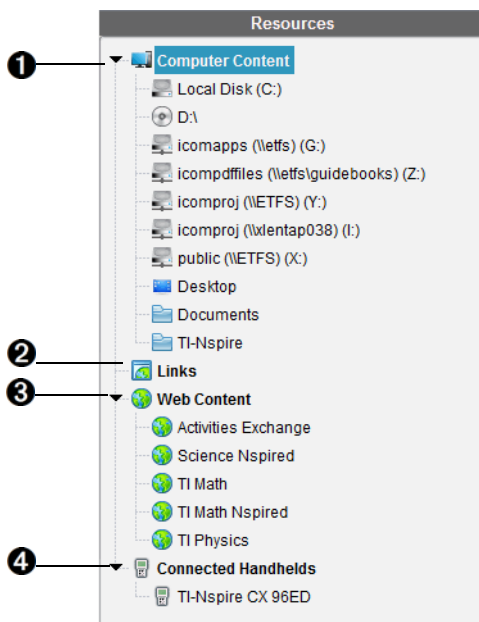

- 1 **Computer Content.** Enables navigation to all files on a computer, network drives, and external drives. Computer Content expands and collapses to provide access to the following default shortcuts:

- Local Disk
- External drives
- Network drives
- Desktop
- Documents or My Documents

When you select an item in Computer Content, the file structure appears in the Content pane. When you select a folder or supported file, the detail is displayed in the Preview pane.

- 2 Links.** By default, links to Texas Instruments sites are listed. When you click Links, it shows a list of links in the Content pane. Then when you click a link there, it launches in your web browser. You can add your own links to this section. Links from the latest version of the TI-Nspire™ software are added when you upgrade.

Users located in the United States can search U.S. standards or textbooks by selecting the search option from Links.

- 3 Web Content.** Lists links to Texas Instruments sites that contain TI-Nspire™-supported activities. Web Content is available if you are connected to the Internet. You can save material you find on these sites to your computer and share items through the Computer Content pane or Connected Handhelds if using software that supports handhelds. You cannot save links to websites in the Web Content section.

**Note:** The web content that is available varies depending on region. If there is no online content, this section is not visible in the Resources pane.

When you select an item in Web Content, the list of activities is displayed in the Content pane, and a preview of the selected activity is displayed in the Preview pane.

- 4 Connected Handhelds.** Lists handhelds connected to your computer. Click the Connected Handhelds label to view information about each handheld in the Content pane. To see folders and files on a specific handheld, click the handheld name. Connected Handhelds are not shown if there are no handhelds connected or if you are using TI-Nspire™ Navigator™ NC Teacher Software.

## Using the Preview Pane

### Lesson Bundle Example

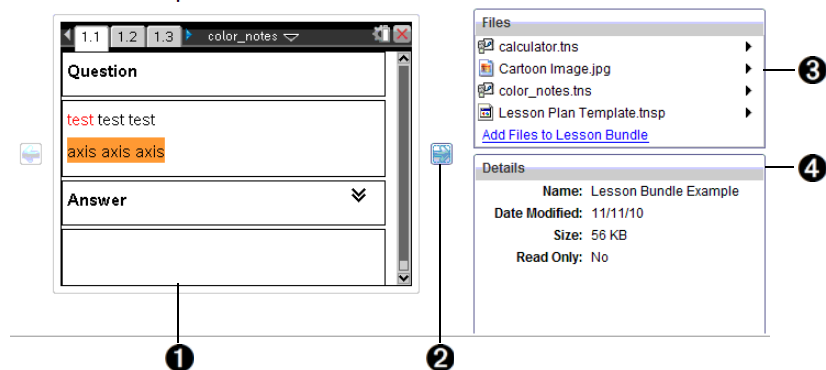

- 1 A thumbnail preview of the selected folder, .tns file, file-type icon, or lesson bundle. Double-click a file-type icon to open the file in its associated application.

**Note:** If a lesson bundle is empty and this space is blank, you have the option to add files.

- 2 If a TI-Nspire™ document has multiple pages, use the forward arrow  to preview the next page. The backward arrow becomes active so you can move backward through the pages. If working with a lesson bundle, you can choose to preview a TI-Nspire™ document within the bundle by this method.
- 3 If a lesson bundle is selected, the **Files** dialog box opens above the **Details** window listing the files in the lesson bundle. Double-click any file in a lesson bundle to open the file in its associated application.

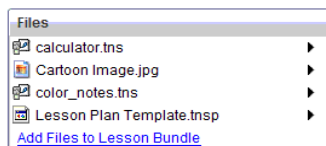

- 4 If a folder is selected, the **Details** window shows the name of the folder, the path where the folder is located, and the date modified.

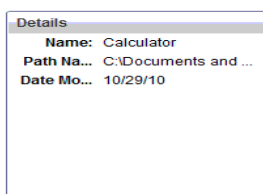

For document files and lesson bundle files, the **Details** window shows the name, the date the file was modified, the file size, and whether or not the file is read only.

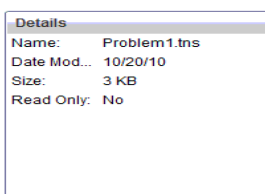

## Accessing Computer Content

Computer Content provides access to all information stored on your computer, network, and external drives.

### Using the Navigation bar

The Content pane Navigation bar provides tools needed to locate folders and files.



- 1  **Options.** Click ▼ to open the menu to access options for working with files and folders.
- 2 **Current path:** Contains a clickable breadcrumb trail of the current location. Click a breadcrumb to navigate to any section in the path.
- 3 **Search.** Enter a search keyword and press **Enter** to find all files within the selected folder containing that word.

## Filtering Computer Content

Use this filtering option for easy access and selection of your teaching content. You can select show TI-Nspire™ content only or to show all content.

1. Select a folder in Computer Content in the Resources pane.
2. From the Menu bar, select **View > Filter by**.
3. Choose one of the following options.
  - **Show TI-Nspire™ content only**
  - **Show all content**

## Mapping a Network Drive

Complete the following steps to map a network drive.

1. Select Computer Content from the Resources list.
2. Click , and then click **Create Shortcut**.

The Add Shortcut location to Content dialog box opens.

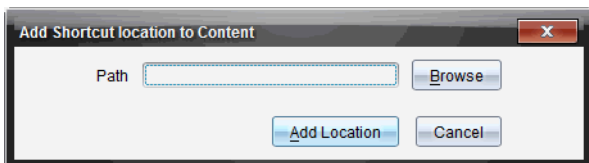

3. Click **Browse**.

**Note:** You can also type the full path name for the network drive.

The Select Shortcut Folder dialog box opens.

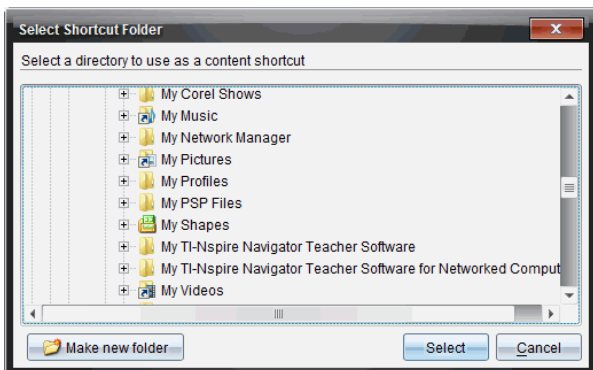

4. Navigate to the network drive.
5. Click **Select**.
6. Click **Add Location**.

The Please enter network drive credentials dialog box opens.

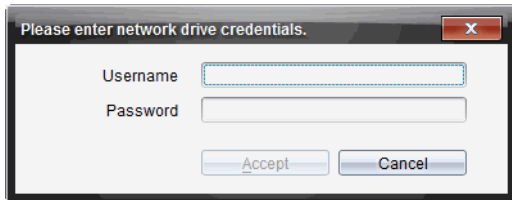

7. Type the username and password given to you by your system administrator.
8. Click **Accept**.

The network drive is added to the list of folders under the Computer Content heading in the Resources pane.

## Accessing a Secured Network Drive

If access to a network drive requires authentication, complete the following steps to access secured network.

1. Click the drive you want to access in the Resources pane.

The Please enter network drive credentials dialog box opens.

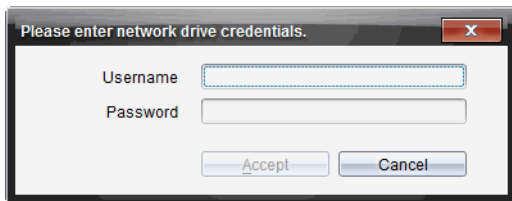

2. Type your username and password.
3. Click **Accept**.

## Using Shortcuts

Use this option to add folders or lesson bundles containing frequently used files to the Computer Content list.

### Adding a Shortcut

To add a shortcut to a folder containing files you access often:

1. Navigate to the folder where the files are located.
2. Click , and then click **Create Shortcut**.

The folder is added to the list of folders under Computer Content in the Resources pane.

## Deleting a Shortcut

To delete a shortcut:

1. From the Computer Content list, select the folder to be deleted.
2. Right-click the selected folder, and then click **Remove Shortcut**.

The folder is removed from the list of shortcuts.

**Note:** You cannot remove default shortcuts.

## Working with Links

By default, the Links list contains a list of links to Texas Instruments websites. Click a link to launch your web browser and access the website.

## Using the Links Toolbar

When you select Links in the Resources pane, the tools on the navigation bar are specific to working with links. Use these tools to add, edit, or delete links from the list. You can also move a link up or down in the list.





 **Options.** Click ▼ to open the menu to access options for working with links.

 Click this icon to add a link to the list.

 Select an existing link, and then click this icon to edit the link's attributes. You cannot edit a default link.

 Click this icon to delete a link. You cannot delete a default link.

 Select a link and click this icon to move the link up in the list.

 Select a link and click this icon to move the link down in the list.



## Adding a Link

Complete the following steps to add a link to the list of Links in the Resource pane.

1. Click .

The Add Link dialog box opens.

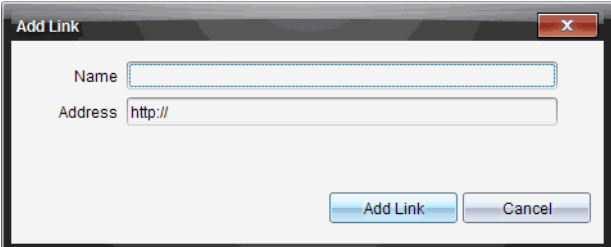

2. Type the name of the link.
3. Type the URL in the Address field.
4. Click **Add Link**.

The link is added to the bottom of the list of existing links.

## Editing an Existing Link

Complete the following steps to edit an existing link.

1. Select the link you want to change.
2. Click .

The Edit Link dialog box opens.

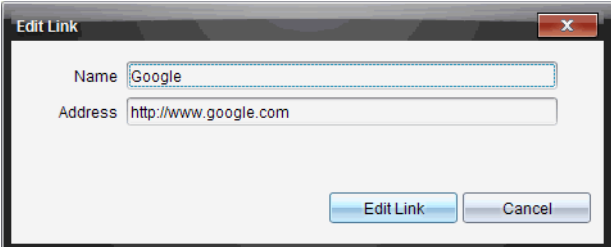

3. Make needed changes to the name of the link or to the URL.
4. Click **Edit Link**.

The changes are applied to the link.

## Removing a Link

Complete the following steps to delete a link.

1. Select the link you want to delete.
2. Click .
3. Click **Remove**.





The confirmation dialog box opens.

The link is removed from the list.

**Note:** You cannot delete a default link.

## Moving Links Up or Down in the List

You can change the order of the links in the list to suit your needs.

- ▶ Click  to move a selected link up one place in the list.
- ▶ Click  to move a selected link down one place in the link.
- ▶ Click , and then select **Move to Top of List** to relocate a selected link to the top of the list.
- ▶ Click , and then select **Move to Bottom of List** to relocate a selected link to the bottom of the list.

## Using Web Content

Web Content provides links to online materials on Texas Instruments websites. You can save material found on these websites to your computer and share them using the Computer Content pane and Connected Handhelds.

Information provided for each activity includes the name of the activity, the author, the date the activity was posted, the size of the file, and the source.

The screenshot shows a web application interface with the following components:

- 1** Navigation toolbar: Located at the top left, containing filters for Subject, Topic, and Category.
- 2** Column headings: Located at the top of the activity list, including Name, Author, Date Posted, Size, and Source.
- 3** List of available activities: A table listing various activities such as 'Geometry Tools & Matrices', 'Data & Statistics', and 'Using Sliders and Reference Material for Discovering Basic'.
- 4** List of the files contained in the activity: A section titled 'Save this Activity to Computer' showing a file named 'GeometryToolsMatrices.pdf'.
- 5** Details about the selected activity: A 'Details' section providing information about the selected activity, including Name, Author, Date Posted, Size, Source, Activity Time, Device, Grade Level, and Subject.

- 1 Navigation toolbar.
- 2 Column headings.
- 3 List of available activities.
- 4 List of the files contained in the activity.
- 5 Details about the selected activity.

**Note:** An Internet connection is required to access Texas Instruments websites.

## Sorting the List of Activities

Use the column headings to sort the information in the list of activities. By default the list is displayed in alphabetical order by Name.

- Click the Name heading to list activities in reverse alphabetical order. Click the heading again to return to A to Z order.
- Click the Author heading to list the activities in alphabetical order by author name.
- Click the Date Posted heading to list the activities in order from newest to oldest or from oldest to newest.
- Click the Size heading to list the activities according to file size.
- Click the Source heading to list the activities in order by source.

- Right-click the column heading row to customize displayed column headings.

## Filtering the List of Activities

By default, all available activities are listed in the Content pane. Options on the Navigation bar enable you to filter the activities by subject, topic, and category. You can also search for an activity using a keyword search.

To find all activities related to a particular subject:

1. In the Subject field, click ▼ to open the drop-down list.
2. Select a subject.  
All activities related to the selected subject are listed.
3. To narrow the search, click ▼ in the Topic field to view and select a topic related to the subject selected.
4. Use the Category field to narrow the search even further. Click ▼ to select a category related to the selected subject and topic.

## Using Keywords to Search for an Activity

Complete the following steps to search for an activity using a keyword or phrase.

1. Type a keyword or phrase in the Filter by Keyword field.
2. Press **Enter**.  
All activities that contain the keyword or phrase are listed.

## Opening an Activity

1. Select the activity you want to open.
2. Click , and then select **Open**.

The Open Activity dialog box opens with a list of all documents related to the selected activity.

You can open a .tns or .tsnp file in the TI-Nspire™ software. Other files such as Microsoft® Word and Adobe® PDF files open in their respective applications.

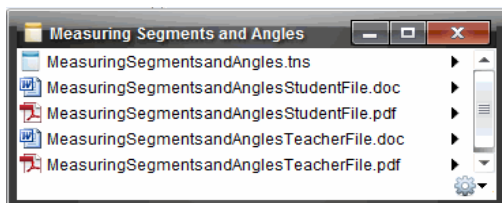

3. Select the file and click ►, and then select **Open**.
  - The .tns file opens in the Documents Workspace.
  - The .doc or .pdf file opens in its associated application.

## Saving an Activity to Your Computer

Complete the following steps to save an activity to your computer.

1. Select the activity you want to save. The file details are displayed in the bottom half of the window.

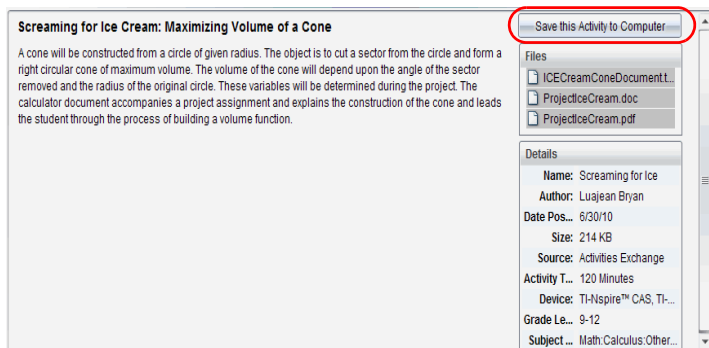

2. Click **Save this Activity to Computer** in Preview pane, above Files.

**Note:** You can also right-click on the selected activity and choose **Save to Computer**.



The Save Selected files dialog box opens.

3. Navigate to the folder where you want to save the file.
4. Click **Save**.

The activity is saved to your computer as a lesson bundle.

## Copying an Activity

Complete the following steps to copy an activity. Once the activity is copied to the Clipboard, you can paste the activity into a folder on your computer, and then drag the activity to your list of shortcuts in the Local Content pane.

1. Click the activity you want to copy to select it.
2. Use one of the following methods to copy the activity to the Clipboard:
  - Select the activity and drag it to a folder in the Local Content list.
  - Click , and then click **Copy**.
  - Right-click on a file in the Files list, and then click **Copy**.
  - Click  (Copy icon), which is located in the toolbar.

The activity is copied to the Clipboard.

3. Open a folder on your computer, and then click **Edit > Paste** to copy the activity to the selected folder.

## Sending Files to Class

You can send files and folders to your whole class, members of the class currently logged in, or to individual students. Class must be in session for you to send the files.

When you send a file to the whole class, all students currently logged in will receive the file immediately. Students not logged in will receive the file when they log in.

### Notes:



- Only TI-Nspire™ (.tns), PublishView™ (.tnsp), LearningCheck™ (.edc), and CABRI™ (.fig) file types open in the TI-Nspire™ software.
- File types .edc and .fig are converted to .tns files when they are sent to the class.
- Other file types (if supported) such as images, word processing, or spreadsheet files, open in the application the operating system has associated with the file type.

## Sending Files from the Content or Documents Workspaces

1. Select the file you want to send to the class.
  - From the Content Workspace, click the file in the Content pane.
  - From the Documents Workspace, click the file in the Content Explorer.

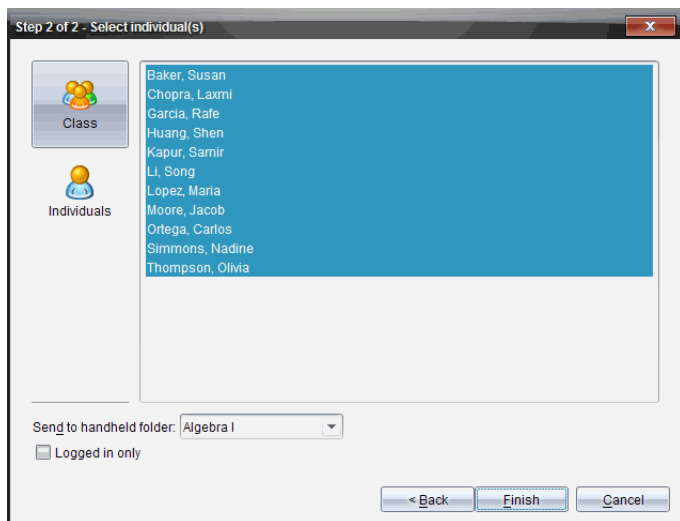
2. Click **Send to Class** , or click **File >Send to > Send to Class**.  
The Select individual(s) dialog box opens.



3. Select the student(s) to whom you want to send the file:
  - To send the file to the whole class, click **Class** . To send the file only to class members who are currently logged in, select the **Logged in only** check box.
  - To send the file to an individual student, click **Individuals**  and then click the student.  
**Note:** If you had any students selected in the classroom area, the software already has them selected.
  - Use the **Send to handheld folder** drop-down list to choose from the current class folder, the top level folder on the handheld, or the last 10 folders that files were sent to. (Available only on TI-Nspire™ software that supports handhelds.)

4. Click **Finish**.

The file transfer appears in the Class Record in the Class Workspace.



# Working with Connected Handhelds

The TI-Nspire™ software enables you to view content, manage files, and install operating system updates on handhelds connected to the computer.

To use the features described in this chapter, handhelds must be turned on and connected by one of these means:

- TI-Nspire™ Docking Station
- TI-Nspire™ Navigator™ Cradle and access point
- TI-Nspire™ CX Wireless Network Adapter and access point
- A direct connection through a standard USB cable

**Note:** The tasks in this section can only be performed using TI-Nspire™ handhelds.

## Viewing Content on Connected Handhelds

When you select a handheld in the Resources pane in the Content Workspace, all files and folders on the handheld appear in the Content pane. To preview the document contents, select **Click here to preview document** in the Preview pane.

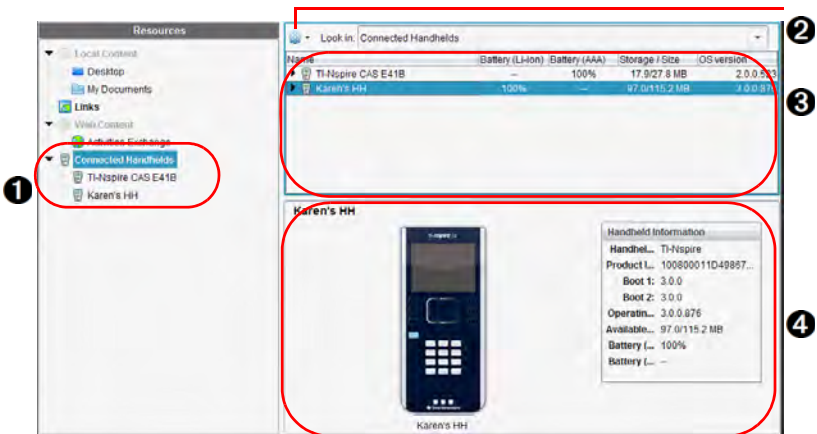

- ❶ **Connected Handhelds** - Lists all handhelds that are connected and turned on.
- ❷ **Options** - Available options vary depending on the task you select under Resources.
- ❸ **Content pane** - When Connected Handhelds is selected, the Content pane shows details about handhelds that are connected and turned on:
  - **Handheld Type:** Names of handhelds.
  - **Product ID:** Handheld product identification.
  - **Boot 1:** Internal bootstrap that performs lower level operation for booting up device.
  - **Boot 2:** External bootstrap that performs lower level operation for booting up device.
  - **Operating System:** The operating system in use.
  - **Available Space:** The amount of space left and available on the handheld.
  - **Battery (Li-ion):** Li-ion (rechargeable) battery charge (Critical 2%, 25%, 50%, 75%, 100%, or "--" to indicate no battery is present).
  - **Battery (AAA):** AAA battery charge (Critical 2%, 25%, 50%, 75%, 100%, or "--" to indicate no battery is present).
- ❹ **Preview pane** - Provides information on a handheld when you click Connected Handhelds in the Resources pane and then a handheld in the Content pane. If you select a TI-Nspire™ file in the Content pane, the Preview pane shows a preview available for that file.

When you select a handheld, all files and folders on the handheld appear in the Content pane. When a file or folder is selected, the details are displayed in the Preview pane. Click the icon to preview the document.

Name	Size
▶ 7th Period Geometry	
▶ Algebra	
▶ Algebra I	
▶ Algebra II	
▶ Examples	
00 Getting Started.tns	9 KB
01 Percentage Explorer.tns	12 KB
02 Introducing Functions.tns	8 KB
03 Linear Equations Explorer.tns	10 KB
04 Systems of Equations Explorer.tns	11 KB
05 Introducing Geometry.tns	19 KB

Details about the selected folder or file are shown in the Preview pane.

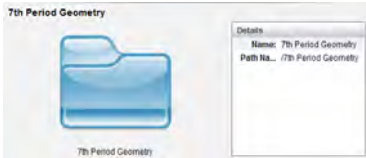

Details for selected folder

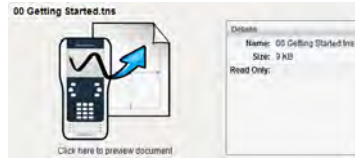

Details for selected file

- ▶ To view the files in a folder, double-click the folder name in the Content pane. The files in the folder are listed in the Content pane.
- ▶ To preview the contents of a .tns file, select **Click here to preview document** in the Preview pane.

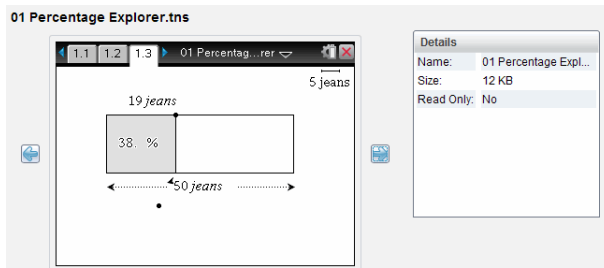

## Managing Files on a Connected Handheld

When working with files on connected handhelds in the Content

Workspace, use the Options menu  or the context menu to manage files.

**Note:** If you select a file type that is not supported on the handheld, some selections in Options menu are not active.

---

Option	How it Works
Open	Open a file on a connected handheld: <ul style="list-style-type: none"><li>• Click the file you want to open.</li><li>• Click <b>Open</b>. The document opens in the Documents Workspace.</li></ul>

---

Option	How it Works
Save to Computer	<p>Save a copy of the selected file on your computer:</p> <ul style="list-style-type: none"> <li>• Click the file you want to save.</li> <li>• Click <b>Save to Computer</b>. The Save Selected Files dialog box opens.</li> <li>• Navigate to the folder where you want to save the file.</li> <li>• Click <b>Save</b>.</li> </ul>
Copy/Paste	<p>Create a copy of a file:</p> <ul style="list-style-type: none"> <li>• Click the file you want to copy.</li> <li>• Click <b>Options &gt; Copy</b> to copy the file to the Clipboard.</li> <li>• To paste the file in another location, navigate to the new location, and then click <b>Options &gt; Paste</b>.</li> </ul> <p><b>Note:</b> If you don't select a new location, the copied file is pasted with a new name "Copy of ..."</p>
Delete	<p>Delete a file on a connected handheld:</p> <ul style="list-style-type: none"> <li>• Click the file you want to delete.</li> <li>• Click <b>Delete</b>.</li> <li>• Click <b>Yes</b> when the Warning dialog box opens. Click <b>No</b> to cancel.</li> </ul>
Refresh	<p>To refresh the list of files, click <b>Options &gt; Refresh</b>.</p>
Rename	<p>To rename a file on a connected handheld:</p> <ul style="list-style-type: none"> <li>• Click the file you want to rename.</li> <li>• Click <b>Options &gt; Rename</b>.</li> <li>• Type the new name and press <b>Enter</b>.</li> </ul>
Up a Level	<p>Go up a level in the folder hierarchy. This option is available when you select a file inside a folder.</p>
New Folder	<p>Create a new folder:</p> <ul style="list-style-type: none"> <li>• Click <b>New Folder</b>.</li> <li>• Type a name for the new folder.</li> <li>• Press <b>Enter</b>.</li> </ul>

## Opening Documents on a Connected Handheld

To open a document on a connected handheld in the TI-Nspire™ software:

1. Ensure the handheld is connected to your computer.
2. Click  to open Content Explorer.  
The connected handheld name is listed in the Connected Handhelds pane.
3. Double-click the handheld name.  
The folders and documents on the handheld are listed.
4. Navigate to the document you want to open, and then double-click the file name.  
The document opens in the Documents Workspace.

## Saving Files to a Connected Handheld

When you save a file from your computer to a handheld, files are converted to TI-Nspire™ documents (.tns files). To save a file on your computer to a connected handheld:

1. Ensure the handheld is connected to your computer.
2. Click  to open Content Explorer.  
The folders and files on your computer are listed in the Computer pane.
3. Navigate to the folder or file you want to save to the handheld.
4. Click the file to select it.
5. Drag the file to a connected handheld listed in the Connected Handheld pane.  
The file is saved to the connected handheld.

**Note:** To save the file in a folder on the handheld, double-click the handheld name to list the folders and files, and then drag the file to a folder on the handheld.

If the file already exists on the handheld, a dialog box opens asking if you want to replace the file. Click **Replace** to overwrite the existing file. Click **No** or **Cancel** to abandon the save.

## ***Sending Files to Handhelds***

You can transfer activities, folders, lesson bundles, and supported files from a computer to connected handhelds, from one connected handheld to another, or from one connected handheld to all connected handhelds.

Items you can transfer include:

- Folders
- Supported files

.tns	.edc	.fig	.tco
.tnc	.tno	.tilb	.tcc

**Note:** File types .edc and .fig are converted to .tns files when they are sent to the handheld.

### **Sending an Activity to a Connected Handheld**

In the Content Workspace, you can send an activity from the Web Content link to connected handhelds.

1. Use the Workspace selector to select the Content Workspace.
2. Click Web Content in the Resources pane.
3. Click the activity you want to send to connected handhelds.
4. Use one of the following options to send the file to the selected handhelds:
  - Drag the file to the Selected Handhelds label to transfer to the file to all connected handhelds. To transfer the file to a specific handheld, drag the file to a specific handheld name.
  - To transfer the file using Transfer Tool:

**Note:** You cannot use the Transfer Tool to transfer files to handhelds while a class is in session.

- From the toolbar, click  , and then select **Send to Connected Handhelds**.

—or—

- Click  , and then select **Send to Connected Handhelds**.

The Transfer Tool opens.

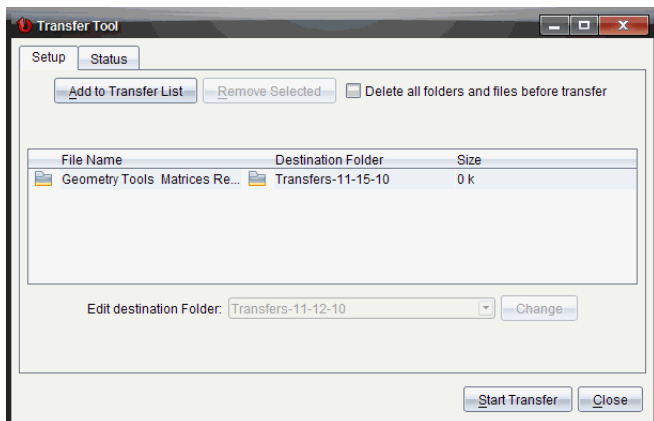

5. Select the file, and then click **Start Transfer**.  
The selected files and folders are transferred to the selected handhelds.
6. When the transfer is complete, close the Transfer Tool.

### **Sending Files to all Connected Handhelds**

You can send a file to all connected handhelds when a class is not in session. To transfer files or folders from a connected handheld or from the computer to all connected handhelds, complete the following steps:

1. Use the Workspace selector to select the Content Workspace.
2. Select the files or folders you want to transfer from the Resources pane.

**Note:** You can choose files from Computer Content, Web Content, or Connected Handhelds.

3. Click , and then click **Send to Connected Handhelds**.

The Transfer Tool window opens.

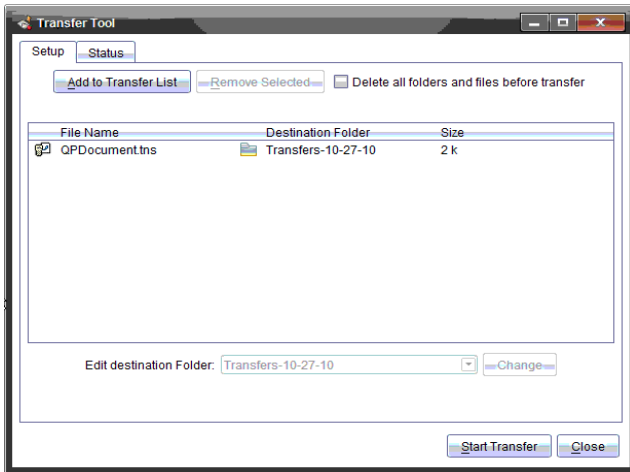

4. Click **Start Transfer**.

**Note:** To add additional files to the transfer list, click **Add to Transfer List**.

The selected files and folders are transferred to the connected handhelds. By default, the files are transferred to a folder on the handheld titled *Transfers-m-d-yy*.

## Transferring Files Between Handhelds

If multiple handhelds are connected, you can send a folder or file from one handheld to another handheld in the Connected Handhelds list in the Resources pane.

1. Use the Workspace selector to select the Content Workspace.
2. In the Resources pane, click the handheld that contains the files you want to transfer. The files on the handheld are listed in the Content pane.
3. Click the folder or file you want to send.
4. Drag the file to another handheld in the Connected Handhelds list.

**Note:** You can also copy and paste a file from one handheld to another.

## Checking for an OS Update

When handhelds are connected, you can check for OS updates from the Content Workspace or from the Documents Workspace.

**Note:** Your computer must be connected to the Internet.



1. Show all connected handhelds.
  - In the Content Workspace, click **Connected Handhelds** in the Resources pane.
  - In the Documents Workspace, open the Content Explorer and click **Connected Handhelds**.
2. Click the handheld you want to check, and then click **Help > Check for Handheld/Lab Cradle OS Update**.
  - If the operating system is current, the Check for Handheld OS Update dialog box opens indicating that the operating system on the handheld is current.

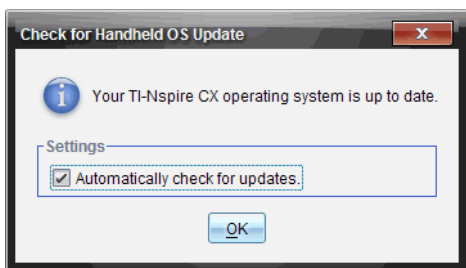

- If the operating system is not current, the TI-Nspire™ software prompts you to install the latest OS now, with the option to download the OS to your computer.

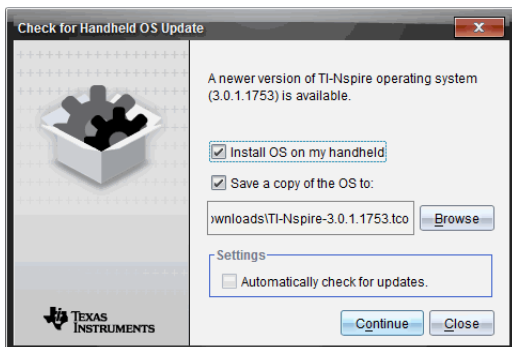

3. To turn off automatic notifications, clear the **Automatically check for updates** check box.
4. Click **OK** to close the dialog box, or click **Continue** and follow the prompts to install the OS on the handheld.

## Installing an OS Update

When handhelds are connected, you can install OS updates from the Content Workspace or from the Documents Workspace.

**Note:** Updating the operating system does not replace or remove documents.

Ensure you have downloaded the latest operating system file. Go to [education.ti.com/latest](http://education.ti.com/latest) to download the latest operating system files.

### Updating the OS on a Single Handheld

1. Show all connected handhelds.
  - In the Content Workspace, click **Connected Handhelds** in the Resources pane.
  - In the Documents Workspace, open the Content Explorer and click **Connected Handhelds**.
2. Click the handheld you want to update, and then choose the install option.
  - In the Content Workspace, right-click the handheld, and then click **Install Handheld/Lab Cradle OS**.
  - In the Documents Workspace, click , and then click **Install Handheld/Lab Cradle OS**.

The Select Handheld OS File dialog box opens.

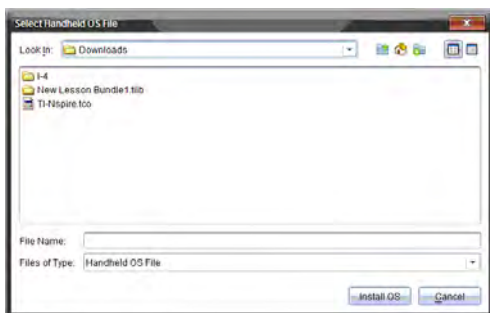

3. Navigate to the folder on your computer where the operating system file is located.

**Note:** The TI-Nspire™ software automatically shows the OS type for the selected handheld.

4. Click **Install OS**.

- Click **Yes** to confirm you want to continue the update.
- Wait while the software is downloaded to the selected handheld, and then follow prompts on the handheld to finish the OS update.

## Updating the OS on Multiple Handhelds

- In the Content Workspace, click **Computer Content** in the Resources pane.
- Click **Tools > Install Handheld/Lab Cradle OS**.

The Select Handheld OS File dialog box opens.

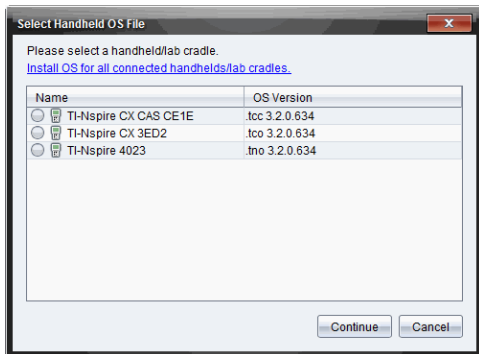

- Click **Install OS for all connected handhelds/lab cradles**.

**Note:** You can also update an individual OS by clicking the radio button next to the handheld name, and then clicking **Continue**.

The OS Installation dialog box opens.

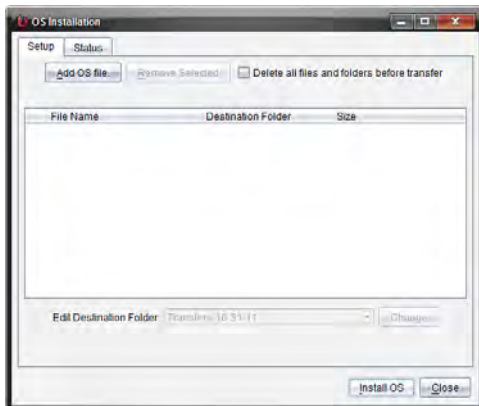

- Click **Add OS File**.

The Add to Transfer List dialog displays.

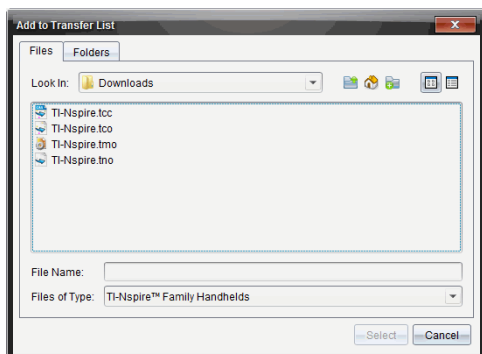

5. Navigate to the folder on your computer where the operating system file is located.
6. Select the applicable OS files.
  - To upgrade a TI-Nspire™ CX handheld, select TI-Nspire.tco.
  - To upgrade a TI-Nspire™ CX CAS handheld, select TI-Nspire.tcc.
  - To upgrade a TI-Nspire™ handheld, select TI-Nspire.tno.
  - To upgrade a TI-Nspire™ CAS handheld, select TI-Nspire.tnc.
7. Click **Select**.

The OS Installation redisplays with your selected OS files.

8. Click **Install OS**.

The OS version information updates, and the Select OS Handheld File dialog redisplays for further selection.

## ***Renaming Handhelds***

You can rename the handhelds from the Content Workspace.

**Note:** Renaming a handheld does not affect student login information.

1. Right-click the handheld name in the Content pane.
2. Click **Rename**.
3. Type the new name.
4. Press **Enter** to go to the next name to change.

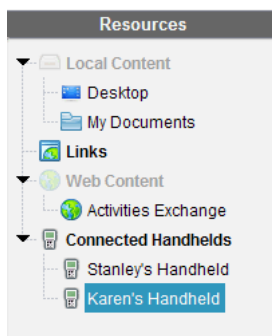

5. To exit the Edit mode, click an area of the screen outside the handheld names. You will also leave the Edit mode after you press **Enter** on the last name you edit.

### ***Using Identify Selected to Locate Handhelds***

If you are using the TI-Nspire™ Docking Station or the TI-Nspire™ CX Docking Station, use this feature to locate handhelds.

1. Be sure that the handhelds are turned on and that the docking station is connected to your computer.
2. Use the Workspace selector to select the Content Workspace.
3. Click **Tools > Identify Selected Handheld/Lab Cradle** or right-click the handheld name in the Content pane.

Both LED lights on the docking station under the slot where the handheld is located will blink for 30 seconds.



# Using the Class Workspace

Use this workspace to add and manage classes and students, and to exchange files with students.

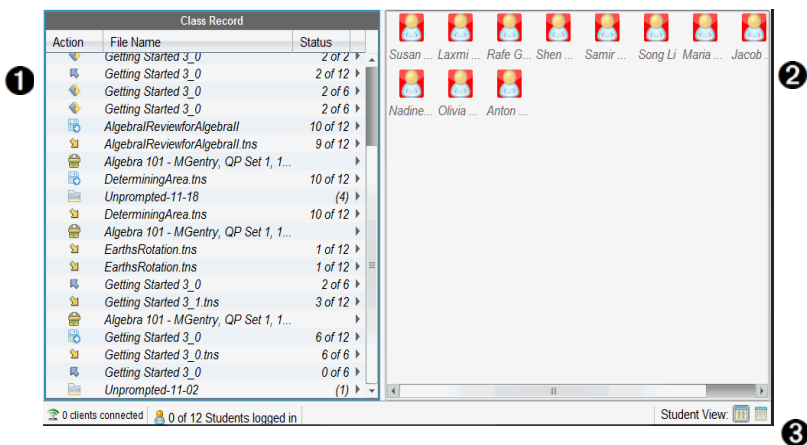

- 1 Class Record.** Document actions are shown here. You can open a document in the Review Workspace; save a document to the Portfolio Workspace; collect files from the Class Record Workspace; send and delete files using the toolbar, and view document properties in Record Item Properties.
- 2 Classroom area.** Shows the students in your class, which ones are logged in, and the status of file transfers for selected files in the Class Record. You can view the students by Seating Chart or by Student List.
- 3 Student View.** Lets you show the students in the classroom area in Seating Chart view or Student List view.

## Adding Classes

When you start using the TI-Nspire™ software, one of the first things you should do is create your classes. Make sure you create a class for each of the class periods you plan to teach.

If this is your first time using the TI-Nspire™ software, the classroom area may be empty. You can complete the following steps at any time.

The Add Classes Wizard guides you through the process of setting up classes. The software prompts you to add a class, and to add students to the class. You can choose to add classes manually or using a CSV file.

## Adding Classes Manually

1. Use the Workspace selector to select the Class Workspace.

2. Click **Class > Add Classes** or click .

The Add Classes dialog box opens.

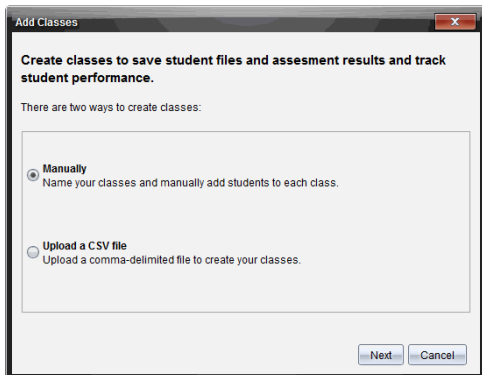

3. Select **Manually** from the Add Classes dialog box.

4. Click **Next**.

The Add Classes Manually dialog box opens.

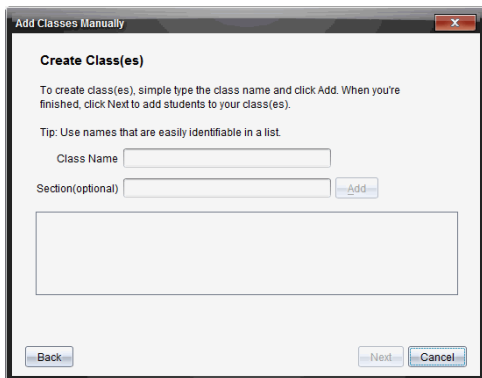



5. Type a Class Name. If needed, you can also provide a Section.

**Note:** It is a good idea to append a unique identifier such as the course ID or the teacher name to the class name. This helps the student select the correct class if there are, for example, multiple Algebra I classes running.

6. Click **Add**.

The Add Classes Manually dialog box shows the class listed.

7. Continue adding classes, and click **Next** when you are done.

A dialog box displays showing successful class creation and asking if you want to add students.

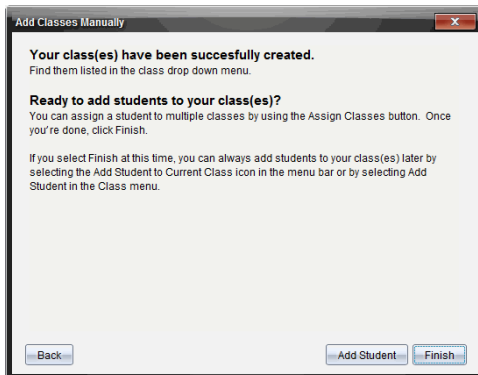

8. Click **Add Student**.

**Note:** Click **Finish** to Add Students later.

## Adding Classes with a CSV Upload

You can add classes with a CSV upload, and import a list of students into the class. Use the CSV upload option to import student information from a comma-separated values (CSV) file or a text (.txt) file.

The CSV or .txt file should have this information:

Class Name  
Section Name (optional)  
Student First Name  
Student Last Name  
Student User Name  
Student ID (optional)  
Password (optional)

1. Use the Workspace selector to select the Class Workspace.

2. Click **Class > Add Classes** or click .

The Add Classes dialog box opens.

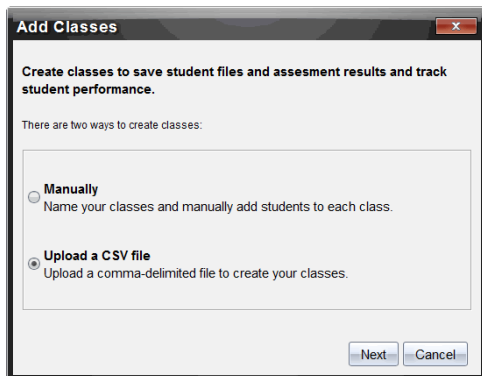

3. Select **Upload a CSV file** from the Add Classes dialog box.
4. Click **Next**.

The Add Classes by Uploading a CSV File dialog box opens.

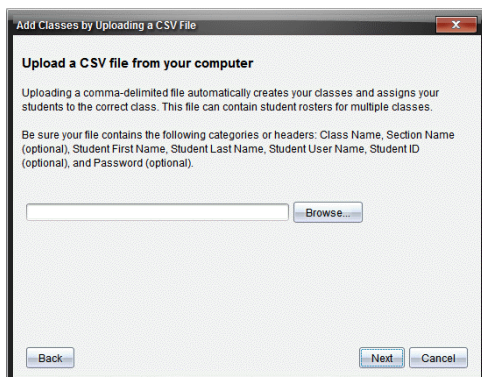

5. Click **Browse** to navigate to the file on your computer.
6. Select the file that contains the students you want to import.
7. Click **Open**.

The Add Classes by Uploading a CSV File dialog box shows the file.

8. Click **Next**.

The Mapping fields dialog box opens.

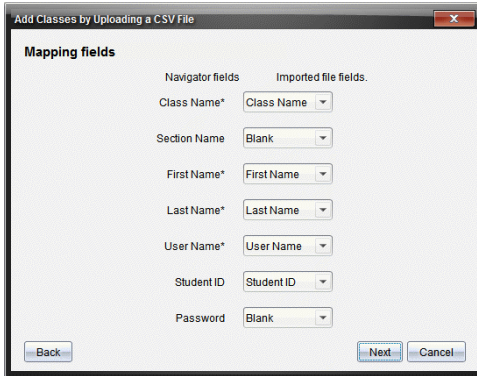

9. Click ▼ and select a field from the drop-down lists to map the headings in your comma-delimited file.

10. Click **Next**.

A dialog box opens showing completion status.

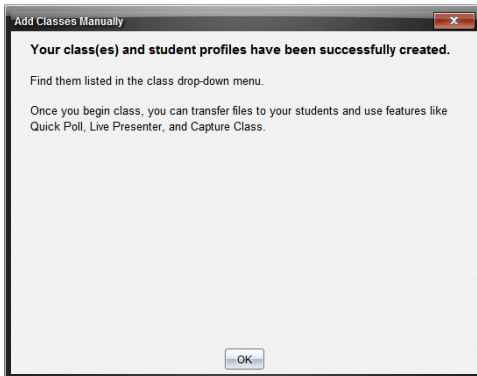

11. Click **OK** to close

**Note:** If some students did not import successfully, click **View Details** to determine the problem.

## ***Adding Students to Classes***

After you create classes, you need to add students to the classes. You can add students to an active class session, or you can add students to any class at any time.

**Note:** These instructions explain how to add students after you create a class.

1. Select the class to which you want to add students.
  - If class is in session, the student will be added to the current class. You have the option of adding the student to other classes.
  - If class is not in session, use the Class Session controls to select the class to which you want to add the student.

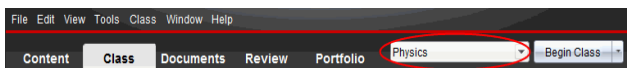

2. Click **Class > Add Student** or click .

The Add Student dialog box opens.

A screenshot of the 'Add Student' dialog box. The dialog has a title bar with 'Add Student' and a close button (X). It contains several input fields: 'First Name:', 'Last Name:', 'User Name:', 'Password:' (with a radio button for 'Student Chooses' and a blank password field), 'Display Name:', and 'Student ID:'. Below these fields is a 'Classes:' label with 'Algebra I' selected and an 'Assign Classes' button. At the bottom are three buttons: 'Add Next Student', 'Finish', and 'Cancel'.

3. Type the student's first name and last name.
4. Type a user name.  
**Note:** The user name you choose must be unique. It cannot exist in the current class or any other class.
5. If you want your student to create their own password, select **Student Chooses**.

—or—

If you want to create a password for your student, select the blank password entry box and type a new password.

6. (Optional) Type a display name.  
**Note:** If you leave the display name blank, the software uses the student's first name as the display name.
7. (Optional) Type a student ID.

8. (Optional) Assign the student to other classes:

- Click **Assign Classes**.

The Assign Classes dialog box opens.

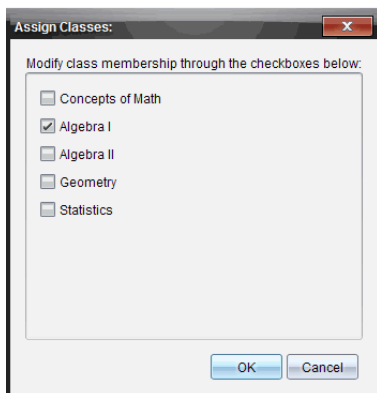

- Select the check boxes of the student's classes.
- Clear the check boxes of the classes to which the student does not belong.
- Click **OK**.

The Add Student dialog box opens.

9. If you need to add another student, click **Add Next Student** and repeat steps 3 – 8.

10. When all students are added, click **Finish**.

## ***Removing Students from Classes***

As necessary, you can remove students from your classes. When you remove students, the TI-Nspire™ software only removes them from the selected class. If the students are in other classes, they remain in those classes until you remove them.

### **Notes:**

- You cannot remove students who are logged in to the TI-Nspire™ Navigator™ network.
- You cannot undo the removal of students.
- You can access many of the student account items by right-clicking the student icon in the classroom area and choosing an action from the menu.

To remove a student from a class:

1. Click the student you want to remove.
2. Click **Class > Remove Student**, or click .

The software asks if you are sure you want to remove the student.

3. Click **Yes**.

The software removes the student.

## **Updating Class Rosters**

You can update a single or multiple class rosters with new student information by importing a CSV file with updates.

**Note:** You cannot change existing student information or remove students already in the TI-Nspire™ Navigator™ database.

You can import a comma-separated value (CSV) file or a \*.txt file. The CSV or .txt file should have this information:

Class Name  
Section Name (optional)  
Student First Name  
Student Last Name  
Student User Name  
Student ID (optional)  
Password (optional)

1. Use the Workspace selector to select the Class Workspace.
2. Select the class for which you want to update the roster.

**Note:** Class cannot be started.

3. Click **Class > Update Class Roster**.

The Update Class Roster dialog box opens.

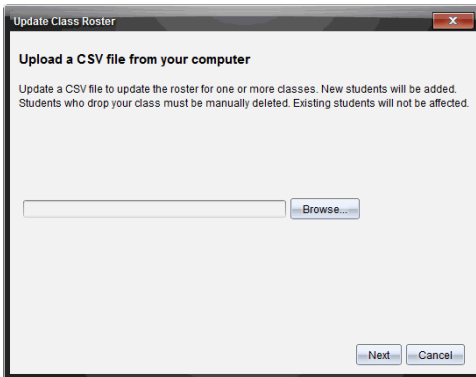

4. Click **Browse** to navigate to the file on your computer.
5. Select the file that contains the new students you want to import.
6. Click **Open**.

The Update Class Roster dialog box shows the file.

7. Click **Next**.

The Mapping fields dialog box opens.

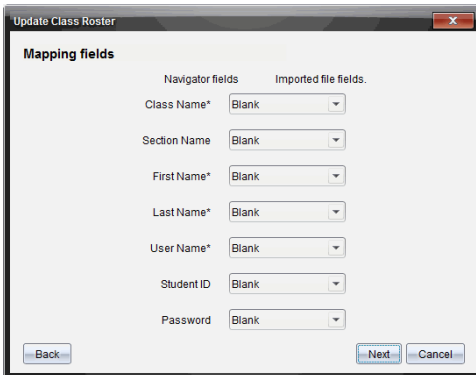

8. Click ▼ and select a field from the drop-down lists to map the headings in your comma-delimited file.
9. Click **Next**.

A dialog box displays showing completion status.

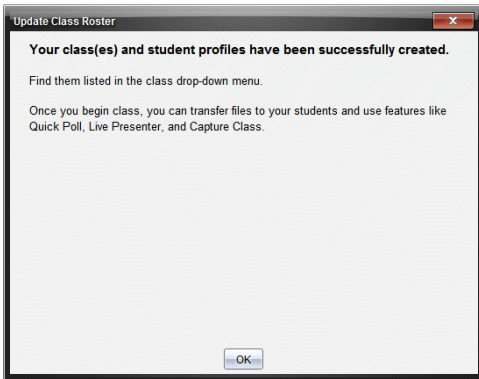

10. Click **OK** to close.

**Note:** If some students did not import successfully, click **View Details** to determine the problem.

## ***Managing Classes***

You can delete classes and remove all class information from the TI-Nspire™ Navigator™ database. You can also choose to hide or show classes in menus and views.

### **Deleting a Class**

When you delete a class, the software removes the class and removes the files on the hard drive that correspond to that class. If you have students who are not part of any other classes, the software removes those students as well.

**Note:** You cannot undo the removal of a class.

1. If you have a class session running, end it.
2. Click **Class > Manage Classes**.

The Manage Classes dialog box opens.



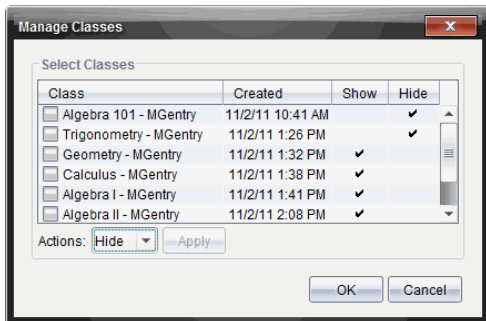

- From the Class list, select the class you want to remove.
- Select **Delete** from the Actions list.
- Click **Apply**.

The software asks if you are sure you want to remove the class.

- Click **OK**.

## Hiding a Class

When you hide a class, the class is removed from all workspace views and menus except for the Manage Classes dialog box.

**Note:** Hidden classes are not deleted from the TI-Nspire™ Navigator™ database.

- Click **Class > Manage Classes**.

The Manage Classes dialog box opens.

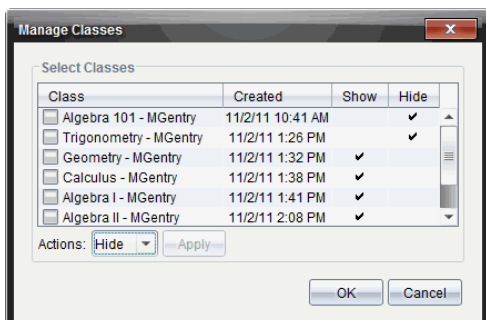

- From the Class list, select the class you want to hide.
- Select **Hide** from the Actions list.

4. Click **Apply**.

The software asks if you are sure you want to hide the class.

5. Click **OK**.

**Note:** Select **Show** from the Actions list when you want the class to show again.

## ***Beginning and Ending a Class Session***

A class session is the period of time the TI-Nspire™ software is active for a specific class. While a class session is running, you can perform communication functions with the selected class. You cannot use software to interact with your class until you begin a class session, and you cannot begin another class until you end the current one.

### **Beginning a Class Session**

1. Click **Class > Select Class**, or click the Classroom Session list.

A list of available classes opens.

2. Select the class you want to begin.
3. Click **Begin Class**.

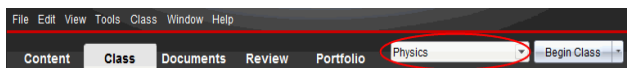

### **Ending a Class Session**

When class is over, or before you start another class, you need to end the current class session. Ending a class stops all communication between your computer and the students. When you end a class, students receive a message saying class is ended, and students are automatically logged off.

- ▶ To end a current class session, select **End Class** from the Class Actions dropdown list.

### **Pausing a Class Session**

This function is available only on TI-Nspire™ software that supports handhelds. There are times you may want to pause a class. If using TI-Nspire™ software that supports handhelds, pausing a class suspends all activity on student handhelds, and they receive a message telling them class is paused. When you resume class, the message clears and students are able to use their handhelds. The students remain logged in when you pause a class.

1. To pause a class in session, click **Pause Class**.









- To resume the class, click **Resume Class**.

## Changing the Student View

In the classroom area, you can view the students in the selected class in either the Student List view or the Seating Chart view. The Student List view shows students in a table that contains their display names, first name, last name, user name, and student ID. The Seating Chart view shows students as student icons with display names. You can change the class view at any time.

### Changing the Class View to Student List

- Click **View > Student List** or click  in the status bar. The view changes to Student List.

Picture	Display Name	First Name	Last Name	User Name	Student ID
	Olivia Thompson	Olivia	Thompson	101	1
	Laxmi Chopra	Laxmi	Chopra	202	10
	Carlos Ortega	Carlos	Ortega	203	11
	Maria Lopez	Maria	Lopez	102	2
	Samir Kapur	Samir	Kapur	103	3
	Jacob Moore	Jacob	Moore	104	4
	Song Li	Song	Li	105	5
	Susan Baker	Susan	Baker	106	6
	Shen Huang	Shen	Huang	107	7
	Nadine Simmons	Nadine	Simmons	108	8
	Rafe Garcia	Rafe	Garcia	201	9

### Changing the Class View to Seating Chart

- Click **View > Seating Chart** or click  in the status bar. The view changes to Seating Chart view.



## Arranging the Seating Chart

Initially, students are arranged in the Seating Chart view in the order that you added them. However, you can rearrange the students so that they have the same seating arrangement in the classroom area as they do in your actual classroom. You can rearrange the seating chart at any time.

### Arranging Students in the Seating Chart

1. Select the class from the Class Session list.
2. Click **View > Seating Chart**.

The classroom area shows your class in the Seating Chart view.

3. Within the classroom area, drag each student icon to the location that you want.



The software moves the student icons to the new locations.

The software remembers the student positions the next time you start the same class.

**Note:** Do not place one student icon on top of another student icon. If you do this, you will only be able to see one of the student's icons.

### Checking Student Login Status

You can view the students' login status from the Seating Chart view. The color of the icon by the student display names indicates their login status as well as the class status:

Icon	Class status	Student status	Color
	Class session not started.	N/A	Grey
	Class session started.	Student not logged in.	Light blue
	Class session started.	Student logged in.	Dark blue

## Sorting Student Information

The Student List view in the classroom area shows the information for students in the selected class. It includes display names, first names, last names, user names, and student IDs. In the Student List view, you can sort student information by each of these categories. Information is sorted alphabetically from A-Z or Z-A and numerically from 1-9 or 9-1. You can sort student information at any time.

### Sorting Student Information

1. Select the class that contains the student information you want to sort.

**Note:** If you have a class session running, you must end it to select the class.

2. In the menu, click **View > Student List**.
3. Click the column title of the list you want to sort.

The software sorts the selected list.

4. To sort the selected information in the opposite order, click the column title again.

## Changing the Classes Assigned to a Student

Occasionally your students may move to a different class, or they may take more than one of your classes. You can change student classes when necessary.

**Note:** You cannot change the classes of students who are logged in to the TI-Nspire™ Navigator™ network.

### Changing a Student's Class

1. Select a class to which the student belongs.
2. Click the student you want to edit.
3. Click **Class > Edit Student**, or click .

The Student Properties dialog box opens.

The screenshot shows a dialog box titled "Student Properties" with a close button (X) in the top right corner. It contains several input fields and buttons:

- First Name:
- Last Name:
- User Name:
- Password:  with a "Reset" button next to it.
- Radio buttons:  Student Chooses and  (with a masked password field - Display Name:
- Student ID:
- Classes: **Algebra I** (highlighted) with an "Assign Classes" button to its right.
- Buttons: "OK" and "Cancel" at the bottom.

4. Click **Assign Classes**.

The Assign Classes dialog box opens.

The screenshot shows a dialog box titled "Assign Classes:" with a close button (X) in the top right corner. It contains a list of classes with checkboxes and buttons:

- Modify class membership through the checkboxes below:
- Concepts of Math
- Algebra I
- Algebra II
- Geometry
- Statistics
- Buttons: "OK" and "Cancel" at the bottom.

5. Select the check boxes of the student's classes.
6. Clear the check boxes of the classes to which the student does not belong.
7. Click **OK**.
8. In the Student Properties dialog box, click **OK**.

## Changing Student Names and Identifiers

After you add students, you may find that you need to change one of their names or identifiers. There are five different names and identifiers associated with your students, including:

- First name
- Last name
- User name
- Display name
- Student ID

This section covers how to change any of these types of names and identifiers.

**Note:** You cannot change the account information of students who are logged in to the TI-Nspire™ Navigator™ network.

**Note:** You can access many of the student account items by right-clicking the student and choosing an action from the menu.

### Changing Student Names or Identifiers

1. Select a class to which the student belongs.

**Note:** If you have a class session running, you must end it to select the class.

2. Click the student you want to edit.
3. Click **Class > Edit Student**, or click .

The Student Properties dialog box opens.

4. Click the field of the name or identifier you want to change.
5. Make the necessary changes.
6. Repeat steps 4 and 5 for any other names or identifiers you want to change.
7. Click **OK**.

## ***Moving Students to Another Class***

If any of your students move to a different class, you can move them within the TI-Nspire™ software as well.

**Note:** You cannot move students who are logged in to the TI-Nspire™ Navigator™ network.

**Note:** You can access many of the student account items by right-clicking the student and choosing an action from the menu.

### **Moving a Student to Another Class**

1. Select a class to which the student belongs.
 

**Note:** If you have a class session running, you must end it to move the student.
2. Click the student you want to move.
3. Click **Edit > Cut** or click .

The software removes the student from the class and moves the student account information to the Clipboard.



4. From the Class Session list, select the class where you want to move the student.

5. Click **Edit > Paste** or click .

The software moves the student to the selected class.

## ***Copying Students to Another Class***

When you have students in more than one of your classes, you may find it convenient to copy them from one class to another. Copying students saves you the time of entering all of their information again.

**Note:** You cannot copy students who are logged in to the TI-Nspire™ Navigator™ network.

**Note:** You can access many of the student account items by right-clicking the student and choosing an action from the menu.

### **Copying a Student to Another Class**

1. Select a class to which the student belongs.

**Note:** If you have a class session running, you must end it to select the class.

2. Click the student you want to copy.

3. Click **Edit > Copy** or click .

The software copies the student to the Clipboard.





















4. From the Current Class dropdown list, select the class to which you want to copy the student.

5. Click **Edit > Paste** or click .







The software copies the student to the selected class.

## ***Exploring the Class Record***

From the Class Record, you can open a document in the Review Workspace; save a document to the Portfolio Workspace; collect files from the Class Record Workspace; send and delete files using the toolbar; and view document properties in Record Item Properties for all TI-Nspire™ documents, except Quick Poll files.

Class Record		
Action	File Name	Status
	AlgebraTest1	4 of 4
	AlgebraTest1.tns	4 of 4
	Concepts of Math - KP...	
	Homework3	0 of 1
	AlgebraTest2.tns	1 of 1
	Concepts of Math - KP...	
	Concepts of Math - KP...	
	Concepts of Math - KP...	
	Concepts of Math - KP...	
	Lists	1 of 1
	AlgebraTest2.tns	1 of 1
	Lists.tns	1 of 1
	AlgebraTest1	0 of 1
	AlgebraTest1	2 of 2
	AlgebraTest1	2 of 2
	AlgebraTest1	2 of 2
	AlgebraTest1.tns	2 of 2
	Concepts of Math - KP...	
	Concepts of Math - KP...	
	Concepts of Math - KP...	

**1 File action.** The icons indicate the status of a file.

-  Sent to class
-  Collected from class
-  Saved to portfolio
-  Redistributed to class
-  Quick Poll
-  Unprompted
-  Deleted

**2 File name.** The names of files used in this class.

3 **Status.** The progress of an action. For example, "23 of 25" indicates that 23 out of 25 students have received a file.

4 **Menu options.** Click  for quick access to certain menu items. This icon gives you the same options as a right-click.

## ***Sending Files to a Class***

You can send files and folders to your whole class, members of the class currently logged in, or to individual students. Class must be in session for you to send the files.

When you send a file to the whole class, all students currently logged in will receive the file immediately. Students not logged in will receive the file when they log in.

### **Notes:**

- Only TI-Nspire™ (.tns), PublishView™ (.tnsp), LearningCheck™ (.edc), and CABRI™ (.fig) file types open in the TI-Nspire™ software.
- File types .edc and .fig are converted to .tns files when they are sent to the class.
- Other file types (if supported) such as images, word processing, or spreadsheet files, open in the application the operating system has associated with the file type.

1. Click **Tools > Send to class** or click .

The Select file(s) to send dialog box opens.

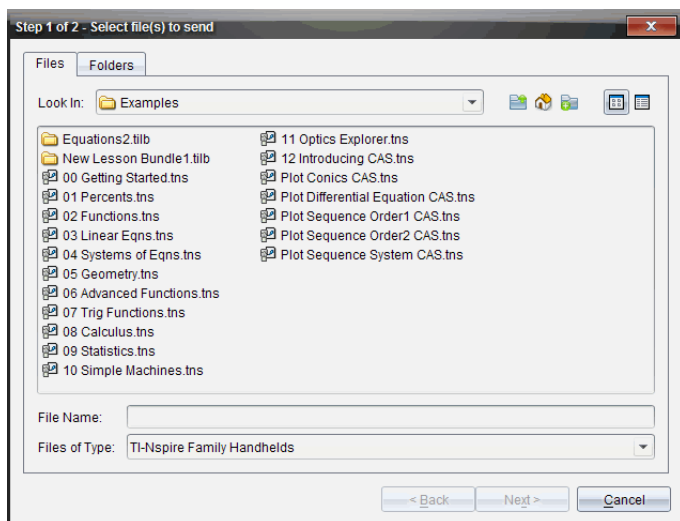

2. Click the **Files** tab to choose files, or click the **Folders** tab to choose folders.

**Note:** You can send only files or folders, not a combination of files and folders.

- TI-Nspire™ Navigator™ Teacher Software for handhelds transfers only .tns files.
- TI-Nspire™ Navigator™ Teacher Software for network computers transfers all files.

3. To choose the files or folders you want to send, do one of the following:

- Navigate to the file or folder you want to send and click it. To select multiple files or folders, press and hold the **Ctrl** key (Mac®: ⌘) while clicking each file name.
- Type the name of the file or folder in the **File name** or **Folder name** box. Folder names may use alphanumeric characters. You can enter slashes ( / and \ ), but double slashes ( // and \\ ) and some special characters ( ? | : \* " < > | ) are not allowed.



**Note:** You can also drag files from a file browser window to the Class Record to send files.

4. Click **Next**.

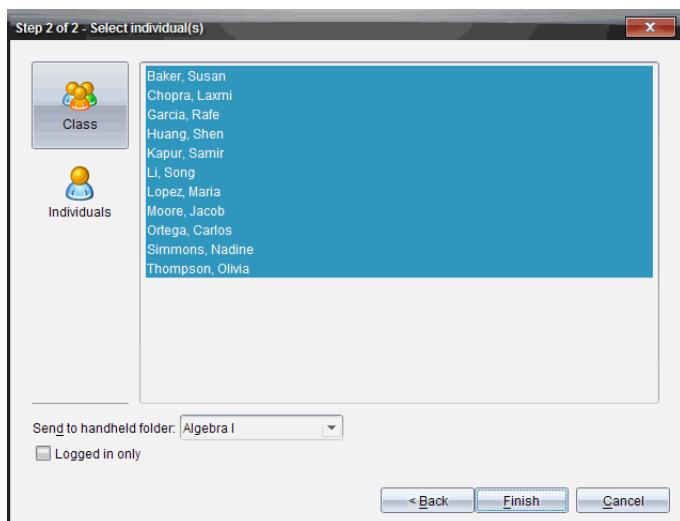
The Select individual(s) dialog box opens.



5. Select the student(s) to whom you want to send the file:

- To send the file to the whole class, click **Class** . To send the file only to class members who are currently logged in, select the **Logged in only** check box.
- To send the file to an individual student, click **Individuals** , and then click the student.

**Note:** If you had any students selected in the classroom area, the software already has them selected.

- Use the **Send to handheld folder** drop-down list to choose from the current class folder, the top level folder on the handheld, or the last 10 folders that files were sent to. (Available only on TI-Nspire™ software that supports handhelds.)
  - You can also enter a folder name path in the drop-down list.

6. Click **Finish**.

The file transfer appears in the Class Record.

## Sending Missing Files

The Send Missing function becomes active after you have completed the original transfer. This function resends files to only those students who were not logged in or targeted for the original transfer.

1. From the Class Record, select the send action of file that was sent to class.

**Note:** The send action cannot be active.

2. Click **File > Send Missing**.

### **Redistributing Selected Files to Class**

The Redistribute Selected to Class function allows you to review, modify and send selected assignments back to your students.

1. From the Class Record, select the collect action of the modified original file or files.
2. Click **File > Redistribute Selected to Class**.

**Note:** It will only send files back to student's collected from.

### **Collecting Files from Students**

You can collect any previously sent files located in student class folders by using the Class Record. You can also collect new files from students by typing the full file name.

When you collect files from the menu or icon, you have the option of deleting the collected files from student class folders.

**Note:** If a student deleted a file, renamed a file, or stored it in another location, the file cannot be collected.

To collect files, class must be in session. If any students are not logged in, files you collect are automatically transferred when they log in.

### **Collecting Files from the Class Record**

1. From the Class Record, choose the file or files that have been sent to class.

Class Record		
Action	File Name	Status
	AlgebraTest1	4 of 4
	AlgebraTest1.tns	4 of 4
	Concepts of Math - KP...	
	Homework3	0 of 1
	AlgebraTest2.tns	1 of 1
	Concepts of Math - KP...	
	Concepts of Math - KP...	
	Concepts of Math - KP...	
	Concepts of Math - KP...	
	Concepts of Math - KP...	
	Lists	1 of 1
	AlgebraTest2.tns	1 of 1
	Lists.tns	1 of 1
	AlgebraTest1	0 of 1
	AlgebraTest1	2 of 2
	AlgebraTest1	2 of 2
	AlgebraTest1	2 of 2
	AlgebraTest1.tns	2 of 2
	Concepts of Math - KP...	
	Concepts of Math - KP...	
	Concepts of Math - KP...	

- Click next to any of the highlighted files and choose **Collect Selected from Class**.

The file transfer appears in the Class Record.

## Collecting Files from the Menu or Icon



- Click **Tools > Collect from Class** or click .
 

The Select file(s) to collect dialog box opens.
- To choose the files or folders you want to collect, do one of the following:
  - Click **Recent Files** and navigate to the file you want to collect and click it. To select multiple files or folders, press and hold the **Ctrl** key (Mac@: ⌘) while clicking each file name.
  - Click **Enter Filename** and type the name of the file in the **File name** box, and then click **Add**.
- Click **Next**.
 

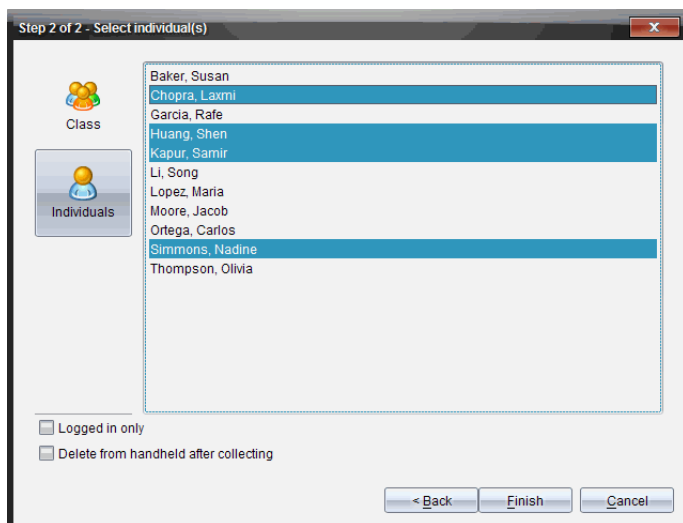
The Select individual(s) dialog box opens.



4. Select the student(s) from whom you want to collect the file:

- To collect the file from the whole class, click **Class** . To collect the file only from class members who are currently logged in, select the **Logged in only** check box.
- To collect the file from an individual student, click **Individuals** , and then click the student.

**Note:** If you had any students selected in the classroom area, the software already has them selected.

5. If you want to remove the file from student handhelds after you collect it, select the check box next to the option to delete the file after it is collected. (Available only on TI-Nspire™ software that supports handhelds.)
6. Click **Finish**.

The collected file appears in the Class Record.

## Collecting Missing Files

The Collect Missing function becomes active for files that have not been received from students.

1. From the Class Record, select the collect action of file that was sent to class.



2. Click **File > Collect Missing**.

**Note:** The collection action cannot be active.

## ***Managing Unprompted Actions***

When a student logged into a class session sends you a file outside of a collection, an Unprompted action is created.

These files, which are stored in a database, are shown in the Class Record until they are removed.

### **Reviewing and Opening Unprompted Actions**

Unprompted actions are named "Unprompted" followed by the month and date. Each class session contains all .tns and .tnsp files sent from students in one Unprompted folder.

The latest Unprompted action appears at the top of the Class Record for the most recent files sent by a student during a class session. During the next class session, more recent Unprompted actions appear in the Class Record above the previous action.

To open the Unprompted action:

1. Double-click the action or right-click and choose **Record Item Properties**.

The Unprompted dialog box opens. By default, no items in the Unprompted action are selected.

2. In the Unprompted dialog box, you can view one or more items, save the items to the Portfolio Workspace, remove the items, export the items to another file location, or do nothing.

### **Viewing Items in an Unprompted Action**

1. From the Unprompted dialog box, select the check box to the left of the item(s) you want to view.

**Note:** You can also click the **View** icon beside an item to quickly access the item.

2. Click **View**.

The items open as read-only files.

## Removing Individual Items from an Unprompted Action

Unprompted actions remain in the Class Record until you remove them. Even if you have exported or saved items, its Unprompted action continues to show until you remove it. To remove items from an Unprompted action:

1. In the Class Record, double-click the Unprompted action to open it.
2. From the Unprompted dialog box, select the check box to the left of the item(s) you want to remove.
3. Click **Remove**.

## Exporting Unprompted Action Items

You can export items from the database to the file system. To export items from an Unprompted action:

1. In the Class Record, double-click the Unprompted action to open it.
2. Select the files you want to export.
3. Click **Export**.  
A file browser opens.
4. Select the location for the export.
5. Click **Select Folder**.

## Saving Files to a Portfolio Record

You can save collected and unprompted files to a Portfolio record.

1. From the Class Record, select the files.
2. Click  and select **Save selected to Portfolio**.  
The **Save to Portfolio** dialog box opens.
3. Select to save the files to a new Portfolio column or add them to an existing Portfolio column.
  - To add the files to a new Portfolio column, click **Add as new portfolio column** and type the name for the new Portfolio column.
  - To save the files to an existing Portfolio column, click **Add to existing portfolio column** and select the column name you want from the drop-down list.

- Click **Save**.

**Note:** The files you saved in the Portfolio Workspace are shown in the Class Record until you remove them using the Remove command.

## Deleting Files from Class Folders

When necessary, you can delete files from student class folders. You can delete files that were sent to the class or collected from the class. Class must be in session for you to delete files.

**Note:** Deleting a file only removes the specified file from the class folder. If the student saved a copy with another name, or copied the file to another location, the student still has access to the file.

- Click **Tools > Delete from class** or click .

The Select file(s) to delete dialog box opens.

- To choose the files you want to delete, do one of the following:



- Click **Recent Files** and navigate to the file you want to delete and click it. To select multiple files or folders, press and hold the **Ctrl** key (Mac@: ⌘) while clicking each file name.
- Click **Enter Filename** and type the name of the file in the **File name** box, and then click **Add**.

- Click **Next**.

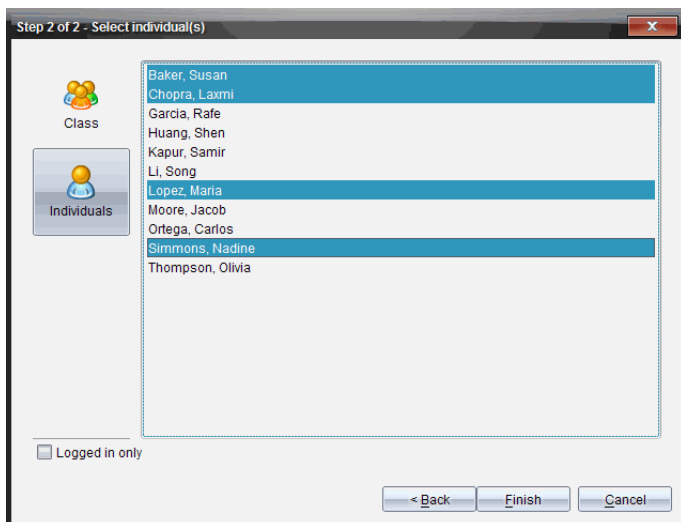
The Select individual(s) dialog box opens.



4. Select the student(s) whose files you want to delete.

- To delete the file from the whole class, click **Class** . To delete the file only from class members who are currently logged in, select the **Logged in only** check box.
- To delete the file from an individual student, click **Individuals** , and then click the student name.

**Note:** If you had any students selected in the classroom area, the software already has them selected.

5. Click **Finish**.



The file deletion appears in the Class Record.

## ***Checking the Status of File Transfers***

When you send, collect, or delete files, you may want to check to see which of your students have received or sent their files.

► In the Class Record, click the file whose status you want to check.

In the classroom area, the software indicates the status of students as follows:

-  A green background indicates that students have sent/received/deleted the file.
-  A yellow background indicates that students received the collect or delete action, but they do not have the file in their class folder.
-  A red background indicates that students have not yet sent/received/deleted the file.

**Note:** You can also see the file transfer status in the file's Properties dialog box.

## ***Canceling File Transfers***

If you change your mind about a file transfer, you can cancel the transfer in the Class Record. Canceling file transfers stops the software from transferring more files. Any files that transfer before you cancel remain in student class folders.

1. In the Class Record, click the file whose transfer you want to cancel.

2. Click **Edit > Remove from Class Record**.

The software asks if you are sure you want to remove the action.

3. Click **Remove**.

The software stops the file transfer and removes the file from the Class Record list.

## Viewing File Properties

Each file that you send or collect has a set of properties that you can view, except for Quick Poll files. File properties include name, size, date sent, and status. You can view the file properties at any time.

1. Select the file in the Class Record.
2. Right-click the file name and select **Record Item Properties**.

The Statistics Properties dialog box opens showing the file properties.

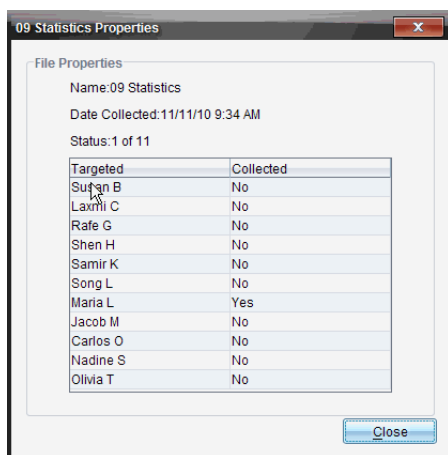

## Resetting Student Passwords

Because the TI-Nspire™ software maintains the privacy of student passwords, you cannot retrieve passwords for your students if they forget them. However, you can reset student passwords. You can reset passwords for all of the students in a class or for individual students.

**Note:** You cannot reset the passwords of students who are currently logged in to the TI-Nspire™ Navigator™ network.

## Resetting Passwords for all Students in a Class

1. Select the class.

**Note:** Student(s) must be selected to perform a successful reset of the password.

2. Click **Class > Reset Student Password(s)**.

The Confirm Reset Student Passwords dialog box opens.

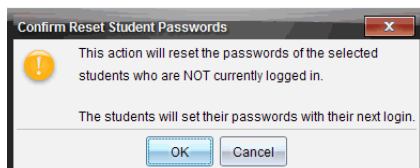

3. Click **OK**.
4. The next time students log in, instruct them to type a new password.

## Resetting Passwords for Individual Students

1. Click the student you want to edit.
2. Click **Class > Edit Student**, or click , or right-click the student name and choose **Edit Student** from the menu.

The Student Properties dialog box opens.

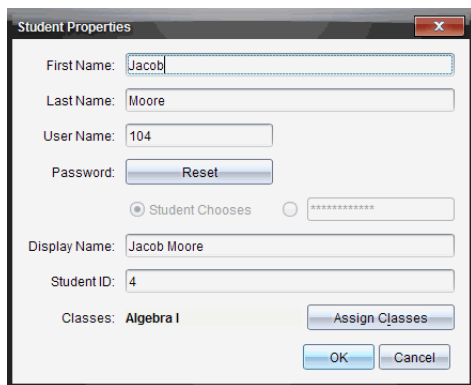

3. Click the **Reset** button next to **Password**.

4. If you want a student to create their own password, select **Student Chooses**.

—or—

If you want to create a specific password for the student, select the blank password entry box and type a new password.

5. Click **OK**.

The software resets the student's password.

6. The next time the student logs in:
  - If you selected Student Chooses, instruct the student to type a password.
  - If you created a password for the student, tell the student the new password.





# Capturing Screens

Screen Capture enables you to:

- **Capture Class**
  - View and monitor all student screens at one time, which allows you to ensure all students are on track with an assignment.
  - Capture one or several student screens for discussion in the classroom. You can hide student names to focus the discussion on the lesson or concept, and not on individuals.
  - Select and display an individual student screen and view work as a live presentation.
  - Capture screen stacks that enable you to check student progress or collect student assignments for later review.
  - Save captured images as .jpg, .gif, or .png files, which can be inserted into TI-Nspire™ applications that allow images.
- **Capture Page**
  - Capture the active page in a TI-Nspire™ document from the software or from the TI-SmartView™ emulator as an image.
  - Save captured images as .jpg, .gif, .png, or .tif files, which can be inserted into TI-Nspire™ applications that allow images.
  - Copy and paste images into another application such as Microsoft® Word.
- **Capture Selected Handheld**
  - Capture the current screen on a connected handheld as an image.
  - Save captured images as .jpg, .gif, .png, or .tif files, which can be inserted into TI-Nspire™ applications that allow images.
  - Copy and paste images into another application such as Microsoft® Word.
- **Capture Images in Handheld Mode**
  - In the Documents Workspace, use the DragScreen feature to capture the emulator screen or side screen when the TI-SmartView™ Emulator is active.
  - Teachers can use this feature to drag and paste an image to presentation tools such as SMART® Notebook, Promethean's Flipchart, and Microsoft® Office applications including Word and PowerPoint®.

## Accessing Screen Capture

The Screen Capture tool is available from all workspaces. To access Screen Capture:

- ▶ From the menu bar, click **Tools > Screen Capture**.
- ▶ From the toolbar, click  .

## Using Capture Class

In the classroom, use the Screen Capture tool to view and capture student screens. You can capture the screen of one selected student, of multiple selected students, or of all the students in the class.

If using TI-Nspire™ Navigator™ NC Teacher Software, you can select to view only the work area of the student software on the student screens, or the entire computer screen, which may include all applications the student as open at the time.

**Note:** To view and capture student screens, they must be logged into class.



## Capturing Student Screens

1. If you have not already done so, begin the class session and ask your students to log in.
2. Click  , and then click **Capture Class**.

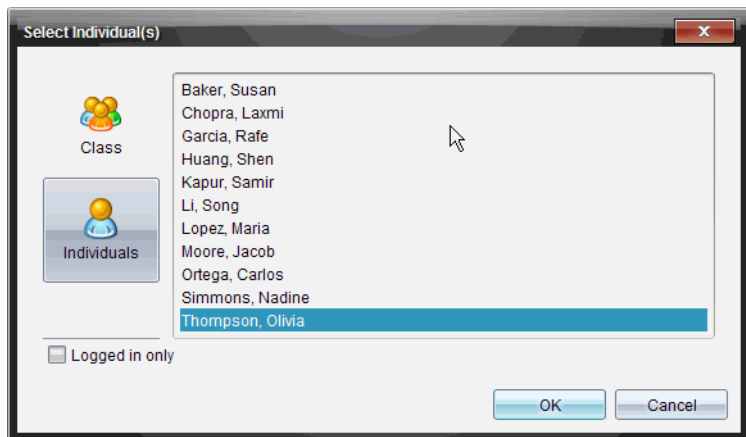
The Select Individual(s) dialog box opens. If you selected students in Class Workspace, those student names are highlighted. If no students were selected, all student names in the class are selected.



3. To change the selected student or add more students:

- Click  to display the screens of all students in the class. If a student is not logged in, the handheld display indicates "Not Logged In." As students log in, click refresh to update your screen.
- Click , and then click the name of each student to display the screens of individual students. To select multiple students, hold down the **Shift** key. To select students in random order, hold down the **Ctrl** key (Mac@: ⌘) and click each student name.
- Select the **Logged in only** check box under the left pane to display screens from only those students currently logged in. When you refresh your screen, any students who log in after the initial screen capture will be listed at the end of the Class Screen Capture window.

4. Click **OK**.

To view only the work area and not the entire student screen, select **Show TI-Nspire Work Area Only**.

The screens of the selected students are displayed in the Class Screen Capture window.

**Note:** The following example shows the screens from two selected students who are logged in. The default view is Tiled, which shows all screens captured in the window.

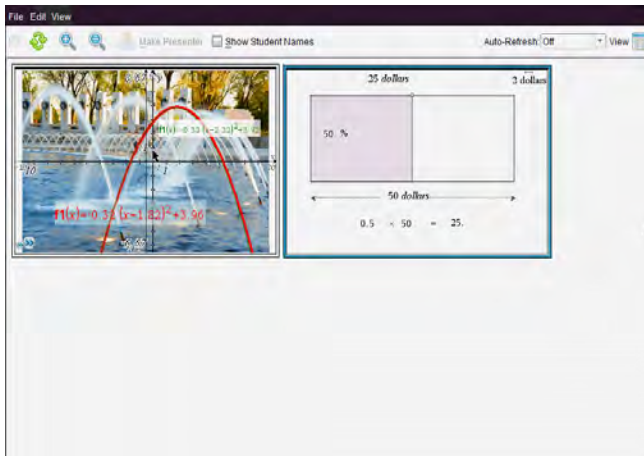

5. Decide if you want to display or hide the student names. To hide or show student names, select the check box on the toolbar to toggle between hide and show or click **View > Show Student Names**.

**Note:** Your selection to show or hide student names remains in effect until you change it. For example, if you select to hide student names, the student names will remain hidden when you close the Class Screen Capture window and return to the Class Workspace. If you select to hide student names in the Class Workspace, they will be hidden when the Class Screen Capture window opens.

## Setting Teacher Preferences for Capture Class

Use the Teacher Preferences option to set preferences for using the randomize screen option and for displaying the teacher handheld. Creating a user name and password enables teachers to log in to an active class. You can also select to individualize the view of your handheld screen when it is displayed. For more information, see the handheld guidebooks [oneducation.ti.com/guides](http://oneducation.ti.com/guides).

1. From the TI-Nspire™ Navigator™ Teacher Software window, click **File > Settings > Teacher Preferences**.

The Teacher Preferences dialog box opens.

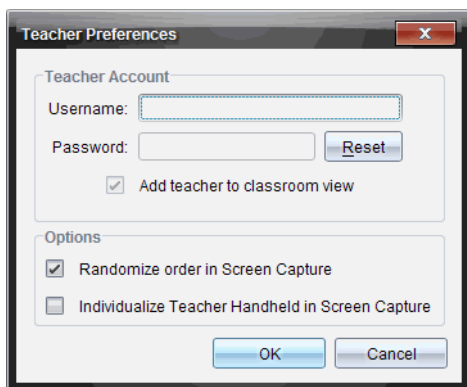

2. If you haven't already done so, create a Username and Password.
3. Select "*Add teacher to classroom view*" to show your handheld in the Class Screen Capture window.
4. To randomize the order in which screens are captured, select "*Randomize order in Screen Capture*."

5. Select the "*Individualize Teacher Handheld in Screen Capture*" option so that a captured screen from the teacher handheld appears differently in the Class Screen Capture window than screens captured from student handhelds.
6. Click **OK** to save the settings.

## **Setting View Options in Capture Class**

When working with captured screens in the Class Screen Capture window, you have several options for optimizing the view of the screens for presentation to a classroom, including:

- Toggling between a tiled view and a gallery view.
- Comparing selected screens in a side-by-side view.
- Refreshing the view as needed or setting the auto-refresh feature to automatically refresh the view at timed intervals.
- Zooming in or out to increase or decrease the size of the captured screens in the window. You can also select the percentage at which the size of the screen will be increased or decreased.
- Showing or hiding student names.
- Accessing Live Presenter options. For more information, see *Using Live Presenter*.

## **Toggling Between Tiled and Gallery Views**

When you capture student screens, the default view for the Class Screen Capture window is Tiled. Switch to Gallery view to show an enlarged view of a selected screen. Thumbnail views of all the captured screens are shown in the left pane, enabling you to find and select screens.

To toggle between Tiled and Gallery views:

- ▶ Click , and then click **Gallery** or **Tiled**.  
—or—
- ▶ Select **View > Gallery** or select **View > Tiled**.  
—or—
- ▶ For Gallery view, press Ctrl + G. (Mac®: ⌘ + G). For Tiled view, press Ctrl + T (Mac®: ⌘ + T).

In Gallery view, thumbnail images of captured screens are displayed in a column in the left pane of this view. An enlarged view of a selected screen is displayed in the right pane.

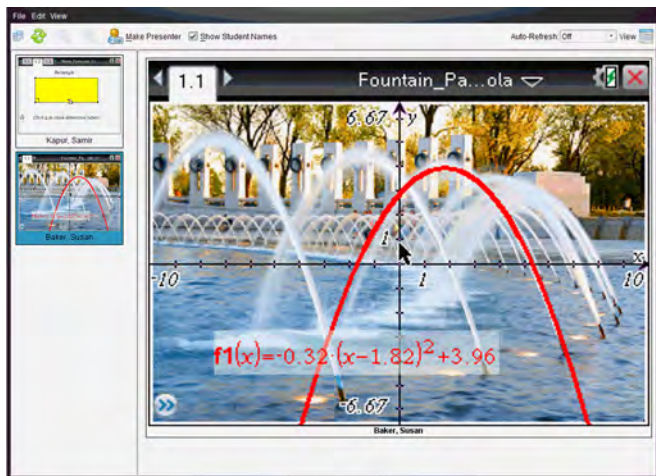

- Captured screens appear in the same order as in Tiled View.
- If you select multiple thumbnails to view in the left pane, they are displayed in the right pane.
- If you select more than four thumbnails, view the additional screens by scrolling down the right pane.
- If you selected to show student names, names are centered under each student's captured screen.
- Zoom functions are disabled in Gallery View.
- You can change the order of the screens in the Gallery View.
- The width of the thumbnail pane cannot be changed.

## Rearranging Captured Screens

Complete the following steps to change the order of the captured screens within the Class Screen Capture window.

1. Click the desired screen to select it.
2. Holding the left mouse button down, drag the screen to the desired location and release.

## Refreshing Captured Screens

As students log in to class and work on their screens, you can update the view of the captured screens. When you refresh the view in the Class Screen Capture window, the latest student screens are displayed. You can refresh the view as needed, or you can set the auto-refresh option to refresh the view automatically at timed intervals.

## Refreshing the View as Needed

- ▶ Click .

The latest screens from the connected handhelds are captured and displayed in the Class Screen Capture window.

**Note:** If a student has lost connection and a screen cannot be refreshed, it is outlined in yellow.

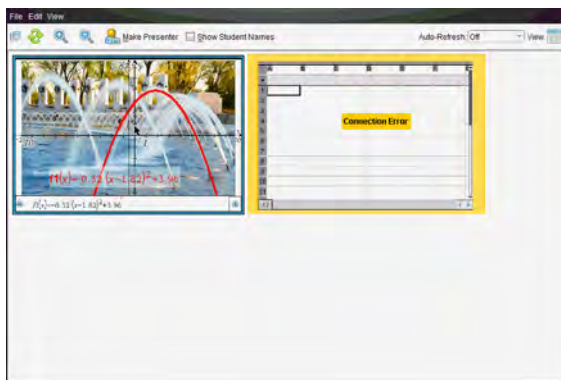

The border color changes if a screen cannot be refreshed.

## Enabling the Auto-Refresh Screen Capture Feature

The auto-refresh feature is useful for monitoring class performance. This feature enables you to automatically refresh the view of captured screens at timed intervals. The default setting for the auto-refresh feature is Off. To enable auto-refresh:

1. Click **View > Auto Refresh** or select **Auto-Refresh: Off** on the toolbar.

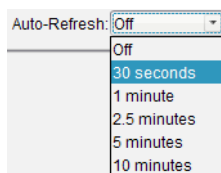



2. Click one of the available time interval options.

**Note:** Auto-refresh is available when using either the Tiled or Gallery view. It is not available in Live Presenter mode.

## Using Zoom in and Zoom out

In the Class Screen Capture window, use the zoom in and zoom out options to increase or decrease the size of the captured screens.

- ▶ From the toolbar, click  to increase the size of the screens in the view. You can also select **View > Zoom In** from the menu.
- ▶ From the toolbar, click  to decrease the size of the screens in the view. You can also select **View > Zoom Out** from the menu.

## Setting a Zoom Percentage

The Zoom Percentage option enables you to select the percentage by which the screen image is increased or decreased when zooming in or out. To select a percentage:

1. From the Class Screen Capture window, click **View > Zoom Percentage**.

The drop-down list of available percentages opens.

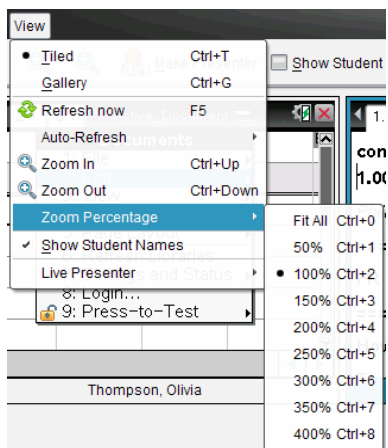

2. Click one of the available percentages.





## Creating Stacks of Student Screens

This feature enables you to collect a history of one or more students' screens captured in the Capture Class option. These collections are called stacks, and you can add or remove screens from each student's stack, as well as navigate within and through student stacks. Using stacks is a convenient way to check progress in a lesson, collect student presentations or assignments to review and grade later, or to show performance and progress in parent/teacher meetings.

You add, remove, navigate, and save stacks from the Class Capture window, which becomes available when you use the Capture Class option.

- ▶ To open the Class Capture window, click **Window > Class Capture Window**.

### Adding Screens to a Stack

- ▶ In the Class Capture window, click **View > Stacks > Add to Stack**, or click .
- ▶ To add another set of screens, first click **Refresh**  and then add the stack.

When the first set of screens is added to a new stack, it is labeled Frame1. Each subsequent addition increases the number by one; for example, Frame2, Frame3, and so forth.

### Removing Frames from a Stack

1. Select the frame you want to remove.
2. Click **View > Stacks > Remove from Stack**, or click .

As frames are removed from a stack, their names are adjusted to remain sequential and reflect the deletion. For example, if Frame6 is deleted, Frame7 is renamed to Frame6 and all subsequent frame numbers are adjusted downward by one digit.

### Navigating Through Stacks

You can navigate a stack of frames from either the tiled or gallery view.

- ▶ To view different frames in a stack, use one of these options:
  - Click the drop-down arrow, and then click the desired frame from the list.

- **View > Stacks > Next Frame**, or click .
- **View > Stacks > Previous Frame**, or click .

**Note:** These options are available only if there is a next or previous frame to view.

## Saving Stacks

When you close the Class Capture window, the software asks if you want to save the stacks.

1. Click **Yes** to save the stacks.

The Select or Create Folder to Save Stacks dialog box opens.

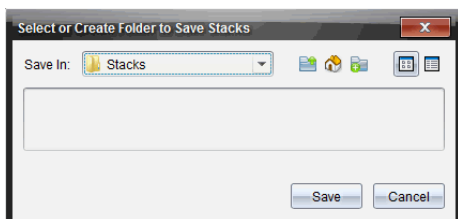

2. Click **Save** to save the stacks in the default folder, or create or navigate to another folder and then click **Save**.

The stacks are saved as individual screen captures with the student's name, image number, date, and time. For example:

Laxmi Chopra\_image1\_10-21-2011\_11-50

Laxmi Chopra\_image2\_10-21-2011\_11-57

Use the Content Workspace or your computer's file management system to locate and open the saved screens.

The screens open in the default photo viewer on your computer.

## Comparing Selected Screens

This feature enables you to compare student screens side-by-side.

1. Select the student screens you want to compare. To select multiple consecutive screens, hold down the **Shift** key. To select screens in random order, hold down the **Ctrl** key (Mac®: ⌘) and click each image you want to save. When you select each screen, the border changes color.

**Note:** If you select more than four screens, scroll down the viewing pane to see them.

2. Click **Edit > Compare Selected**.

If you are in Tiled view, the view switches to Gallery view and the selected screens are listed in the order selected.

**Note:** This option is disabled when in Gallery view.

3. To exit comparison mode, click outside the screen in the left pane of the Gallery view.

## **Using Make Presenter**

Select a captured screen from the Class Screen Capture window, and then click the **Make Presenter** option on the toolbar to launch Live Presenter and present a student screen to the class. You can only choose one student at a time to be the Live Presenter. For more information, see *Using Live Presenter*.

## **Saving Screens When Using Capture Class**

You can save captured screens for use in other TI-Nspire™ documents that allow images or for use in other application such as Microsoft® Word. You can save images in the following formats: .jpg, .png, or .gif. You can save one image at a time, select multiple images to save, or save all captured images.

### **Saving Screen Images**

To save screen images captured when using Capture Class, complete the following steps.

1. In the Class Screen Capture window, select the screen or screens you want to save as image files.
  - To select multiple consecutive screens, click the first image, and then hold down the **Shift** key and click the additional images. To select screens in random order, hold down the **Ctrl** key (Mac®: ⌘) and click each image you want to save.
  - To select all captured screens, click **Edit > Select All**.
2. Click **File > Save Selected Screen(s)** or press **Ctrl + S** (Mac®: ⌘ + S).

The Save dialog box opens.

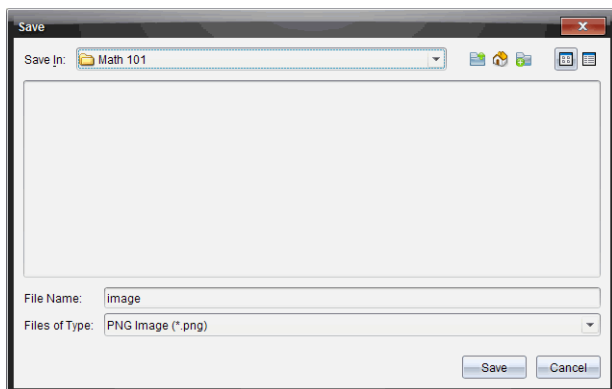

3. Navigate to the folder on your computer where you want to save the file(s).
4. Type a name for the file or files in the **File Name** field.
5. In the **Files of Type** field, click ▼, and then select the file type: .png, .jpg, or .gif. The default file type is .jpg.
6. Click **Save**.

The file or files are saved in the designated folder.

- If you saved one image, the file is saved with the name as specified in the **File Name** field.
- If you saved multiple images, the files are saved with the name specified in the **File Name** field with a number appended to the file name to make each file name unique. For example, *Image1*, *Image 2*, and so on.

## ***Printing Captured Screens***

You can print screens captured using the Capture Class option. You can print one, multiple, or all captured screens. For each printed page, the class name is printed in the page header, and the date and page number are printed in the page footer.

**Note:** The print option is not available when using the Capture Page or Capture Selected Handheld options.

To print a captured screen:

1. Select the screen you want to print.

2. Click **File > Print**.

The Print dialog box opens.

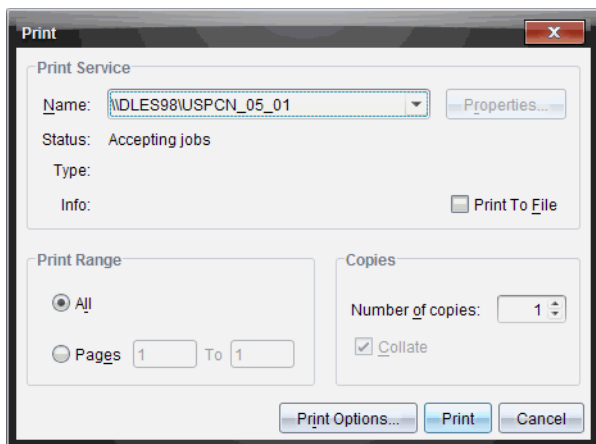

3. If you selected more than one screen, click **Print Options** to select the number of screen captures that you want per page.

The Print Options dialog box opens.

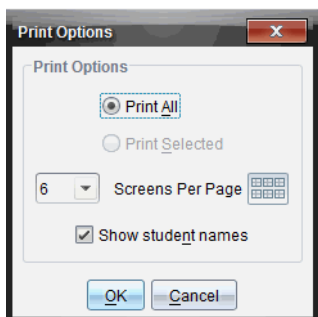

4. Select options as needed. You can select to print one screen per page, six screens per page, or all screens on the page. You can also select whether to print student names.
5. Click **OK** to return to the Print dialog box.
6. Select the individual printer options for your printer.
7. Select the number of copies you want to print.
8. Click **Print** to send the print job to the selected printer.

## Using Capture Page

Use the Capture Page option to capture an image of an active page in a TI-Nspire™ document. You can save images in the following file formats: .jpg, .gif, .png, and .tif. Saved images can be inserted into TI-Nspire™ applications that allow images. The image is also copied to the Clipboard and can be pasted into other applications such as Microsoft® Word or PowerPoint.

### Capturing a Page

Complete the following steps to capture an image of an active page.

1. In the Documents Workspace, open a document and navigate to the page you want to capture to make it active.
2. Click , and then click **Capture Page**.

The image of the active page is copied to the Clipboard and to the

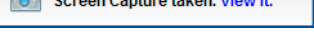
Screen Capture window. The  dialog box opens in the lower right corner of your desktop when the screen capture is complete.

3. Click **View it**.

The Screen Capture window opens.

You can also click **Window > Screen Capture Window** to open the Screen Capture window.

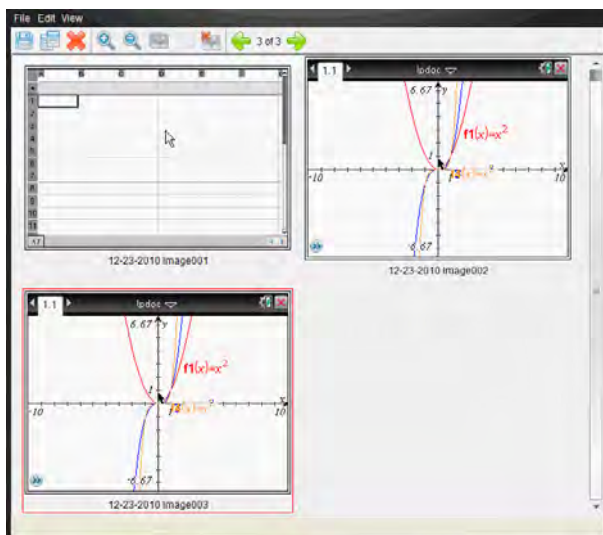

4. To capture additional pages, move to another page in the current document or open a new document to select a page.

As you capture additional pages, the images are copied to the Screen Capture window, which holds multiple images. The last page captured replaces the contents of the Clipboard.

## ***Using Capture Selected Handheld***

Use the Capture Selected Handheld option to capture the active screen on a connected handheld.

1. On a connected handheld, navigate to the menu or to a page in a document you want to capture.
2. In the software, select the connected handheld:
  - In the Content Workspace, select the handheld from the list of Connected Handhelds in the Resources pane.
  - In the Documents Workspace, open Content Explorer from the Documents Toolbox, and then select the handheld from the list of Connected Handhelds.
  - In the Class Workspace, select a logged in student.
3. Click , and then click **Capture Selected Handheld**.

—or—

Click , and then click **Capture Selected Handheld**.

The screen is copied to the Clipboard and to the TI-Nspire™ Screen

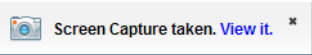
Capture window. The  dialog box opens in the lower right corner of your desktop when the screen capture is complete.

#### 4. Click **View it**.

The Screen Capture window opens.

You can capture additional screens from an open document on a connected handheld or open another document on a connected handheld to capture screens from that document.

As you capture additional screens, the images are copied to the Screen Capture window, which holds multiple images. The last screen captured replaces the contents of the Clipboard.

## Viewing Captured Screens

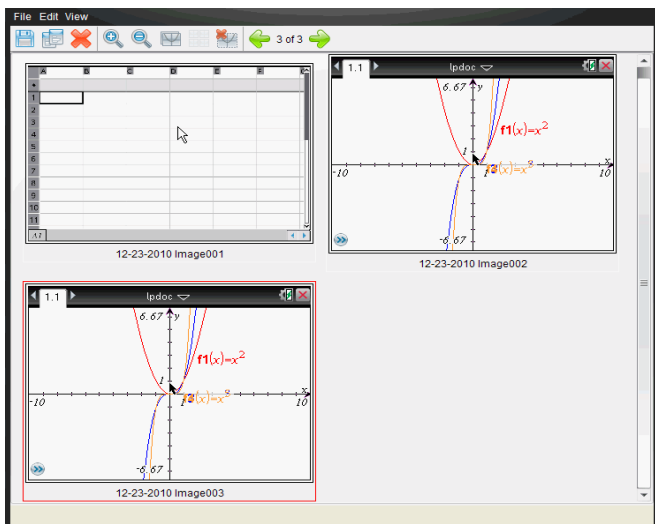

When you capture a page or screen, it is copied to the Screen Capture window.



## Zooming the View of Captured Screens

In the Screen Capture window, use the zoom in and zoom out options to increase or decrease the size of the captured screens.



- ▶ From the toolbar, click  to increase the size of the screens in the view. You can also click **View > Zoom In** from the menu.
- ▶ From the toolbar, click  to decrease the size of the screens in the view. You can also click **View > Zoom Out** from the menu.

## Saving Captured Pages and Screens

You can save captured pages and screens captured as images for use in other TI-Nspire™ documents that allow images or for use in other applications such as Microsoft® Word. You can save one image at a time, select multiple images to save, or save all captured images.

### Saving Selected Screens

1. In the Screen Capture window, select the screen image you want to save.
2. Click **File > Save Selected Screen(s)**.

**Note:** From the Screen Capture window, you can also click  .  
The Save as dialog box opens.

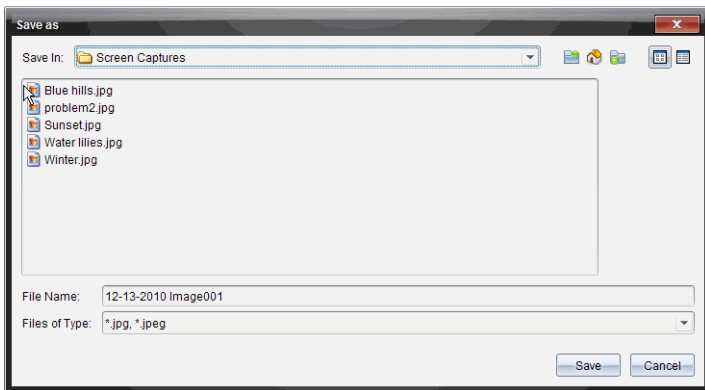

3. Navigate to the folder on your computer where you want to save the file.
4. Type a name for the file.  
**Note:** The default file name is *MM-DD-YYYY Image ###*.
5. Select the file type for the image file. The default format is .jpg. Click ▼ to select another format: .gif, .tif, or .png.

6. Click **Save**.

The file is saved in the designated folder.

## **Saving Multiple Screens**

1. In the Screen Capture window, select the screens you want to save.

To select multiple consecutive screens, click the first image, and then hold down the **Shift** key and click the additional images. To select screens in random order, press **Ctrl** (Mac®: ⌘) and click each image you want to save.

2. Click  or select **File > Save Selected Screen(s)**. To save all captured screens, select **File > Save All Screens**.

**Note:** The "Save All Screens" option is not available when using Capture Class.

The Save as dialog box opens.

3. In the Save In field, navigate to the folder where you want to save the images.
4. In the File Name field, type a new folder name. The default folder name is *MM-DD-YYYY Image*, where *MM-DD-YYYY* is the current date.
5. Select the file type for the image files. The default format is .jpg. Click ▼ to select another format: .gif, .tif, or .png.
6. Click **Save**.

The images are saved in the specified folder with system-assigned names reflecting the current date and a sequence number. For example, *MM-DD-YYYY Image 001.jpg*, *MM-DD-YYYY Image 002.jpg* and so on.

## **Copying and Pasting a Screen**

You can select a captured screen and copy it to the Clipboard for inclusion into other documents or applications. You can also print copied screens. Copied screens are captured at 100% zoom level, and they are copied in the order of selection.

### **Copying a Screen**

1. Select the screen to copy.

2. Click  or **Edit > Copy**.

The selected screen is copied to the Clipboard.

## Pasting a Screen

Depending on the application you are pasting to, click **Edit > Paste**.

**Note:** You can also drag a screen capture to another application. This functions as a copy and paste.

## Capturing Images in Handheld Mode

In the Documents Workspace, use the DragScreen feature to capture the emulator screen or side screen when the TI-SmartView™ Emulator is active.

Teachers can use this feature to drag and paste an image to presentation tools such as SMART® Notebook, Promethean's Flipchart, and Microsoft® Office applications including Word and PowerPoint®.

## Capturing Images Using the DragScreen Feature

Complete the following steps to capture an image and copy it to a third-party application.

1. From the Documents Workspace, click , which is located in the Documents Toolbox.

The TI-SmartView™ Emulator opens.

- If the display selected is **Handheld + SideScreen**, the current document is shown in the emulator and in the side screen.
- If the display selected is **Keypad + SideScreen**, the current document is shown in the side screen.

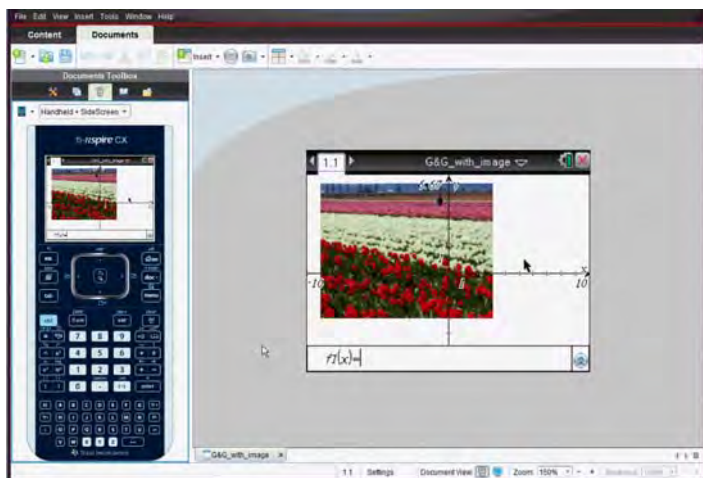

- To start the screen capture, click the area above the emulator screen or above the keypad. In the **Handheld + SideScreen** display, you can also click the area around the emulator screen.

Do not release the mouse button. If the cursor is active or if you click inside the emulator window, the screen capture is not started.

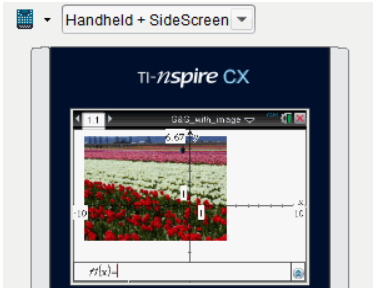

In Handheld + SideScreen view, click the area above the emulator, click the area around the emulator, or click the border of the emulator screen to start the screen capture.



In Keypad + SideScreen view, click the area above the keypad to start the screen capture.

- Without releasing the mouse, drag the image.

A ghost image of the captured screen opens. The ghost image remains visible until you release the mouse button.



The  in the corner of the ghost image indicates you cannot paste the image in that location.

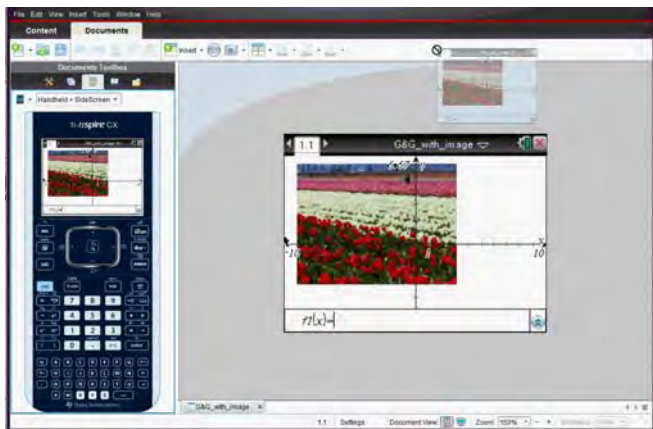

ghost  
image

4. Drag the image to an open third-party application. When the image is on top of the third-party application, the  indicates you can drop the image.
5. Release the mouse button to drop the image into the selected application.

The image is also copied to the Clipboard and to the TI-Nspire™ Screen Capture window.

To view captured images in the Screen Capture window, click **Window > Screen Capture Window**.

You can capture additional screens as needed. As you capture additional screens, the images are copied to the Screen Capture window, which holds multiple images. The last screen captured replaces the contents of the Clipboard.



## Using Live Presenter

In the TI-Nspire™ Navigator™ Teacher Software, Live Presenter enables teachers to project and present actions on a selected handheld in real-time. Teachers can choose to project their own handheld screen or any student's handheld screen to show work as it is being performed and discuss the step-by-step process with the class. During the live presentation, you can show the TI-Nspire™ handheld being displayed and show the keys as they are pressed by the presenter.

Teachers can also control what appears on the presentation screen: student's name, handheld display, or keypress history. Teachers can also record the Live Presenter session and save the file as a movie for later use.

While Live Presenter is active, all other student handhelds are unaffected by the presentation and can be used.

### ***Before Starting Live Presenter***

Live Presenter is accessible from the Class Workspace. To use Live Presenter:

- Ensure student handhelds are connected.
- Begin a class.
- Ensure students are logged in.

### ***Starting Live Presenter***



Make sure the student selected to be the presenter is logged into an active class session. Although only one person can present at a time, you can select anyone to present as long as they are logged in and the class session is active.

- ▶ From the Class Workspace, select a student in the class, and then click **Tools > Live Presenter**.
- ▶ To present the teacher handheld, ensure you are logged in, and then click **Tools > Live Presenter**.

**Note:** If you have not set teacher preferences, go to **File > Teacher Preferences**. For more information, see the handheld guidebooks on [education.ti.com/guides](http://education.ti.com/guides).

### **Starting Live Presenter from Class Screen Capture Window**

You can also start Live Presenter from the Class Screen Capture window:

1. From the Class Workspace, click  , and then click **Capture Class**.  
The Select Individual(s) dialog box opens.
2. Check Logged in only to display all students currently logged in.  
**Note:** If you selected a logged in student in the Class Workspace, that student's name is highlighted in the Select Individual(s) dialog box. To select all students in the class, click  .
3. Click **OK**.  
The Class Screen Capture dialog box opens.
4. Select a student who is logged in, and then click  .  
The Class Screen Capture window opens in Live Presenter mode. By default, the window opens in full-screen view. Use the minimize and maximize buttons in the upper right corner to adjust the size of the window.



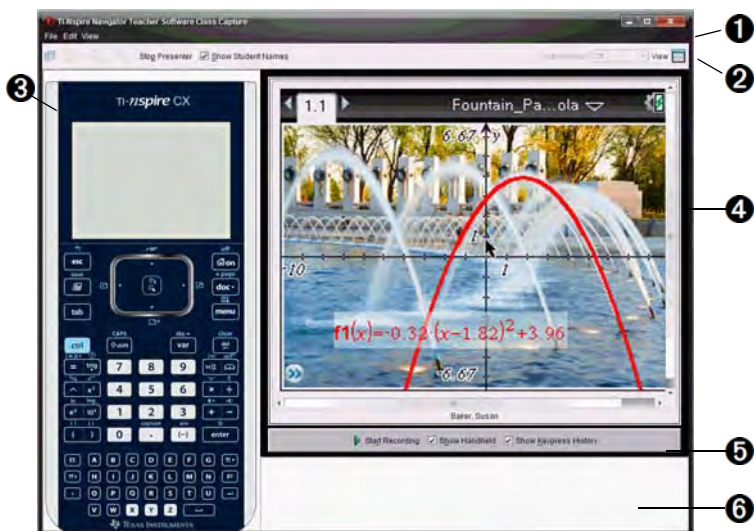

**1 Menu bar.** Only options applicable to Live Presenter are available from the File menu and the View menu:

- Click **File > Close** to close Live Presenter.
- Click **Edit > Copy** to copy the keys in the Keypress History pane.

—or—

Press **Ctrl + C**.

Mac®: **⌘ + C**

- Click **View > Show Student Names** to hide student names if they are showing or show student names if they are hidden.
- Click **View > Live Presenter** to access options for working with Live Presenter.

**Note:** Other menu options are enabled when viewing captured screens.

**2 Toolbar.** Only tools applicable to Live Presenter are selectable. In Live Presenter you can:



- Click **Stop Presenter** to stop Live Presenter.
- Select  **Show Student Names** to show student names or clear to hide student names.

- ③ **Handheld pane.** Displays the presenter's handheld type. As the presenter presses keys on their handheld, the keys in the display turn red so viewers can follow along. The last key pressed remains highlighted until a different key is pressed.

**Note:** In Live Presenter, the handheld pane does not function like the TI-SmartView™ emulator. You cannot use a mouse to click or press keys—the presenter must press the keys on their handheld.

- ④ **Display pane.** Displays the presenter's handheld screen. If you selected to show the student name, the name is shown under the screen.

⑤ **View options:**

- Click  to record the session. Click  to stop the recording.
- Select  Show Handheld to show the handheld pane. Clear to hide the handheld pane. When you hide the handheld, the Keypress History is shown in this pane.
- Select  Show Keypress History to show the Keypress History pane. Clear to hide the Keypress History pane.

**Note:** To view only the handheld screen, clear  Show Handheld and  Show Keypress History.

- ⑥ **Keypress History pane.** As the presenter presses keys on their handheld, the keypress sequence is shown left to right.

**Note:** If the handheld is hidden, the keys pressed are shown in the left pane and this pane closes.

## ***Hiding and Showing Student Names***

If showing, the student name is shown under the handheld screen in Live Presenter.

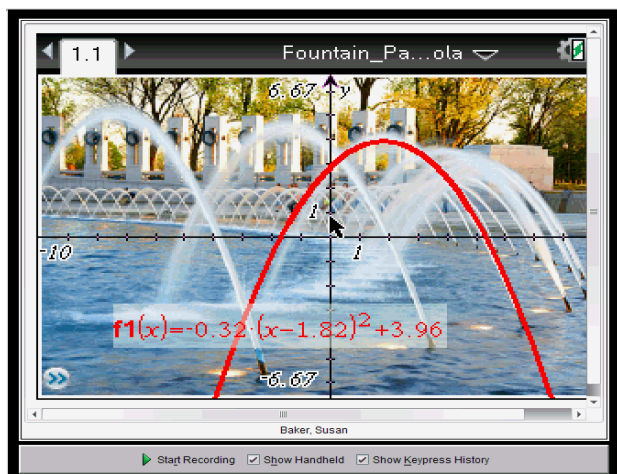

student name is shown here

The student name is shown in the same format selected in Capture Class. If you select to show or hide student names in Capture Class, the student name will be shown or hidden when you start Live Presenter.

To hide the student name in Live Presenter:

- ▶ Clear  Show Student Names

The student name is hidden.

## ***Hiding and Showing the Presenter Handheld***

By default, the handheld is shown when you start Live Presenter. Showing the handheld enables the class to see which keys are pressed during the presentation. When the handheld is shown:

- The key turns red in the display so that the class can follow along when the presenter presses a key.
- The last key pressed remains highlighted until a different key is pressed.
- The keys on the handheld display cannot be pressed or clicked. This visual display only shows what the presenter presses on their handheld.

### **Hiding the Handheld Display**

- ▶ To hide the handheld, clear **Show Handheld** in the View Options bar.

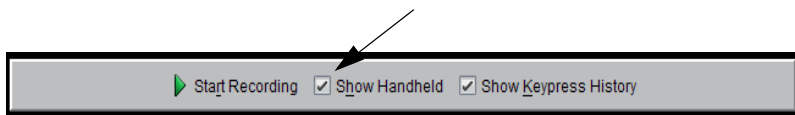

The handheld is hidden and the Keypress History is shown in the left pane.

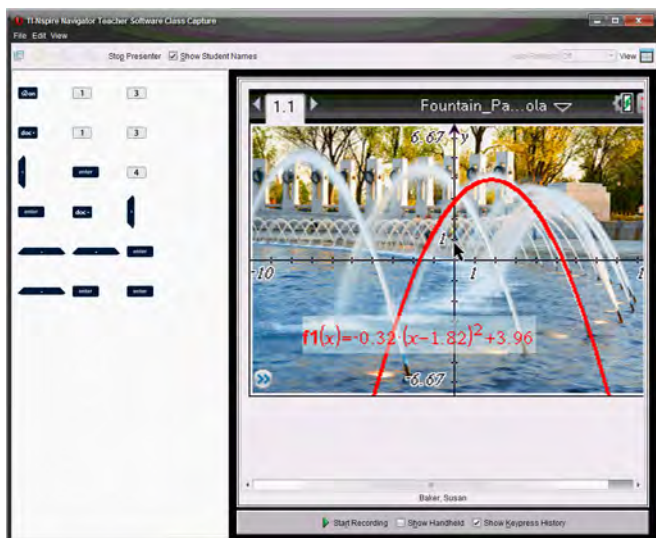

## Showing the Handheld

- ▶ If the handheld is hidden, click **Show Handheld** to show the presenter's handheld in the left pane.

The handheld is displayed in the left pane and the Keypress History pane opens under the handheld screen if selected.

## Viewing Keypress History

By default, the Keypress History pane is open under the handheld screen when you start Live Presenter.

- As keys are pressed during the live presentation, they appear in the Keypress History pane.
- As keys are pressed, they are displayed from left-to-right, and then top-to-bottom.
- If the presenter presses the same key more than once, each repeated key press is shown in the Keypress History pane. If the presenter

presses and holds one key (as when moving the cursor), the key is recorded only one time.

- You can copy the keys captured in the Keypress History pane to the Clipboard, and then paste the images into another document. You can also clear the Keypress History pane. (Students are not able to do this.)
- During lengthy live presentation sessions, the keys pressed may expand beyond the display area. When this happens, a scroll bar appears so you can review all keys pressed during the session.

## Hiding Keypress History

- ▶ To hide the Keypress History pane, clear Show Keypress History.

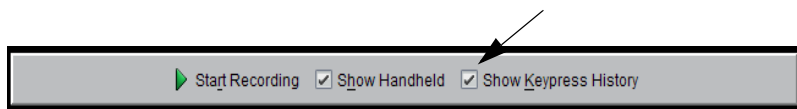

The Keypress History pane closes.

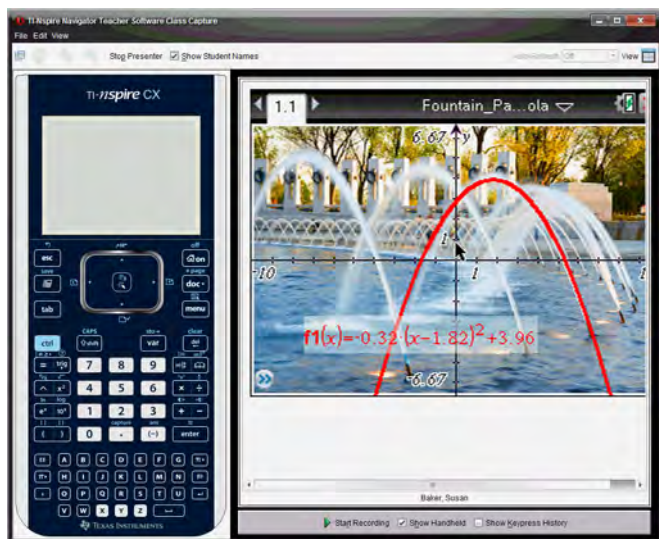

## Showing Keypress History

- ▶ If the Keypress History pane is hidden, check **Show Keypress History**.
  - If the handheld is shown, the Keypress History pane opens below the presenter's handheld screen.

- If the handheld is hidden, the Keypress History is displayed in the pane to the left of the presenter's handheld screen.

## **Copying Keypress History**

You can copy the keys captured in the Keypress History pane to the Clipboard then paste the images of the keys into a Microsoft® Word document or PowerPoint presentation.

1. In the Keypress History pane, select the keys you want to copy.
2. Click **Edit > Copy**.

—or—

Press **Ctrl + C**.

Mac®: **⌘ + C**

Images of the keys are copied to the Clipboard.

## **Clearing Keypress History**

To clear the Keypress History pane:

- ▶ Click **View > Live Presenter > Clear Keypress History**.

The keys displayed in the Keypress History pane are removed.

## **Showing the Handheld Screen Only**

To show only the presenter's handheld screen during the Live Presenter session:

- ▶ Clear the **Show Handheld** and the **Show Keypress History** options.

The Handheld and Keypress History panes close and the handheld screen is displayed in the window.

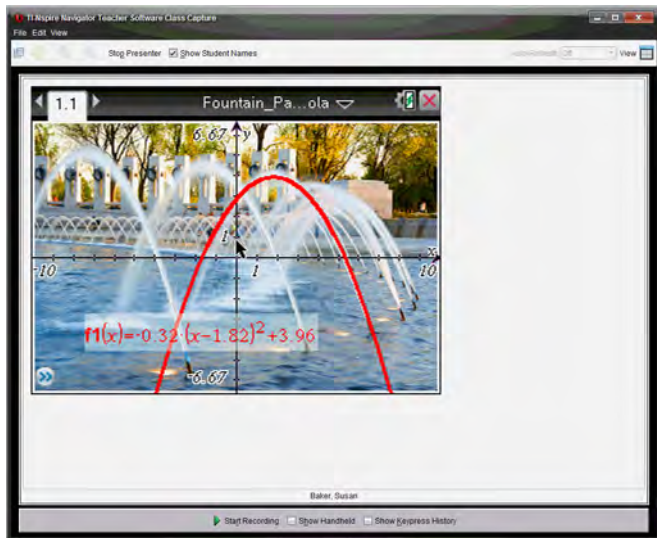

## Recording the Live Presentation

You can record and save the live presentation as a movie (.avi file). Movies are a useful way to present demonstrations to a class, provide additional tutoring for difficult concepts, or provide a way for students who missed the class to review the lesson. When you record the presentation, only the handheld screen is captured. The handheld display and the keys pressed are not recorded. When you save a recorded presentation, the file is saved with the Audio Video Interleave (.avi) file extension.

### Starting the Recording

- ▶ Click .

—or—

Click **View > Live Presenter > Start Recording**.

Recording begins. When clicked, the button changes to **Stop Recording**. All of the presenter's work on the handheld screen is recorded until you stop the recording.

### Stopping and Saving the Recording

Complete the following steps to stop the recording and save the movie file.

1. Click .

—or—

Click **View > Live Presenter > Stop Recording**.

The Save dialog box opens. The default name for the movie is “presentation” and the default save location is the class folder for the class that is active. You can change both the file name and the storage location.

**Note:** If you don’t want to save the recording, click **Cancel**.

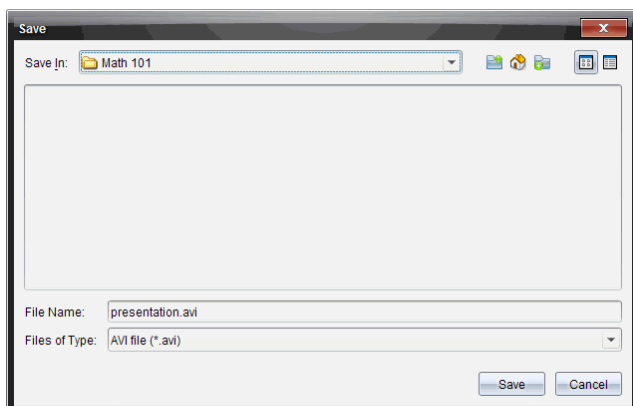

2. Navigate to the folder where you want to save the .avi file if different from the default folder.
3. Type a new name for the file.
4. Click **Save**.

The file is saved in the designated folder.

## Playing and Sharing the Recording

Once the recording is saved as an .avi file, you can play it on your computer. You can also send the file to others as an email attachment.

To play the recording on your computer:

1. Using your file browser, navigate to the folder where you saved the presentation (.avi) file.
2. Double-click the .avi file name.

Your default media player opens and the movie plays.

**Note:** If the .avi file format is not compatible with your default player, an error message is displayed.

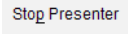

## Stopping Live Presenter

- ▶ To stop Live Presenter, click  .  
—or—

Click **View > Live Presenter > Stop Presenter**.

The presentation window closes and the Class Workspace is displayed. The class is still active. When you are ready to end the class, click

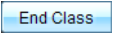
 .



# Using the Documents Workspace

Use this workspace to create, modify, and view TI-Nspire™ and PublishView™ documents, and to demonstrate mathematical concepts.

## Exploring the Documents Workspace

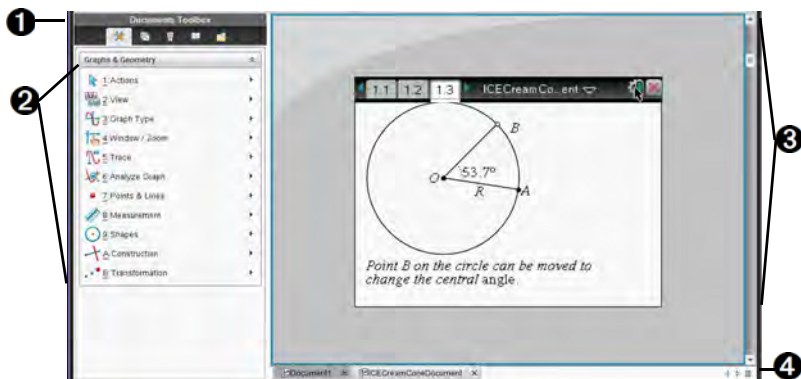

**1 Documents Toolbox.** Contains tools such as the Document Tools menu, Page Sorter, Content Explorer, Utilities, and TI-SmartView™ emulator. Click each icon to access the available tools. When you are working in a TI-Nspire™ document, the tools available are specific to that document. When you are working in a PublishView™ document, the tools are specific to that document type.

**2 Toolbox pane.** Options for the selected tool are displayed in this area. For example, click the Document Tools icon to access tools needed to work with the active application.

**Note:** In the TI-Nspire™ Teacher Software, the tool for configuring questions opens in this space when you insert a question. For more information, see *Using Question in the TI-Nspire™ Teacher Software*.

**3 Work area.** Shows the current document and enables you to perform calculations, add applications, and add pages and problems. Only one document at a time is active (selected). Multiple documents appear as tabs.

**4 Document information.** Shows the names of all open documents. When there too many open documents to list, click the forward and backward arrows to scroll through the open documents.

## Using the Documents Toolbox

The Documents Toolbox, located on the left side of the workspace, contains tools needed for working with both TI-Nspire™ documents and PublishView™ documents. When you click a toolbox icon, the associated tools appear in the Toolbox pane.

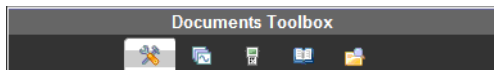

## Exploring Document Tools

In the following example, the Document Tools menu is open showing the options for the Calculator application. In TI-Nspire™ documents, the Document Tools menu contains tools available for working with an application. The tools are specific to the active application.

In PublishView™ documents, the Document Tools menu contains tools needed to insert TI-Nspire™ applications and TI-Nspire™ documents, as well as multimedia objects such as text boxes, images, and links to websites and files. For more information, see *Working with PublishView™ Documents*.

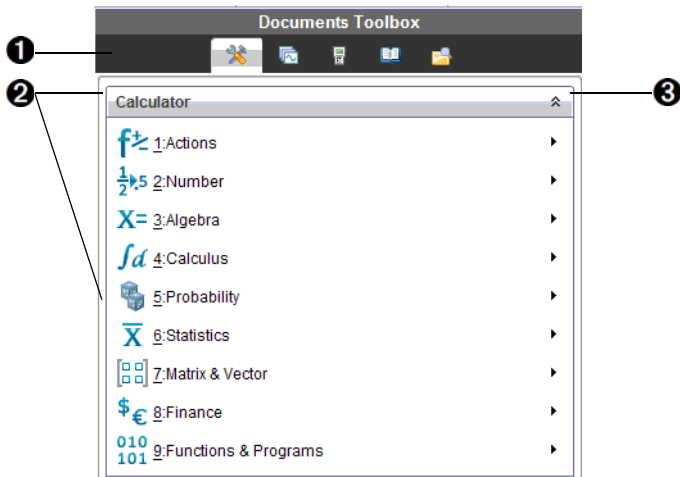

- 1 The Documents Toolbox menu.
- 2 Tools available for the Calculator application. Click ► to open the submenu for each option.

- Click  to close and click  to open Document Tools.

## Exploring the Page Sorter

The following example shows the Documents Toolbox with the Page Sorter open. Use the Page Sorter to:

- See the number of problems in your document and where you are.
- Move from one page to another by clicking on the page you want.
- Add, cut, copy, and paste pages and problems within the same document or between documents.

**Note:** When working in a PublishView™ document, the Page Sorter is not available in the Documents Toolbox.

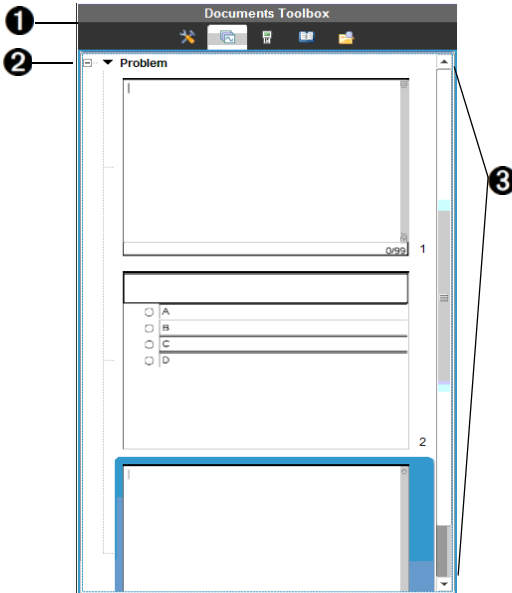

- 1 The Documents Toolbox menu.
- 2 Click the minus sign to collapse the view. Click the + sign to open the view and show pages in the document.
- 3 Scroll bar. The scroll bar is only active when there are too many pages to show in the pane.

## Exploring the TI-SmartView™ Feature

The TI-SmartView™ feature emulates how a handheld works. In the teacher software, the emulated handheld facilitates classroom presentations. In the student software, the emulated keypad gives students the ability to drive the software as if using a handheld.

**Note:** Content is displayed on the TI-SmartView™ small screen only when the document is in Handheld view.

When working in a PublishView™ document, TI-SmartView™ emulator is not available.

**Note:** The following illustration shows the TI-SmartView™ panel in the teacher software. In the Student Software, only the keypad is shown. For more information, see Using the TI-SmartView™ Emulator.

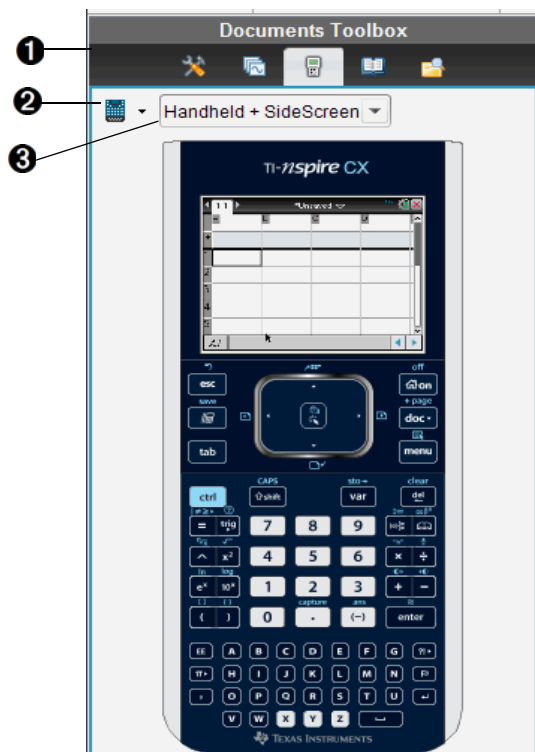

- ❶ The Documents Toolbox menu.
- ❷ Handheld Selector. Click ▼ to select which handheld to show in the pane:
  - TI-Nspire™ CX
  - TI-Nspire™ Touchpad
  - TI-Nspire™ ClickpadThen, select how to show the handheld:
  - Normal
  - High contrast
  - Outline
- ❸ View selector. In the teacher software, click ▼ to select the handheld view:
  - Handheld only
  - Keypad plus side screen
  - Handheld plus sidescreen

**Note:** You can also change these options in the TI-SmartView™ Options window. Click **File > Settings > TI-Smartview™ Options** to open the window.

**Note:** The view selector is not available in the student software.

When the Handheld Only display is active, select **Always in Front** to keep the display in front of all other open applications. (Teacher software only.)

## ***Exploring Content Explorer***

Use Content Explorer to:

- See a list of files on your computer.
- Create and manage lesson bundles.
- If using software that supports connected handhelds, you can:
  - See a list of files on any connected handheld.
  - Update the OS on connected handhelds.
  - Transfer files between a computer and connected handhelds.

**Note:** If you are using TI-Nspire™ software that does not support connected handhelds, the Connected Handheld heading is not shown in the Content Explorer pane.

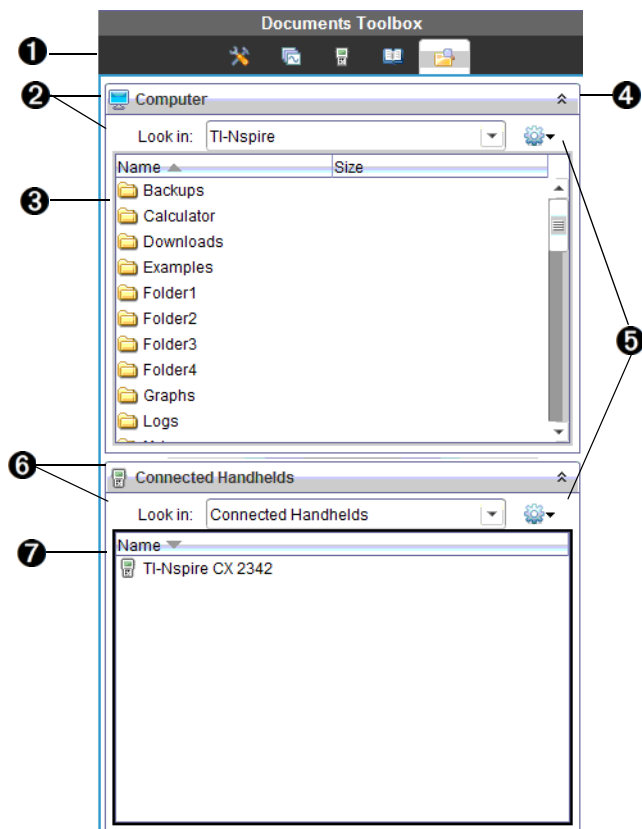

- 1 The Documents Toolbox menu.
- 2 Shows files on your computer and the name of the folder where the files are located. Click ▼ to navigate to another folder on the computer.
- 3 The list of folders and files within the folder named in the **Look In:** field. Right-click on a highlighted file or folder to open the context menu listing available actions for that file or folder.
- 4 Click ⤴ to close the list of files. Click ⤵ to open the list of files.



- 5  Options menu. Click ▼ to open the menu of actions you can perform on a selected file:
- Open an existing file or folder.
  - Move (navigate) up one level in the folder hierarchy.
  - Create a new folder.
  - Create a new lesson bundle.
  - Rename a file or folder.
  - Copy selected file or folder.
  - Paste file or folder copied to Clipboard.
  - Delete selected file or folder.
  - Select all files in a folder.
  - Package lesson bundles.
  - Refresh the view.
  - Install OS.
- 6 Connected handhelds. Lists the connected handhelds. Multiple handhelds are listed if more than one handheld is connected to the computer or when using the TI-Nspire™ Docking Stations.
- 7 The name of the connected handheld. To show the folders and files on a handheld, double-click the name.
- Click ▼ to navigate to another folder on the handheld.

## ***Exploring Utilities***

Utilities provides access to the math templates and operators, special symbols, catalog items, and libraries that you need when working with documents. In the following example, the Math templates tab is open.

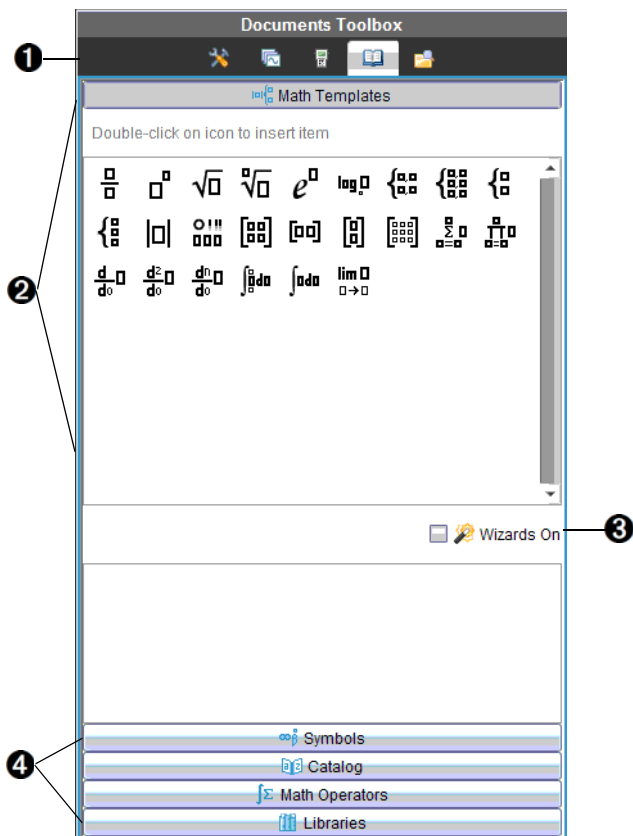

- 1 The Documents Toolbox menu.
- 2 Math Templates are open. Double-click a template to add it to a document. Click the Math Template tab to close the template view. To open the Symbols, Catalog, Math Operators, and Libraries, click the tab.
- 3 Wizards On check box. Select this option to use a wizard to enter function arguments.
- 4 Tabs for opening views where you can select and add symbols, catalog items, math operators, and library items to a document. Click the tab to open the view.

## Using the Work Area

The space on the right side of the workspace provides an area for creating and working with TI-Nspire™ and PublishView™ documents. This work area provides a view of the document so that you can add pages, add applications, and perform all work. Only one document at a time is active.

You can view documents in one of two views: computer mode or handheld mode. Either view will remember the last size and file location you used.

- **Handheld mode.** View documents as they appear on the handheld screen. The screen size is limited as it would be on the handheld.
- **Computer mode.** This is the default view in the software.

For more information about working with documents, see *Working with TI-Nspire™ Documents*.

## Changing Document Settings

Document settings control how all numbers, including elements or matrices and lists, are displayed in TI-Nspire™ and PublishView™ documents. You can change the default settings at anytime and you can specify settings for a specific document.

### Changing Document Settings

Complete the following steps to customize the settings that are applied to your document.

1. Create a new document or open an existing document.
2. From the status bar, double-click **Settings**.

—or—

Click **File > Settings > Document Settings**.

The Document Settings dialog box opens.

When you open Document Settings the first time, the default settings are displayed.

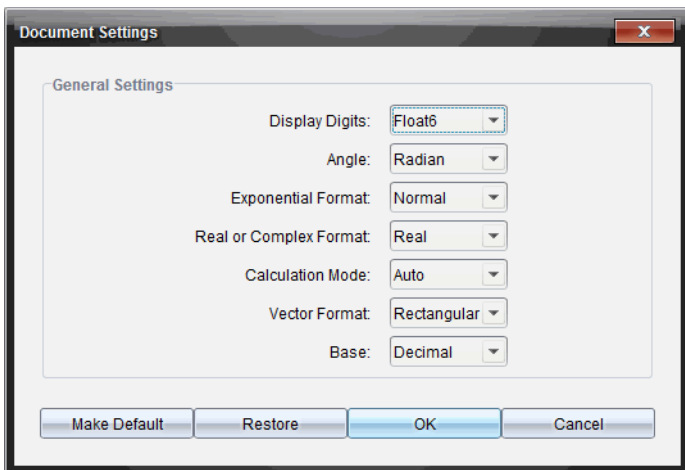

3. Press **Tab** or use your mouse to move through the list of settings. Click ▼ to open the drop-down list to view the available values for each setting.

Field	Value
Display Digits	<ul style="list-style-type: none"> <li>• Float</li> <li>• Float1 - Float12</li> <li>• Fix0 - Fix12</li> </ul>
Angle	<ul style="list-style-type: none"> <li>• Radian</li> <li>• Degree</li> <li>• Gradian</li> </ul>
Exponential Format	<ul style="list-style-type: none"> <li>• Normal</li> <li>• Scientific</li> <li>• Engineering</li> </ul>
Real or Complex Format	<ul style="list-style-type: none"> <li>• Real</li> <li>• Rectangular</li> <li>• Polar</li> </ul>

Field	Value
Calculation Mode	<ul style="list-style-type: none"> <li>• Auto</li> <li>• CAS: Exact</li> <li>• Approximate</li> </ul> <p><b>Note:</b> Auto mode shows an answer that is not a whole number as a fraction except when a decimal is used in the problem. Exact mode (CAS) shows an answer that is not a whole number as a fraction or in symbolic form, except when a decimal is used in the problem.</p>
Vector Format	<ul style="list-style-type: none"> <li>• Rectangular</li> <li>• Cylindrical</li> <li>• Spherical</li> </ul>
Base	<ul style="list-style-type: none"> <li>• Decimal</li> <li>• Hex</li> <li>• Binary</li> </ul>
Unit System (CAS)	<ul style="list-style-type: none"> <li>• SI</li> <li>• Eng/U.S.</li> </ul>

4. Click the desired setting.
5. Choose one of the following options:
  - To apply the customized settings to ALL documents, click **Make Default**.
  - To apply the settings to the open document only, click **OK**.
  - To restore default settings, click **Restore**.
  - Click **Cancel** to close the dialog box without making changes.

## Changing Graphs & Geometry Settings

Graphs & Geometry settings control how information is displayed in open problems and in subsequent new problems. When you change the Graphs & Geometry settings, the selections become the default settings for all work in these applications.

Complete the following steps to customize the application settings for graphs and geometry.

1. Create a new graphs and geometry document or open an existing document.

- In the Documents Toolbox, click  to open the Graphs & Geometry application menu.
- Click **Settings > Settings**.

The Graphs & Geometry Settings dialog box opens.

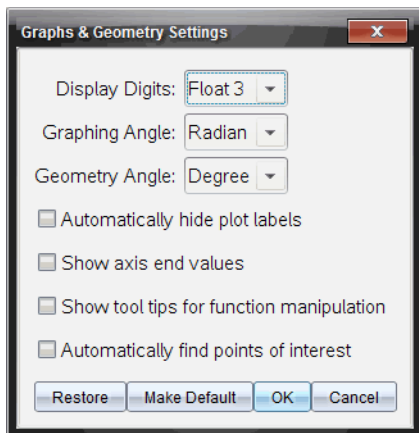

- Press **Tab** or use your mouse to move through the list of settings. Click  to open the drop-down list to view the available values for each setting.

Field	Values
Display Digits	<ul style="list-style-type: none"> <li>• Auto</li> <li>• Float</li> <li>• Float1 - Float12</li> <li>• Fix0 - Fix12</li> </ul>
Graphing Angle	<ul style="list-style-type: none"> <li>• Auto</li> <li>• Radian</li> <li>• Degree</li> <li>• Gradian</li> </ul>
Geometry Angle	<ul style="list-style-type: none"> <li>• Auto</li> <li>• Radian</li> <li>• Degree</li> <li>• Gradian</li> </ul>

5. Select the desired setting.
6. Select a check box to enable an option or clear a check box to disable an option.

<b>Check box</b>	<b>Operation when selected</b>
Automatically hide plot labels	Plot labels are displayed only when selected, grabbed, or hovered.
Show axis end values	A numeric label is displayed at the least and greatest values visible on an axis
Show tool tips for function manipulation	Shows helpful information as you manipulate function graphs
Automatically find a point of interest	Shows zeros, minima, and maxima for graphed functions and objects while tracing function graphs.

7. Choose one of the following options:
  - To apply the customized settings to ALL graphs and geometry documents, click **Make Default**.
  - To apply the settings to the open document only, click **OK**.
  - To restore default settings, click **Restore**.
  - Click **Cancel** to close the dialog box without making changes.





# Using Question in the Teacher Software

The Question application in the Teacher Software allows you to author multiple choice, open response, equation, expression, coordinate points, lists, image, and chemistry questions.

Although students cannot author questions, they can open documents containing questions, answer these questions, and, in Self-Check mode, check their work.

The Question application is located on the Insert menu in the Documents Workspace.

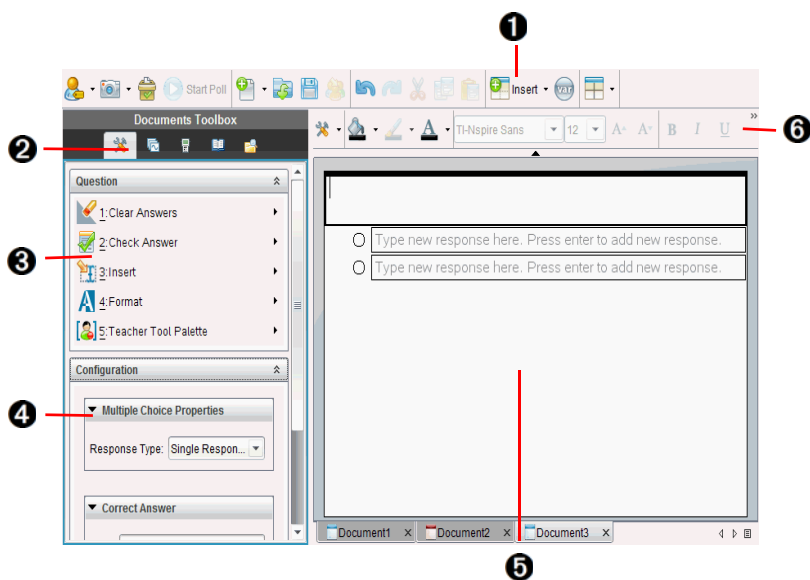





- 1 Insert menu.** Click **Insert** and select **Question** to add a question, or select **Image** to add an image to a question.
- 2 Document Tools.** Click this icon to open the toolbox pane.
- 3 Question tool.** Provides a menu of tools available for working with the Question application.
- 4 Configuration tool.** Allows you to set certain properties for each question you insert.
- 5 Question area.** This is where you type questions and view student responses.

**6 Formatting toolbar.** Allows you to apply formatting to text.

## Understanding the Question Tools



When you add a question, the Question application opens. If necessary, click Document Tools  to open the tools menu.

**Note:** The Teacher Tool Palette is not available to students.

Tool name	Tool function
 Clear Answers	Lets teachers or students clear the answers in the current question or in the document.
 Check Answer	If you select Self-Check as the document type in the Question Properties dialog box, students can check their answer to the question.
 Insert	Lets teachers or students insert an expression box or chemical equation box into the question or answer.
 Format	Lets teachers or students format the selected text as subscript or superscript. (The chemical equation box uses its own formatting tool, so this Format tool does not work in the chemical equation box.)
 Teacher Tool Palette	Lets you add copyright information and set the document type as Self-Check or Exam.

## Using the Insert Menu

The Insert menu in the Document Tools lets you add math expression

boxes  and chemical equation boxes  to the Question area, Suggested Response area, or Correct Answer area of some question types. When you are in question types that allow math expressions or chemical equations, place your cursor where you want to insert the box, and then follow these steps.

1. Open the Question tool.
2. Click **Insert > Expression Box** or **Chem Box**.

The software inserts a blank box where your cursor is positioned.

3. Type the desired math expression or chemical equation, and then click outside of the box to continue typing text.

## Using the Teacher Tool Palette

The Teacher Tool Palette allows you to add copyright information and set the document type as Self-Check or Exam.

### Adding Copyright Information

Use the Question Properties dialog box to add copyright information to the current question.

1. Click the **Teacher Tool Palette** icon  > **Question Properties**.

The Question Properties dialog box opens.

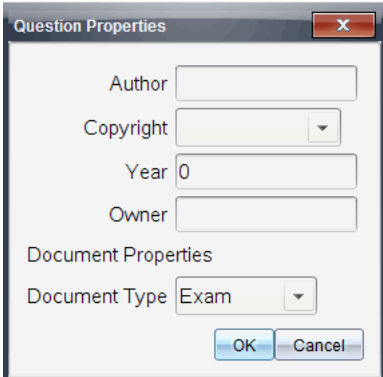

2. Type the author's name and move to the **Copyright** field.  
**Note:** TI-Nspire™ software allows you to use questions from more than one author in the same document. Therefore, the information that you enter about the author and copyright is not global. You must enter the relevant information for each different question.
3. Select whether the question is public domain or has a copyright assigned to it and move to the **Year** field.
4. Type the year the question was copyrighted and move to the **Owner** field. If you are copyrighting a new question, type the current year (example: 2012).
5. Type the name of the person or entity that owns the copyright.
6. Click **OK**.

## Setting Self-Check and Exam Document Types

When you define a document as Self-Check or Exam, all of the questions in that document will be either Self-Check or Exam.

- When you define the document type as Self-Check, students can check the answers against the answers provided by the teacher.
- In Exam mode, when you enter a suggested response to a question, students cannot check the answers. You can use Exam mode to automatically grade student responses.



1. Click the **Teacher Tool Palette** icon > **Question Properties**.
2. In the Document Type field, click **Exam** or **Self-Check**.
3. Click **OK**.

## Understanding the Configuration Tool

The Configuration tool allows you to set properties specific to each question type you insert. Properties include the response type, the number of responses (if applicable), the correct answer, and other options.

For example, you can specify the correct answer to a question, and set the scale, axes, and grid on a graph. You can add a 2D math expression on the question types that contain a Correct Answer field.

Each question type has a unique set of options. The options are explained for each question type in the *Adding Questions* section.

The configuration settings are retained when you copy and paste a question from one document to another.

## Adding Configuration Options

1. Click the down arrow on the Configuration bar in the Documents Toolbox to open the Configuration tool.

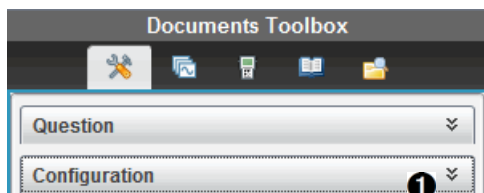

- 1 Click to open the Configuration tool.

- Click the down arrow next to the choices you want to edit, and type the applicable text.

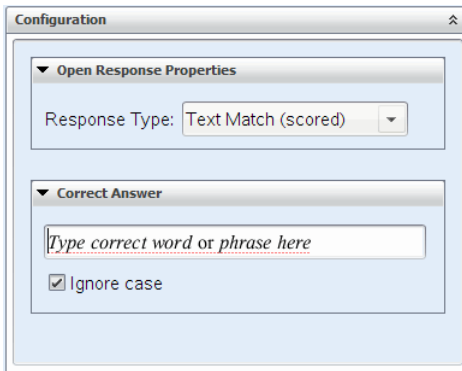

- Close the Configuration panel. The options you chose are saved when you save the document.

## Formatting Text and Objects

Use the text formatting tools to format text in sections of questions that allow text input.

The formatting toolbar also contains the Document Tools  icon to provide easy access to the Question and Configuration tools.

For more information on formatting text and objects, see *Working with TI-Nspire™ Documents*.

## Adding Images to Questions

You can add images to the Question Text Area of most questions. On some question types, you can add an image in the Student Answer or Suggested Response Area of a question.

Adding images provides a visual aid to help explain the context of the question, or as a background on a graph.

Choose the image from a set of images on your computer, or copy and paste an image from a different application into the Question Text Area. For more information, see *Working with Images*.

### Image Types Available

The following file types can be used in the Question application:

- .jpg

- .jpeg
- .bmp
- .png

**Note:** The transparency feature of .png is not supported. Any transparent .png backgrounds will appear as white.

## Adding Images Using the Insert Command

1. Click **Insert > Image**.

The Insert Image dialog box opens.

2. Navigate to the location of the image and select it.
3. Click **Open**.

The image appears in the question.

## Adding Images Using the Clipboard

To copy an image to the Clipboard from a TI-Nspire™ document, image file, or another program, press **Ctrl + C** (Mac®: **⌘ + C**).

To paste the image into the question, press **Ctrl + V** (Mac®: **⌘ + V**).

## Adding Questions

You can add the following types of questions:

- Multiple Choice
  - Custom
  - ABCD
  - True/False
  - Yes/No
  - Always/Sometimes/Never
  - Agree/Disagree
  - Strongly Agree...Strongly Disagree
- Open response
  - Explanation (not auto-graded)
  - Text Match (auto-graded)
- Equations and Expressions
  - $y=$
  - $f(x)=$

- Expression
- Coordinate Points and Lists
  - (x,y) numerical input
  - Drop Point(s)
  - List(s)
- Image
  - Label
  - Point on
- Chemistry

When you select a question type, a brief explanation of the question is displayed at the bottom of the Choose Question Type dialog box.

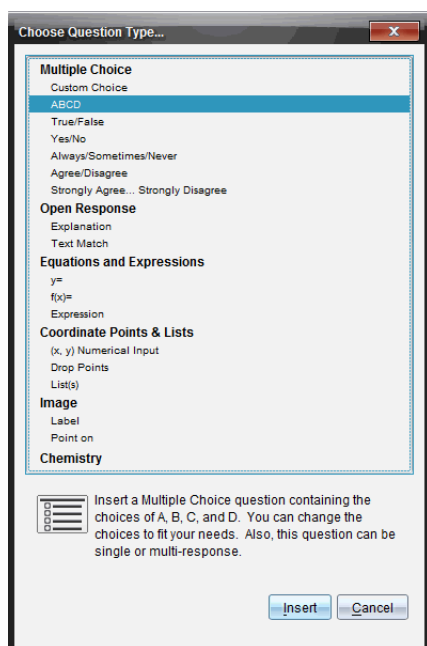

When you open a question template, the cursor is in the Question text area.

## Adding a Multiple Choice Question

This example shows how to add a custom multiple choice question. A custom multiple choice question allows you to specify answers your students can select. You can then select one or more responses as correct to help you when grading or to help students check questions that are in Self-Check mode.

Which of the following are roots of $x^2 = 9$ ? Mark all that apply.	
<input type="checkbox"/>	9
<input type="checkbox"/>	3
<input type="checkbox"/>	-3
<input type="checkbox"/>	-9
<input type="checkbox"/>	3i
<input type="checkbox"/>	-3i

To add a custom multiple-choice question:

1. Click **Insert > Question**.

The Choose Question Type dialog box opens.

2. Click **Custom Choice** under the **Multiple Choice** heading.

3. Click **Insert**.

The Custom Choice template opens with the cursor in the Question text area.

Two response options exist in the template by default.

4. Type the question.

- You can type any combination of text, math expressions, and chemical equations in the Question Area and Suggested Response area.

- You can add an image in the question text area.

5. Press **Enter** to add another question line, or press **Tab** to go to the first Correct Answer button.

6. Type the response options. Add an image, if desired.

7. Press **Enter** to add other response options, and add the response text.

- Press **Delete** to clear or delete a response.
- Press **Backspace** to delete an empty response line.





- Open the Configuration tool. Select the response type as Explanation or Text Match, and type the correct answer.
  - The Explanation response type allows students to give answers that closely match your suggested response.
  - The Text Match response type requires students to exactly match your suggested response. Select the **Ignore Case** check box if capitalization is not important.
  - You can type any combination of text, math expressions, and chemical equations in the Correct Answer area.

## Adding an Equation Question

An equation question prompts the student to write an equation in the form of  $y=$  or  $f(x)=$ , or to respond with a number or expression.

This example shows how to add a  $y=$  question.

The screenshot displays a software interface for creating a question. On the left, there is a text area containing the instruction "Expand the right side of the equation:" followed by the equation  $y = (x + 3)(x - 5)$ . Below this is a "y=" prompt with a text input field containing the text "Complete the equation". On the right, there is a coordinate plane with x and y axes. The x-axis is labeled from -10 to 10, and the y-axis is labeled from -6.67 to 6.67, with a tick mark at 1.

- Click **Insert > Question**.  
The Choose Question Type dialog box opens.
- Select **y=** under **Equations and Expressions**.
- Click **Insert**.  
The equation template opens with the cursor in the Question text area.
- Type the question.
  - You can type any combination of text, math expressions, and chemical equations in the Question Area.
  - You can add an image in the question text area.
  - Press **Tab** or use the mouse pointer to navigate between fields.
- Enter a suggested response, if desired.

6. Press **Enter** to add other response options, and add the response text.
  - Press **Delete** to clear or delete a response.
  - Press **Backspace** to delete an empty response line.
7. Open the Configuration tool to set the number of responses, the correct answer, and whether the students should show their work. You can also add a graph that will show in the Question area.

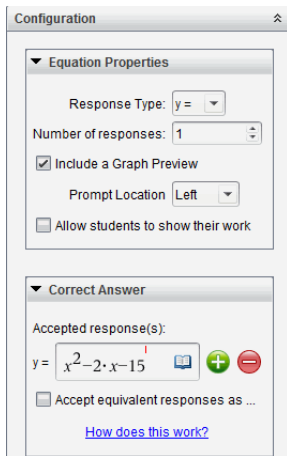

- The number of responses can range from 1 to 5.
  - The **Show your work** option includes areas for the students to write their starting point, their steps, and their final answer. The option to show work is disabled if multiple responses are allowed.
  - To add a graph in the Question area, check **Include a Graph Preview**. The Question text area splits to show a graph on the right.
  - When you are in the graph, the Graphs & Geometry toolbox is available to allow you to add functions.
- Note:** Only the teacher can edit the graph. Students can only view and zoom the graph.
- Click  to add additional fields for multiple correct answers. For example, you might want to accept both  $y=(x+1)(x+2)$  and  $y=(x+2)(x+1)$  as correct answers.
  - Select whether or not to accept equivalent responses as correct.

- If you *do not* check **Accept equivalent responses as correct**, the student response is marked correct if it is an exact text match to one of the accepted responses you entered.
- If you *do* check **Accept equivalent responses as correct**, the student response is marked correct if it is equivalent to any accepted response you entered. For example, if you typed  $x+2$  as the correct answer, and the student submits  $2+x$ , this response is equivalent to the accepted response and is automatically graded as correct. Spaces, case differences, and extra parentheses are ignored when the software evaluates student answers. For example,  $y=2x+1$  is evaluated the same as  $Y = 2X + 1$ .

## Adding an Expression Question

An expression question prompts the student to respond with a number value or an expression.

<p>The dog walker earns \$12 per hour, and she spends \$2 on gas getting to and from her client's house. She walks the dog for 30 minutes each day. Write an expression showing how much money she earns in one day.</p>
<p>Enter expression</p>

1. Click **Insert > Question**.

The Choose Question Type dialog box opens.

2. Click **Expression** under **Equations and Expressions**.
3. Click **Insert**.

The expression template opens with the cursor in the Question text area.

4. Type the question.

- You can type any combination of text, math expressions, and chemical equations in the Question area.
- You can add an image in the Question area.

5. In the Expression type response, enter a starting expression, if desired. The student sees the starting expression.
6. Enter a suggested response, if desired.
  - If you set the response type as Number, the response fields are math boxes and accept only number values such as 1/3.
  - If you set the response type as Expression, the response fields are expression boxes and accept only expression inputs such as 2(3+5).
7. Open the Configuration tool to set the response type as Number or Expression, set whether or not the students should show their work, and enter a correct answer. You can also set a tolerance for Number types, or equivalent responses for Expression types.

▼ Expression Properties

Response Type: Expression

Allow students to show their work

---

▼ Correct Answer

Accepted numerical response:

Tolerance: ± 0

Accepted expression response(s):

$\frac{12}{2} - 2$

Accept equivalent responses as ...

[How does this work?](#)

- The **Show your work** option includes areas for the students to write their starting point, their steps, and their final answer.
- In the Number type response, enter the accepted numerical response and the tolerance. Student responses are marked correct if they fall within the tolerance interval you specify.
- Specifying a tolerance of zero indicates you are looking for the exact number answer. Not specifying a tolerance is the same as specifying a tolerance of zero.
- Student answers are considered correct if they are numerically equivalent to the correct answer. Spaces, case differences, and extra parentheses are ignored when the software evaluates student answers.
- In the Expression type response, you can add additional fields (up to 10) for multiple correct answers.

- In the Expression type response, click  to open the Templates and Symbols catalog that allows you to enter 2D math expressions.
- In the Expression type response, you can select whether or not to accept equivalent responses as correct.
  - If you *do not* check **Accept equivalent responses as correct**, the student response is marked correct if it is an exact text match to one of the accepted responses you entered.
  - If you *do* check **Accept equivalent responses as correct**, the student response is marked correct if it is equivalent to an accepted response you entered. For example, if you typed  $x+2$  as the correct answer, and the student submits  $2+x$ , this response is equivalent to the accepted response and is automatically graded as correct. Spaces, case differences, and extra parentheses are ignored when the software evaluates student answers. For example,  $x+2$  is evaluated the same as  $X + 2$ .

**Important:** Students can enter the starting expression you supply and have this response automatically graded as correct. For example, if you ask students to factor  $x^2-7x+12$  and stipulate the correct answer is  $(x-3)(x-4)$ , the student can submit a response of  $x^2-7x+12$ . This response is automatically graded as correct because it is equivalent to the accepted answer. You must manually mark this student response as incorrect in either the Review or Portfolio Workspaces. See the chapters for those workspaces for more information on marking and grading responses.

## Adding an (x,y) Numerical Input Question

An (x,y) numerical input question prompts the student to respond with a coordinate.

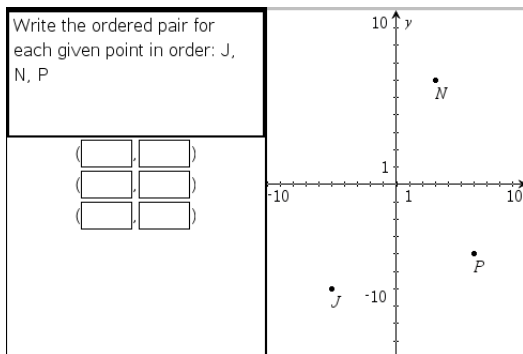

1. Click **Insert > Question**.

The Choose Question Type dialog box opens.

2. Click **(x,y) Numerical Input** under **Coordinate Points & Lists**.

3. Click **Insert**.

The template opens with the cursor in the Question text area.

4. Type the question.

- You can type any combination of text, math expressions, and chemical equations in the Question area.
- You can add an image in the Question area.
- Press **Tab** or use the mouse pointer to navigate between fields.

5. Enter a suggested response, if desired.

- The response fields are expression boxes and accept only expression inputs.

6. Press **Enter** to add other response options (up to five), and add the response text.

- Press **Delete** to clear or delete a response.
- Press **Backspace** to delete an empty response line.

7. Open the Configuration tool to set the number of points, add a graph preview, enter a correct answer, and set equivalent responses as correct.

▼ Coordinate Point Properties

Number of Points: 3



Include a Graph Preview



Prompt Location: Left



---



▼ Correct Answer



Acceptable Answer(s):



( -5 , )  

( -6 , )  



( 3 , )  

( 6 , )  

( 6 , )  

( -4 , )  

Accept equivalent responses as ...

- The number of points can range from 1 to 5.
  - Click  to add additional fields for multiple correct answers. You can type any combination of text, math expressions, and chemical equations in the correct answer fields.
  - Click  to open the Templates and Symbols catalog that allows you to enter 2D math expressions.
  - To add a graph in the Question area, select **Include a Graph Preview**. The Question text area splits to show a graph on the right and the student prompt area on the left. To change the location of the graph, click the down arrow next to **Prompt Location** and choose the desired location for the graph in the student prompt area.
  - When you are in the graph, the Graphs & Geometry tools are available to allow you to add functions.
- Note:** Only the teacher can edit the graph. Students can only view and zoom the graph.
- Select whether or not to accept equivalent responses as correct.
    - If you *do not* check **Accept equivalent responses as correct**, the student response is marked correct if it is an exact text match to one of the accepted responses you entered.
    - If you *do* check **Accept equivalent responses as correct**, the student response is marked correct if it is equivalent to any



accepted response you entered. For example, if you typed  $(-0.5, .75)$  as the correct answer, and the student submits  $(-.5, .75)$  or  $(-1/2, 3/4)$ , and so forth, the student response is equivalent to the accepted response and is automatically graded as correct.

## Adding a Drop Points Question

A drop points question inserts a graph and prompts the student to drop points on the graph in response to your question.

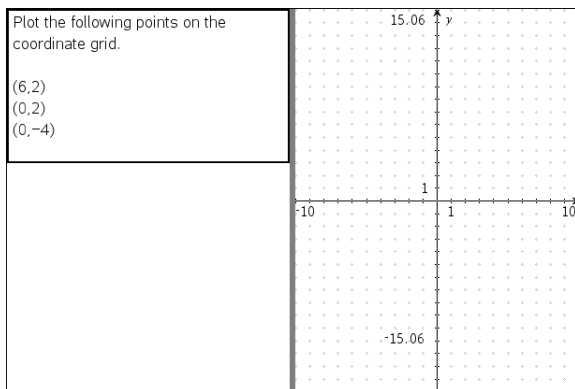

1. Click **Insert > Question**.

The Choose Question Type dialog box opens.

2. Select **Drop Points** under **Coordinate Points & Lists**.
3. Click **Insert**.



The drop points template opens with the cursor in the Question text area.

The graph is in the Student answer area.

- When you are in the graph, the Graphs & Geometry tools are available to allow you to add functions.

**Note:** Only the teacher can edit the graph. Students can only view, zoom, or place points on the graph.

4. Type the question.
  - You can type any combination of text, math expressions, and chemical equations in the Question area.
  - You can add an image in the Question Area.
  - Press **Tab** or use the mouse pointer to navigate between fields.

- Open the Configuration tool to set the number of points, hide or show coordinates, and enter a correct answer.
  - The number of points can range from 1 to 5.
  - Showing coordinates is turned off by default. Select the check box to display coordinate labels on the graph.
  - Click  to add additional fields for multiple correct answers. You can type any combination of text, math expressions, and chemical equations in the correct answer fields.
  - Click  to open the Templates and Symbols catalog that allows you to enter 2D math expressions.

## Adding a Lists Question

A Lists question inserts a list and prompts students to enter data in the lists in response to your question.

Submit the following data - distance in miles between home and work (distance) and the travel time in minutes (time)	distance	time
	1	
	2	
	3	
	4	
	5	
	6	
	7	
	8	
	9	
	10	
	11	
	12	
	13	
	14	
	15	

- Click **Insert > Question**.

The Choose Question Type dialog box opens.
- Select **List(s)** under the **Coordinate Points & Lists** question from the Choose Question Type dialog box.
- Click **Insert**.

The List template opens with the cursor in the Question text area.
- Type the question.
  - You can add columns or rows, change the name of the lists, and input data in the lists, using the same functions allowed in the Lists & Spreadsheet application.

5. Enter initial data in the lists, if desired.
6. Open the Configuration tool to set the number of lists for the student responses.
  - The number of lists can range from 1 to 5.
  - Lists must have names. The default names are **List1**, **List2**, and so forth.

### Adding an Image: Label Question

An Image: Label question inserts an image. You can add blank fields to the image and have students fill in the blanks in response to your question.

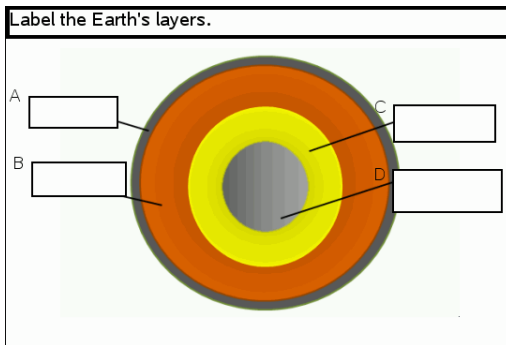

1. Click **Insert > Question**.  
The Choose Question Type dialog box opens.
2. Select **Label** under **Image**.
3. Click **Insert**.  
The Image: Label template opens with a blank background and one label. This is where the image for the question is inserted.
4. Type the question.
  - You can type any combination of text, math expressions, and chemical equations in the Question area.
  - Press **Tab** or use the mouse pointer to navigate between fields.
5. Insert an image in the bottom portion of the question template.
6. Open the Configuration tool to set the number of responses and to enter answers for each label.

Configuration

Image Analysis Question Properties

Number of Responses: 4

Answers

A crust

B mantle

C outer core

D inner core

Ignore Case

- The number of responses determines the number of labels on the image. Each new response gives the label a unique identifier, such as A, B, C, and so forth. Drag the labels to the desired location on the image.

**Note:** If you set more than 26 responses, the labels are identified with numbers, starting with 1. You can insert a maximum of 35 labels.

- In the answers area, click  to open the Templates and Symbols catalog that allows you to enter 2D math expressions.
  - If the label text is too large to fit in the default label size, grab and drag the borders of the label to resize it.
7. Type a suggested response in the labels, if desired. Select the **Ignore case** check box if capitalization is not important.
- You can type any combination of text, math expressions, and chemical equations in the response area.
  - As you type the suggested response, a ghosted image of your answer appears in the respective label on the image. If the suggested response is too large for the default label size, grab and drag the borders of the label to resize it.

### Adding an Image: Point on Question

An Image: Point on question inserts an image. Add check boxes to the image and have students place a check mark in the correct boxes in response to your question.

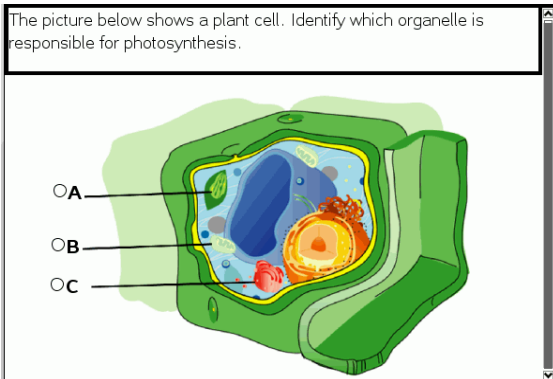

1. Click **Insert > Question**.

The Choose Question Type dialog box opens.

2. Select **Point on** under **Image**.

3. Click **Insert**.

The Image: Point on template opens with a blank background and one point. This is where the image for the question is inserted.

4. Type the question.

- You can type any combination of text, math expressions, and chemical equations in the Question area.
- Press **Tab** or use the mouse pointer to navigate between fields.

5. Open the Configuration tool to set the response type, number of responses, and correct answer.

- The Response Type makes the point a circle for Single Response and changes to a square for Multiple Responses to indicate students can select more than one box.
- The number of responses determines the number of points on the image. Each new response gives the point a unique identifier, such as A, B, C, and so forth. Drag the points to the desired location on the image.

**Note:** If you set more than 26 responses, the points are identified with numbers, starting with 1. You can insert a maximum of 35 points.

6. Click a point or points as a suggested response, if desired.



# Polling Students

The Quick Poll tool lets you “poll” your students. A poll is a survey you send to students that they immediately receive on their handhelds or laptops. After students receive the poll, they can send responses back to your computer. Quick Poll is available from all workspaces. As you receive student responses, use the Review Workspace to review the responses.

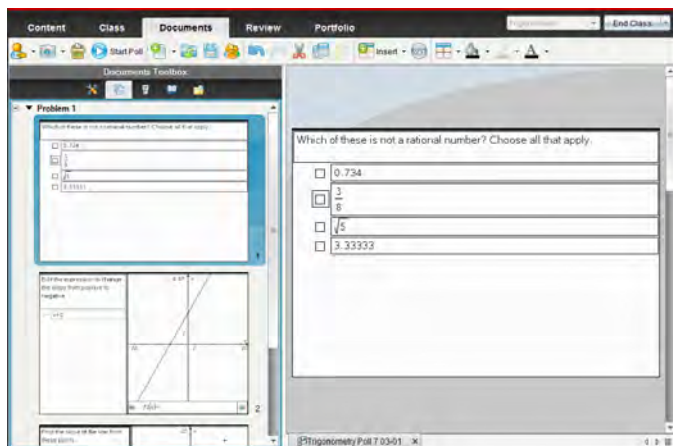

When you click the Quick Poll icon  from any workspace, the Documents Workspace opens, and you can start the Quick Poll. Starting the Quick Poll opens the Review Workspace. You can switch to any workspace while a poll is in progress, but you can only stop the poll from the Documents or Review Workspaces.

You can send the following types of questions:

- Multiple Choice
  - Custom Choice
  - ABCD
  - True/False
  - Yes/No
  - Always/Sometimes/Never
  - Agree/Disagree
  - Strongly Agree...Strongly Disagree

- Open response
  - Explanation (not auto-graded)
  - Text Match (auto-graded)
- Equations and Expressions
  - $y=$
  - $f(x)=$
  - Expression
- Coordinate Points and Lists
  - $(x,y)$  Numerical Input
  - Drop Points
  - List(s)
- Image
  - Label
  - Point on
- Chemistry

When you select a question type, a brief explanation of the question is displayed at the bottom of the Choose Question Type dialog box.

## ***Opening the Quick Poll Tool***

You can open the Quick Poll tool from any workspace. You can send a poll from an existing document, or open a new document to start a poll.

Before you begin, make sure a class is in session.

1. Click **Tools > Quick Poll** or click  .

The Choose Question Type dialog box opens.



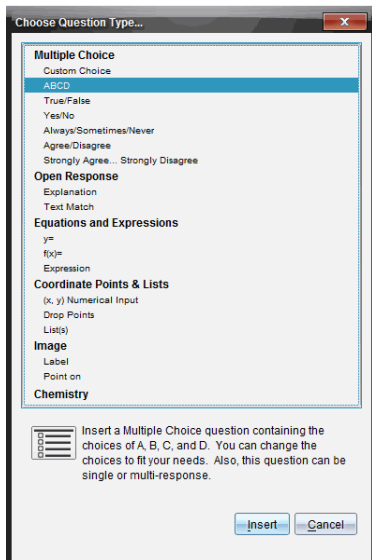

2. Select a question type and click **Insert**.

A new document opens with the question template open and the cursor in the Question text area.

<input type="radio"/>	True
<input type="radio"/>	False

Quick Poll documents are named *<Class name, Quick Poll Set#, mm-dd.tns>*. For example: Algebra1 - Mrs. Smith QP2 10-26.tns. You can rename the poll when you save it.

**Note:** All Quick Polls for one class session are contained in one tab in the Documents Workspace. A new tab is started when the number of questions in the poll exceeds 30, or when you start a new class session.

**Note:** For more information about question types and about creating and configuring questions, see *Using Question in the Teacher Software*.

## ***Sending a Quick Poll***

After you have selected the Quick Poll question, entered the information, and selected options, you are ready to send the poll to your students.

- ▶ To send the Quick Poll question, click **Start Poll** .

The poll is immediately sent to students. The Quick Poll interrupts the active TI-Nspire™ document, and the poll becomes the active document.

You can stop a poll and restart it at any time.

## **Using Quick Poll Options**

When Quick Poll is active, the **Tools > Quick Poll Options** menu is enabled. Available options differ depending on whether you are using software that supports connected handhelds or connected laptops. The Allow Document Access option is not available in the TI-Nspire™ Navigator™ NC Teacher Software.

- **Allow Document Access.** Allows you to grant or deny students access to the Scratchpad and any documents on their handheld. The students may access a document, do some math, and copy the results back into the poll.

**Note:** If a data collection sensor is attached to the computer or handheld during a Quick Poll that does not have Allow Document Access turned on, the Quick Poll is dismissed and the data collection console becomes active.

- **Allow Resubmit.** Allows the students to submit their responses several times.

## ***Stopping Polls***

You can stop polls at any time. Your students do not need to do anything on their handhelds or computers to stop the poll. When you stop a poll, the students can no longer submit answers.

- ▶ To stop a poll, click **Stop Poll** .



**Note:** If you pause a class while a Quick Poll is running, the Quick Poll remains on the students' handhelds, but students are not able to answer or submit the poll until you resume the class. Pausing class is not available in TI-Nspire™ Navigator™ NC Teacher Software.

## Resending Polls

You can resend a poll from the Review Workspace, without switching workspaces or starting a new question.

The software treats the resent poll like a new poll. Students receive a new poll on top of the open document on their handheld or laptop.

The data from the poll is treated as new data, and does not overwrite any data from the original poll.

- ▶ To resend the same poll you just sent, click **Start Poll** .
- ▶ To resend a previous poll, click the poll in the page sorter and then click **Start Poll** .

The poll is added to the page sorter in the order it was sent. The page sorter indicates it was resent.

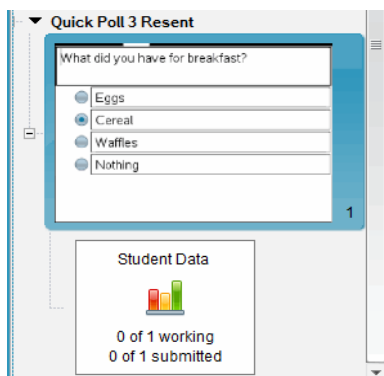

## Sending Polls to Missing Students

You can send the most recent poll to students who were not logged in before the poll was stopped.

**Note:** The Send to Missing option can only be used with the last poll that was sent.

1. In the page sorter, click the last poll that was sent.
2. Click **File > Send to Missing**.

The poll is immediately sent to students who were not logged in when the poll was sent previously, but are currently logged in.

The data gathered from the missing students is added to the data from the last poll.

## ***Saving Polls***

You can save Quick Poll results to the Portfolio Workspace while the poll is still in progress, or you can save a completed set of Quick Poll documents as a .tns file.

You can save to the Portfolio Workspace from either the Class Workspace or the Review Workspace.

When you save the results to the Portfolio Workspace, the polls sent in one class session are saved in one column.

A new column is started when a poll exceeds 30 questions, or when you start a new class session.

- ▶ To save a Quick Poll to the Portfolio Workspace, click **File > Save to Portfolio**.

**Note:** After the first save, subsequent changes to the poll are automatically updated in the Portfolio Workspace until you stop the poll.

You can also save a set of Quick Polls as a Master Document (.tns file). A Master Document contains information that can be used as the answer key for evaluating responses collected from students.

- ▶ To save a Quick Poll as a Master Document, click **File > Save Quick Poll Set as Document**.

**Note:** After you save as a .tns file, any subsequent changes to the poll are *not* updated in the .tns document.

## ***Viewing Poll Results***

Review Quick Poll results in the Review Workspace.

Polls sent in one class session are contained in a Quick Poll tab in the Review Workspace. Each new question is added as a new problem in the page sorter, and the software automatically opens to the last question that was sent. A new tab is started when a poll exceeds 30 questions.

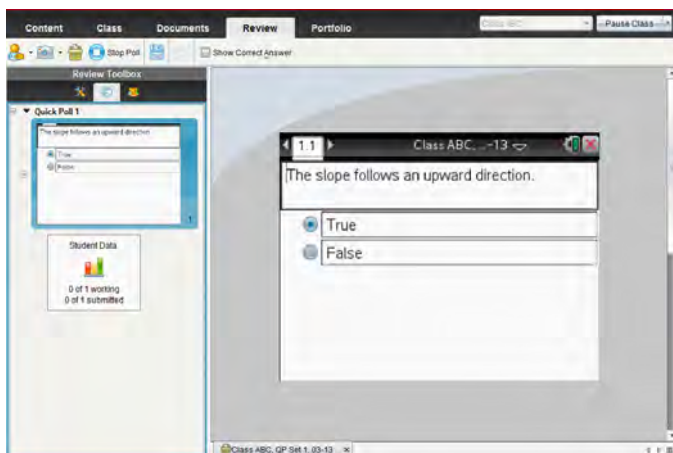

You can view the results as a bar chart, graph, or table. The results automatically update as students send their responses, until you stop the poll.

The following example shows the poll results listed in a table.

Student <sup>△</sup>	Response
Chopra, Laxmi	$y=3-x$
Garcia, Rafe	$y=x-3$
Moore, Jacob	$y=x+3$
Ortega, Carlos	$y=3-x$
Simmons, Nadine	$y=3-x$

For more information about viewing and sorting poll results, see *Using the Review Workspace*.



# Working with TI-Nspire™ Documents

This section describes how to work with TI-Nspire™ documents in the Documents Workspace.

## About Documents

All work that you create and save using TI-Nspire™ applications is stored as a document, which you can share with others using TI-Nspire™ software and with those using handhelds. There are two types of documents:

- TI-Nspire™ document (.tns file)
- PublishView™ document (.tnsp file)

## TI-Nspire™ Documents

A TI-Nspire™ document consists of one or more problems and each problem contains one or more pages. A single page is displayed in the work area. All work occurs in the applications within pages. Because the TI-Nspire™ software and handhelds share the same functionality, you can create TI-Nspire™ documents that can be transferred between the software and a handheld.

## PublishView™ Documents

PublishView™ documents can be printed on a standard piece of paper or published to a website or blog. PublishView™ documents can include formatted text, images, and hyperlinks as well as all TI-Nspire™ applications.

For more information, see *Working with PublishView™ Documents*.

## Creating a New TI-Nspire™ Document

When you open the software, the Documents Workspace opens with a blank document containing one problem. You can add applications and content to this problem to create a document.

**Note:** The Welcome Screen is displayed when you open the software if the "always show this at startup" option is selected. Click an application icon to add a problem with an active application to a new document.

To create a new document, complete the following steps:

1. Click **File > New TI-Nspire™ Document**.

—or—

Click  .

2. Click **New TI-Nspire™ Document**.

The new document opens in the Documents Workspace and you are prompted to select an application. By default, new documents open in your current view: computer or handheld. To change the view, use the **View** menu or click the appropriate icon in the status bar.

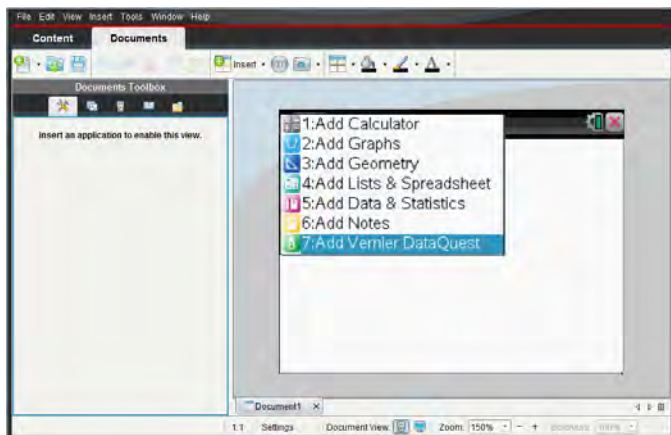

3. Select an application to add a problem to the document.

The problem is added to the document.

## ***Opening an Existing Document***

To open an existing document:

1. Click **File > Open Document**.

—or—

Click  .

The Open dialog box opens.



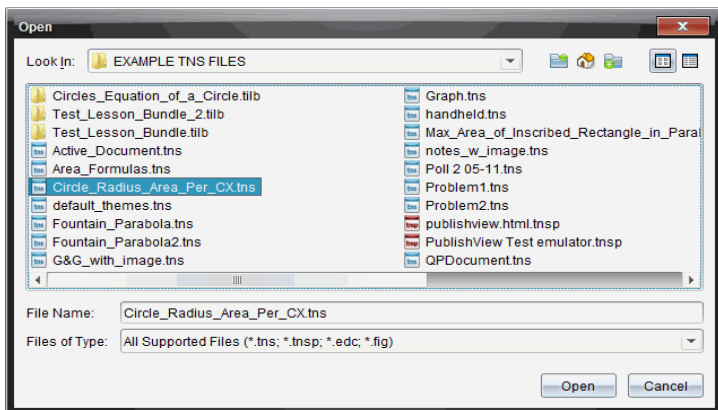

- Use the file browser to locate the file you want to open and click the file to select it.
- Click **Open**.

The document opens in the work area.

**Note:** To select from your 10 most recent documents, click **File > Recent Documents** and select a document from the drop-down list.

## ***Saving TI-Nspire™ Documents***

To save a new document:

- Click **File > Save Document** or click  .

The Save TI-Nspire™ Document dialog box opens.

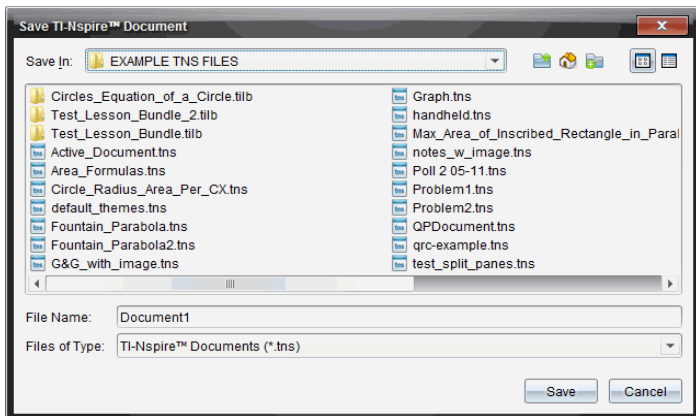

2. Navigate to the folder where you want to save the document or create a folder in which to store the document.
3. Type a name for the new document.
4. Click **Save** to save the document.

The document closes and is saved with the extension .tns.

**Note:** When you save a file, the software looks in the same folder the next time you open a file.

## **Saving a Document with a New Name**

To save a previously saved document in a new folder and/or with a new name:

1. Click **File > Save As**.

The Save TI-Nspire™ Document dialog box opens.

2. Navigate to the folder where you want to save the document or create a folder in which to store the document.
3. Type a new name for the document.
4. Click **Save** to save the document with a new name.

## **Deleting Documents**

File deletions on your computer are sent to the Recycle bin and can be retrieved if the Recycle bin has not been emptied.

**Note:** File deletions on the handheld are permanent and cannot be undone, so be sure that you want to delete the file that you select.

1. Select the document you want to delete.
2. Click **Edit > Delete** or press **Delete**.

The Warning dialog box opens.

3. Click **Yes** to confirm the delete.

The document is deleted.

## **Closing Documents**

- ▶ To close a document, click **File > Close** or click the **Close** icon on the document tab at the bottom of the document.

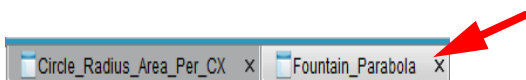







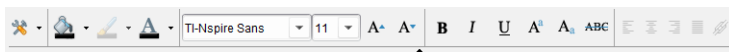

- ▶ If working in tiled view, click the **Close** icon in the upper right corner of the document window.



## Formatting Text in Documents

Use the text formatting tools to format text in TI-Nspire™ applications that allow text input, and to format text in PublishView™ documents. By default, the text formatting toolbar opens in the area above an active document. Options on the toolbar are enabled or disabled depending on the active application.

For example, the following image shows options available in an active Graphs & Geometry document.

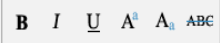

Option	Function
	Click ▼ to open the menu for the active application. This tool enables you to open an application menu regardless of the option selected in the Documents Toolbox.
	Click ▼ to select a background color for highlighting text or choose a fill color for a selected cell.
	Click ▼ to select the line color for an object. For example, in Graphs & Geometry, you can choose a color for a selected shape.
	Click ▼ to select a color for selected text.
	Use these tools to choose a font and set the size of the font. <ul style="list-style-type: none"> <li>• Click ▼ to select a different font from the drop-down box.</li> <li>• To select a specific font size, click ▼ to select a size from the drop-down box.</li> <li>• Click  to increase the font size or click  to decrease the font size incrementally.</li> </ul>

Option	Function
	Click the appropriate tool to apply bolding, italics, or underlining; apply superscript or subscript; or strike out text.
	In a PublishView™ document, use these tools to position text within the header or footer, or in text box. Clicking  opens the Hyperlink dialog box. For more information, see <i>Working with PublishView™ Documents</i> .

## Hiding and Showing the Formatting Toolbar

- ▶ When the formatting toolbar is visible, click ▲ (located under the toolbar) to hide the toolbar.
- ▶ Click ▼ to show the toolbar when the formatting toolbar is hidden.

## Using Colors in Documents

In the TI-Nspire™ applications that allow formatting, you can use color in filled areas of an object, or in lines or text, depending on the application you are using and how you have selected the item. If the icon or menu item that you want to use is not available (dimmed) after you have selected an item, color is not an option for the selected item.

Colors appear in documents opened on your computer and on the TI-Nspire™ CX handheld. If a document containing color is opened on a TI-Nspire™ handheld, colors are displayed in shades of gray.

**Note:** For more information about using color in a TI-Nspire™ application, see the chapter for that application.

## Adding Color from a List

To add color to a fill area, line, or text, complete the following steps:

1. Select the item.
2. Click **Edit > Color** or select where you want to add color (fill, line, or text).
3. Select the color from the list.

## Adding Color from a Palette

To add color using the palette, complete the following steps:

1. Select the object.
2. Click the appropriate toolbar icon.
3. Select the color from the palette.

## Working with Multiple Documents

When multiple documents are open, document names are listed in tabs at the bottom of the work area. Only one document is active at a time, and only the active document is affected by commands from menus or tools.

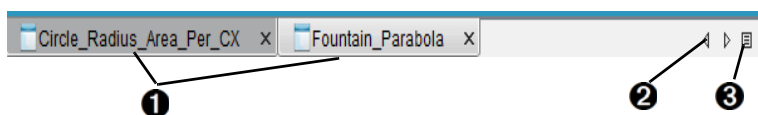

To switch between documents:

- 1 Click the tab to show a document in the work area. This document becomes the active document. If the Show Documents in Tiles view is open, these tabs are not shown.
- 2 Use the right and left arrows to scroll through the list of documents. These arrows are active only when there are too many documents to fit in the window.
- 3 Click the Show List icon to list all open documents. This is useful when you have a large number of documents open and documents names on the tabs may be truncated.

## Working with Multiple Documents in Tiled View

When multiple documents are open, you can view thumbnails of the documents in the work area. To change the view:

- ▶ Click **Window > Show Documents in Tiles**.

Open documents are shown as thumbnails in the work area and the scroll bar becomes active.



The status bar remains available; however, document names now appear in the thumbnail view. Click **Select Window > Show Documents in Tabs** to view one document at a time in the work area.

## ***Working with Applications***

When you first open a new document or add a new problem to a document, select an application from the menu.

The following illustration shows how a problem with the Lists & Spreadsheet application appears in the work area on the right side of the window when Handheld mode is selected.

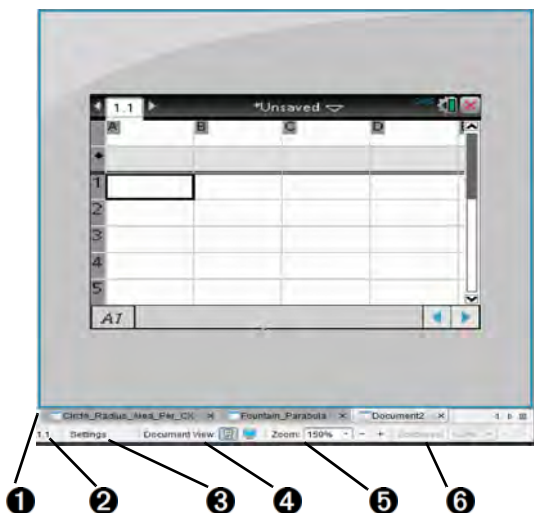

- ❶ **Document name.** This tab contains the document name.
- ❷ **Problem/Page counter.** The first value represents the problem number of the active page, while the second value tells you the page number within the problem. In the example, the counter reads 1.2, indicating Problem 1, Page 2.
- ❸ **Settings.** Enables you to change the Document Settings and Graphs and Geometry Settings for the active document or change the default settings. For more information, see *Using the Documents Workspace*.
- ❹ **Document View.** Enables you to switch between Computer mode and Handheld mode.
- ❺ **Zoom.** In Handheld mode, enables you to increase or decrease the size of the document within the work area.
- ❻ **Boldness.** When in Computer view, you can increase or decrease the boldness of the document.

## Working with Multiple Applications on a Page

You can add up to four applications to a page. When you have multiple applications on a page, the menu for the active application is displayed in the Documents Toolbox. Using multiple applications involves two steps:

- Changing the page layout to accommodate multiple applications.

- Adding the applications.

You can add multiple applications to a page even if an application is already active.

## Adding Multiple Applications to a Page

By default, each page contains space to add one application. To add additional applications to the page, complete the following steps.

1. Click **Edit > Page Layout > Select Layout**.

—or—

Click .

The page layout menu opens.



There are eight page layout options available. If an option is already selected, it is dimmed.

2. Highlight the layout you want to add to the problem or page, and then click to select it.

The new layout is displayed with the first application active.



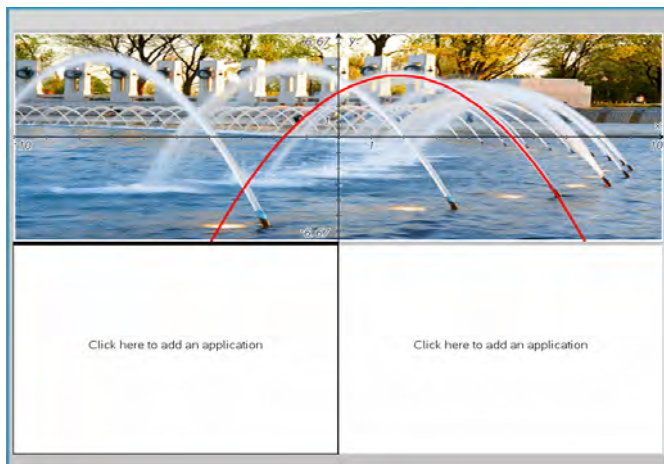

3. In Handheld mode, click **Press menu** to select an application for each new section in the problem or page. In Computer view, select **Click here to add an application**.

### Swapping Applications

To change the position of applications on a page with multiple applications, “swap” the positions of two applications.

1. Click **Edit > Page Layout > Swap Application**.

**Note:** The last active application you worked on is automatically selected as the first application to be swapped.

2. Click the second application to swap.

This action performs the swap.

**Note:** When there are only two work areas, the selected application automatically swaps position with the other application in the work area.

To cancel a swap, press **Esc**.

### Selecting and Moving Pages

To quickly move and rearrange pages in a document that contains multiple pages, use the Page Sorter to list thumbnail views of all pages in the document.

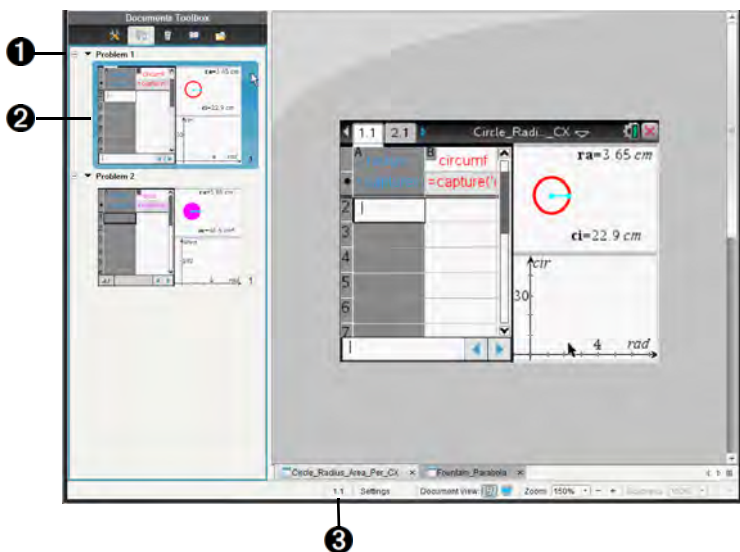

- ❶ **Page Sorter.** Displays thumbnail sketches of all pages in all problems in the current document. Use the scroll bar to view pages off the screen.
- ❷ **Active page.** The page currently highlighted in the Page Sorter and active in the work area.
- ❸ **Problem/Page counter.** Displays the problem number followed by the page number.

## Selecting Pages

The Page Sorter always indicates the active page in the work area.

- If you are working on a page in the work area, this page is indicated in the Page Sorter by a color border.
- If you are actively using the Page Sorter, the active page displayed in the work area has a color border in the Page Sorter pane.
- Clicking on any page in the Page Sorter makes it the active page, and it is displayed in the work area.

## Rearranging Pages

Use the Page Sorter to change the order of pages within a problem.

1. Click to select the thumbnail view of the page in the Page Sorter.

2. Drag the page to the desired position, and release to drop it in the new location.

## Grouping Applications

To group up to four pages into a single page:

1. Click the first page in the series.
2. Click **Edit > Page Layout > Group**.

The next page is grouped with the first page. The page layout automatically adjusts to display all the pages in the group.

To ungroup pages:

1. Click the grouped page.
2. Click **Edit > Page Layout > Ungroup**.

The material becomes individual pages and applications.

## Deleting an Application from a Page

1. Click the application you want to delete.
2. Click **Edit > Page Layout > Delete Application**.

The application is deleted.

To undo the delete, press **Ctrl-Z** (Mac@: ⌘+Z).

## Deleting Pages

1. Select the page you want to delete.
2. Click **Edit > Delete**.

—or—

Click .

—or—

Right-click and click **Delete**.

## Working with Problems and Pages

When you create a new document, a problem is added with one page. When a document has a problem with multiple pages or multiple

problems, click  to open the page sorter view in the Documents Toolbox to view the problems and pages.

## Adding a Problem to a Document

A document can contain up to 30 problems. To add a new problem:

1. Click **Insert > Problem**.

—or—

Click .

2. Click **Problem**.

A new problem with one new page is added to your document.

## Adding a Page to a Problem

Each problem can contain up to 50 pages. To add a new page to a problem:

1. Click **Insert > Page**.

—or—

Click .

2. Click **Page**.

A new page is added to the problem.

3. Select an application to add to the page.

## Copying, Pasting, and Deleting Problems

You can copy and paste a single problem from one location to another within the same document or a different document. You can also delete a problem from the document.

### Copying and Pasting a Problem

To copy and paste the problem:

1. Click  to open the Page Sorter.
2. Click a problem name to select it.
3. Click **Edit > Copy** or press **Ctrl + C** (Mac®: **⌘ + C**).
4. Go to the location where you want the problem to appear.
5. Click **Edit > Paste** or press **Ctrl + V** (Mac®: **⌘ + V**).

The problem is copied to the new location.

## ***Deleting a Problem***

To delete a problem from the document:

1. Click a problem name to select it.
2. Click **Edit > Delete** or press **Ctrl+X** (Mac®: **⌘ + X**).

The problem is deleted from the document.

## ***Renaming a Problem***

To rename a problem:

1. Using the Page Sorter, select the problem name.
2. Right-click and click **Rename**.

The problem name box clears.

3. Type the new name and press **Enter**.

The new name appears in bold to indicate that it has been changed.

## ***Printing Documents***

If your computer is connected to a printer, you can print an open document.

1. Click **File > Print**.

The Print dialog box opens.

2. Select the details of your print job.

The Print dialog box enables you to control the following in your print job:

- The printer
- Print What:
  - Viewable Screen — prints what is visible in the active document.
  - Print All — prints all data and pages in all open documents, including what is not currently visible on the screen.
- Paper size
- The range of TI-Nspire™ pages
- The number of printed copies, up to 100
- Layout:
  - Orientation (portrait or landscape)

- The number of TI-Nspire™ pages to be printed on each sheet (1, 4, or 8) (available in Viewable Screen option only)
- Whether to allow space below each printed TI-Nspire™ page for comments (available in Viewable Screen option only)
- Margins (from .25 inches to 2 inches)
- The option to include documentation information on the printout:
  - Problem and page labels
  - Header (up to two lines)
  - Document name in the footer
- The ability to group the pages by problem
- Print Preview

3. Click **Print**.

**Note:** To restore the Print defaults, click **Reset**.

### **Using Print Preview**

You can also preview the document from the Print dialog box.

1. Select the **Preview** check box.
2. Use the arrows at the top of the right pane to page through the pages in the preview.

## ***Viewing Document Properties and Copyright Information***

### **Viewing Copyright Information**

If a teacher has added copyright information to a document, you can view that information.

1. Click **File > View Copyright Information**.

The Copyright Information dialog box opens.

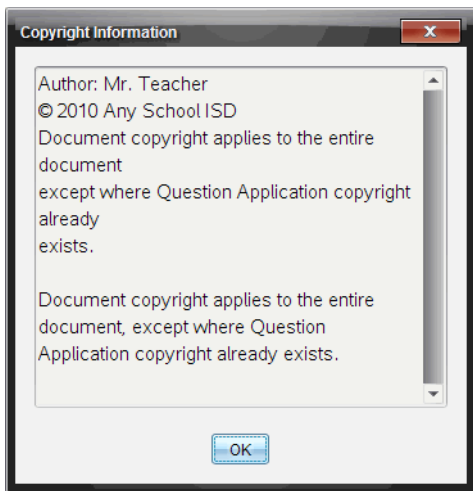

2. Click **OK** to close the dialog box.

### **Protecting a Document (making a document read-only)**

**Note:** This section applies only to the Teacher Software.

Teachers can protect documents to create a document for distribution to your students or for other use. A student who receives a read-only document and makes changes to it will be prompted to save the document as a new file.

To make a document read-only:

1. Open the document.
2. Click **File > Document Properties**.

The Document Properties dialog box opens with the Copyright tab visible.

3. Click the **Protection** tab.

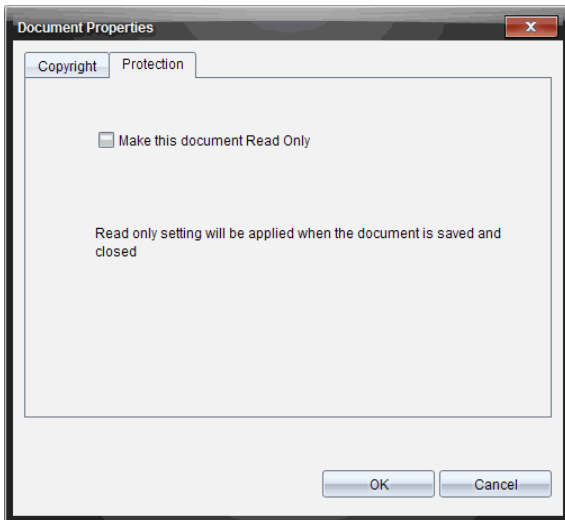

4. Select the **Make this document Read Only** check box.
5. Click **OK**.

### **Adding Copyright Information to a Document**

**Note:** This section applies only to the Teacher Software.

You can add copyright information individually to documents you create or apply the same copyright information to all new documents.

To add copyright information to a document:

1. With the document open, click **File > Document Properties**.

The Document Properties dialog box opens with the **Copyright** tab visible.



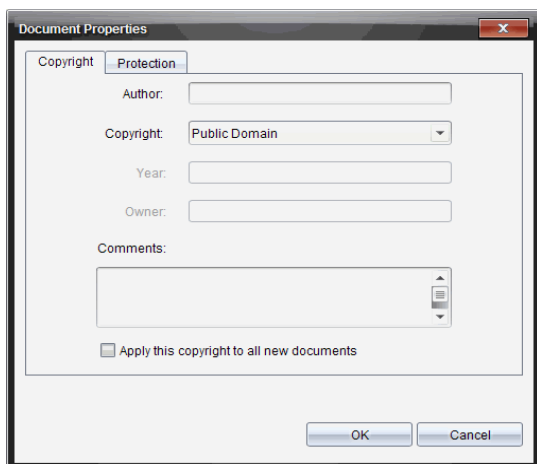

2. Edit the following fields to define the copyright details:
  - Author
  - Copyright (Public Domain or Copyright)  
**Note:** If you select Public Domain, you cannot enter a year or owner.
  - Year
  - Owner
  - Comments
3. To add the supplied information to all new documents from this point forward, select **Apply this copyright to all new documents**.
4. Click **OK** to apply the copyright information to the document.



# Working with PublishView™ Documents

Use the PublishView™ feature to create and share interactive documents with teachers and students. You can create documents that include formatted text, TI-Nspire™ applications, images, hyperlinks, links to videos, and embedded videos in a format that is suitable for printing on a standard piece of paper, publishing to a website or blog, or for use as an interactive worksheet.

PublishView™ features provide layout and editing features for presenting math and science concepts in a document where TI-Nspire™ applications can be interactively and dynamically linked with supporting media, enabling you to bring the document to life. Using the PublishView™ feature:

- Teachers can create interactive activities and assessments used on screen.
- Teachers can create printed materials to complement documents used on TI-Nspire™ handhelds.
- When working with lesson plans, teachers can:
  - Create lesson plans from existing handheld documents or convert lesson plans to handheld documents.
  - Link to related lesson plans or documents.
  - Embed explanatory text, images, video, and links to web resources.
  - Build or interact with TI-Nspire™ applications directly from the lesson plan.
- Students can create reports or projects such as lab reports containing data playback, curve fits, pictures, and video—all on the same sheet.
- Students can print and turn in assignments on a standard piece of paper.
- Students taking exams can use one tool to create a document that contains: all problems on the exam, text, images, hyperlinks, or videos, interactive TI-Nspire™ applications, screen shots, and layout options needed to print a document.

**Note:** PublishView™ documents can be exchanged using the TI-Nspire™ Navigator™ NC system. PublishView™ documents can reside in the Portfolio Workspace, and TI-Nspire™ questions within a PublishView™ document can be automatically graded by the TI-Nspire™ Navigator™ system.

## Creating a New PublishView™ Document

1. From the Documents Workspace, click **File > New PublishView™ Document**.

—or—

Click , and then click **New PublishView™ Document**.

- A blank letter-size document opens in the Documents Workspace. The orientation is portrait, which cannot be changed.
  - The default margin settings for the top and bottom margins are one-inch. There are no settings for side margins.
  - By default, a problem is added to the document.
  - By default, the document contains the page number in a # of # format at the bottom of the sheet.
  - The scroll bars on the right side of the screen and at the bottom of the screen are active.
2. Add TI-Nspire™ applications and PublishView™ objects as needed to complete the document.

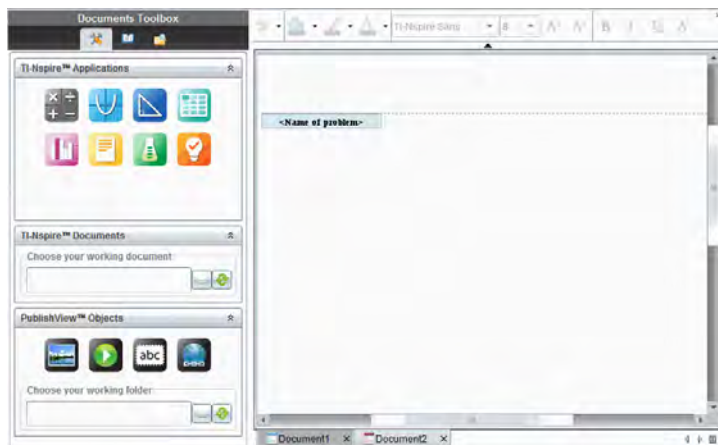

### About PublishView™ Documents

When working with PublishView™ documents, it is important to keep the following points in mind:

- PublishView™ documents are saved as .tnsp files, which distinguishes them from TI-Nspire™ documents (.tns files).

- When inserting PublishView™ objects into a document, the text, image, hyperlink, or embedded video are contained in boxes that can be moved and resized.
- When you insert TI-Nspire™ applications, they work the same way as pages in a TI-Nspire™ document.
- In a PublishView™ document, objects can overlap each other and you can control which object is on top or bottom.
- Objects can be placed and positioned in a PublishView™ document in a free-form fashion.
- You can convert an existing TI-Nspire™ document to a PublishView™ document (.tnsp file).
- When you convert a PublishView™ document to a TI-Nspire™ document (.tns file), TI-Nspire™ applications are converted. PublishView™ objects containing text, hyperlinks, videos, and images are not converted.
- You cannot create or open a PublishView™ document on a handheld. You must convert a PublishView™ document to a TI-Nspire™ document before sending it to a handheld.

### **Exploring a PublishView™ Document**

The following example shows how you might use TI-Nspire™ applications and PublishView™ objects to build a PublishView™ document. In this example, borders are turned on to show the boundaries around the objects. Showing borders enables you to work with objects easily while building a document. When you are ready to print or publish the document to the web, you can select to the hide borders.

## If a Tree Falls...

### Problem 1

You have all heard the joke, "If a tree falls in a forest, will anyone hear it?" In this lesson, we explore the algebra to a falling tree and answer the question, "If a tree falls in your neighborhood, will it land on your car or house?"

#### 1. Explore

Below, explore what happens if a 16 meter pole breaks by grabbing any of the two open circles. How far away from the base of the pole will the poll hit?

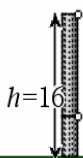

#### 2. Solve It

Can you write a formula for the distance (d) in terms of height (h)?

$$f1(x) := \sqrt{256 - 32 \cdot x}$$

$$h^2 + d^2 = (16 - h)^2$$

$$h^2 + d^2 = 256 - 32h + h^2$$

#### 3. Graph It

Graph your formula as a function.

Think: Do all values of the function apply to the situation above? Modify the function  $t$  to bound the range so that it makes sense.

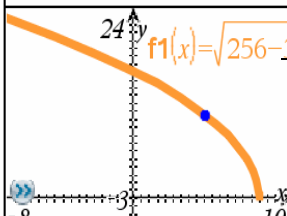

#### 4. Application

When cutting down a tree, it might be good to figure out where the top of the tree will land!

(c) Texas Instruments, Inc., 2010

1 of 1

- Header.** In this example, the header contains the title of the document. When the header area is active, you can type and format text as needed.
- Problem break and name.** In PublishView™ documents, use problem breaks to control the page layout. You can select to hide or show problem breaks. Deleting a problem removes the contents of the problem and removes the space between problems when there are multiple problems. Problem breaks also enable you to use variables in PublishView™ documents. Variables that have the same name are independent of one another if they are used in different problems.

- ③ **Text boxes.** In this example, the introduction text and the text in boxes 1, 2, 3, and 4 is contained in text boxes. You can insert text and hyperlinks into a PublishView™ document using a text box. Text boxes can be resized and positioned as needed. PublishView™ text boxes are not retained when you convert a PublishView™ document to a TI-Nspire™ document.
- ④ **TI-Nspire™ applications.** In this example, the author uses Graphs & Geometry to show the math functions. When a TI-Nspire™ application is active in a PublishView™ document, the appropriate application menu opens in the Documents Toolbox. You can work in a TI-Nspire™ application just as you would in a TI-Nspire™ document. When you convert a PublishView™ document to a TI-Nspire™ document, applications are retained.
- ⑤ **Notes application.** You can also use the TI-Nspire™ Notes application to add text to a PublishView™ document. Because Notes is a TI-Nspire™ application, it will be retained when you convert the PublishView™ document to a TI-Nspire™ document. Using the Notes application enables you to use an equation editor and can contain TI-Nspire™ math templates and symbols.
- ⑥ **Video.** This is an example of a video that is embedded in a PublishView™ document within a frame. Users can start and stop the video using the controls. Frames containing videos and images can be resized and positioned in the document as needed.
- ⑦ **Footer.** By default, the footer area contains the page number, which cannot be edited. You can add other text above the page number if needed. Like the header, you can format text as needed.

## Using the Status Bar in a PublishView™ Document

When a PublishView™ document is open, options on the status bar are different than when working in a TI-Nspire™ document.

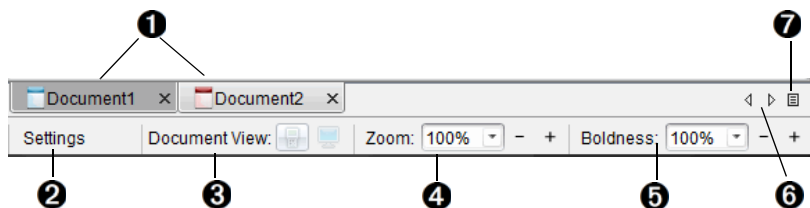

- ❶ Document names are displayed in tabs. If multiple documents are open, the document names are listed. You can have TI-Nspire™ and PublishView™ documents open at the same time. In this example, Document 1 is an inactive TI-Nspire™ document (□). Document 2 is the active PublishView™ document (▨). Click the X to close a document.
- ❷ Click **Settings** to change Document Settings. You can specify settings that are specific to an active document or set default settings for all PublishView™ documents. When you convert a TI-Nspire™ document into a PublishView™ document, the settings in the TI-Nspire™ document convert to the settings defined for PublishView™ documents.
- ❸ **Document View** is not active in a PublishView™ document. You cannot switch between computer view and handheld view.
- ❹ Use the **Zoom** scale to zoom the active document in or out from 10% to 500%. To set a zoom, type a specific number, use the + and - buttons to increase or decrease by increments of 10%, or use the drop-down box to choose preset percentages.
- ❺ In TI-Nspire™ applications, use the **Boldness** scale to increase or decrease the boldness of text and line thickness within applications. To set the boldness, type a specific number, use the + and - buttons to increase or decrease by increments of 10%, or use the drop-down box to choose preset percentages.  
  
For PublishView™ objects, boldness is used to match text within TI-Nspire™ applications to other text on the PublishView™ sheet. It can also be used to increase the visibility of TI-Nspire™ applications when presenting a document to a class.
- ❻ When there are too many open document names to show in the status bar, click the forward and backward arrows (◀ ▶) to move through the documents.
- ❼ Click □ to see a list of all open documents.



## ***Saving PublishView™ Documents***

### **Saving a New Document**

1. Click **File > Save Document**.

—or—

Click  .

The Save TI-Nspire™ Document dialog box opens.

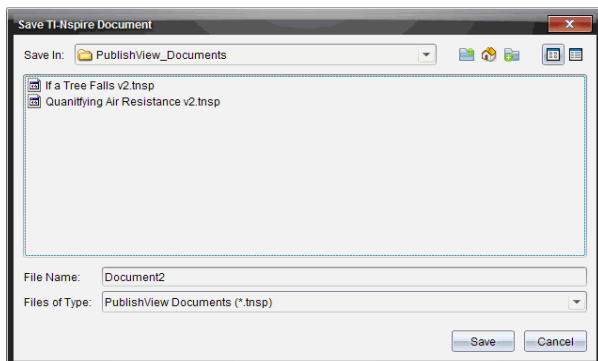

2. Navigate to the folder in which you want to save the document.

—or—

Create a folder in which to store the document.

3. Type a name for the new document.
4. Click **Save**.

The document closes and is saved with the extension .tnsp.

**Note:** When you save a file, the software first looks in the same folder the next time you open a file.

### **Saving a Document with a New Name**

To save a previously saved document in a new folder and/or with a new name:

1. Click **File > Save As** from the menu.

The Save TI-Nspire™ Document dialog box opens.

2. Navigate to the folder in which you want to save the document.

—or—

Create a folder in which to store the document.

3. Type a new name for the document.
4. Click **Save** to save the document with a new name.

**Note:** You can also use the **Save As** option to convert documents from TI-Nspire™ files to PublishView™ files or convert PublishView™ files to TI-Nspire™ files.

## ***Exploring the Documents Workspace***

When you create or open a PublishView™ document, it opens in the Documents Workspace. Use the menu options and the toolbar just as you would when working with a TI-Nspire™ document to:

- Navigate to existing folders and documents using Content Explorer
- Open existing documents
- Save documents
- Use the copy, paste, undo, and redo options
- Delete documents
- Access TI-Nspire™ application-specific menus
- Open the Variables menu in TI-Nspire™ applications that allow variables
- Access and insert math templates, symbols, catalog items, and library items into a PublishView™ document

**Note:** For more information, see *Using the Documents Workspace*.



## **Exploring the Documents Toolbox**

When a PublishView™ document is active, the Documents Toolbox contains tools needed for working with PublishView™ documents. You can add TI-Nspire™ applications to a problem, insert parts of existing TI-Nspire™ documents into a problem, and add PublishView™ objects.

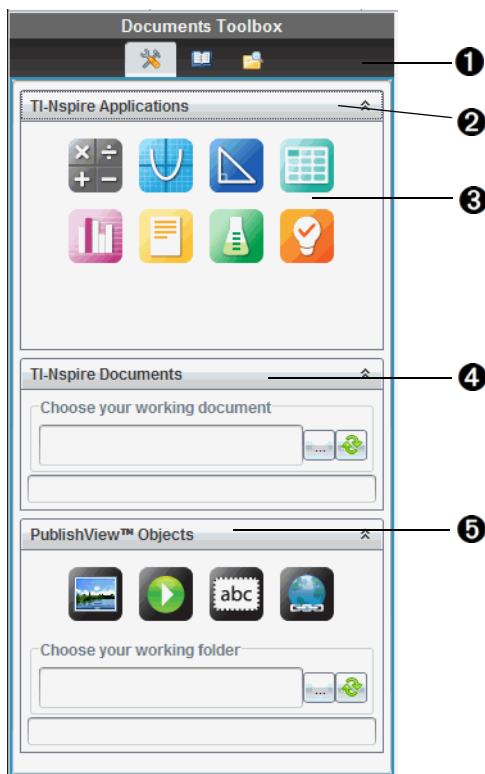

The Documents Toolbox opens when you create a new PublishView™ document or open an existing PublishView™ document. When working in a PublishView™ document, Page Sorter and TI-SmartView™ emulator are not available.











❶ In a PublishView™ document:

- Click  to open the application menu and tools needed to work with TI-Nspire™ applications and PublishView™ objects.
- Click  to open the Utilities panel where you can access Math Templates, Symbols, the Catalog, Math Operators, and Libraries.
- Click  to open Content Explorer.

**Note:** For more information, see *Using the Documents Workspace*.





- ❷ Click  to collapse a pane containing a menu. Click  to expand a pane.

3 TI-Nspire™ applications. Move an icon to a problem to insert an application:

-  Calculator
-  Graph
-  Geometry
-  Lists & Spreadsheet
-  Data & Statistics
-  Notes
-  Vernier DataQuest™
-  Question (Available in TI-Nspire™ Teacher Software, TI-Nspire™ Navigator™ Teacher Software, and TI-Nspire™ Navigator™ NC Teacher Software).

4 **TI-Nspire™ Documents.** Use this tool to locate and insert existing TI-Nspire™ documents (.tns files) into a problem.

5 **PublishView™ Objects.** Use this tool to move the following objects into a problem:

-  Image
-  Video
-  Text box
-  Hyperlink

## Using Menus and the Toolbar

When working in a PublishView™ document, select options from the menus or the toolbar in the Documents Workspace to work with content and objects. When you insert an object into a PublishView™ document, you can manipulate it using the same tools as you would when working with a TI-Nspire™ document. In PublishView™ documents, you can:

- Right-click on an object to open a context menu, which displays the actions that can be performed on that object.

- Use add, insert, and paste to add objects to a PublishView™ document.
- Use delete and cut to remove objects from a PublishView™ document.
- Move objects from one place to another within a PublishView™ document.
- Copy objects from one document and paste them into another PublishView™ document.
- Resize and scale objects such as text boxes and images.
- Change the font face and size and apply formatting such as italics, bold, underline, and color to text.

**Note:** For more information, see *Using the Documents Workspace*.

## **Using Context Menus**

In TI-Nspire™ applications and in PublishView™ documents, context menus provide a list of options specific to the task you are working on. For example, when you right-click a cell while working in the TI-Nspire™ Lists & Spreadsheet application, a context menu opens providing a list of actions that you can perform on that cell. When you right-click the border of a text box in a PublishView™ document, the context menu provides actions that can be performed on the text box.

### ***Context Menus in TI-Nspire™ Applications***

When you insert a TI-Nspire™ application into a PublishView™ document, the application menu and the context menus associated with that application are available and work the same way they work in a TI-Nspire™ document.

### ***Context Menus in PublishView™ Documents***

In PublishView™ documents, context menus provide shortcuts to frequently performed tasks. Context menus are specific to an object or area:

- The Sheet context menu provides options for working with the layout of the sheet and document.
- Object context menus provide options for manipulating the object.
- Content-sensitive context menus provide options for working with the content inside the object such as text or a video.

## Working with PublishView™ Objects

In a PublishView™ document, text, hyperlinks, images, and videos are contained in PublishView™ objects. You can move, resize, copy and paste, and delete an object within a PublishView™ document. Objects can also be positioned so that one overlaps the other.

Within a document, PublishView™ objects can exist in three states: unselected, selected, and interactive.

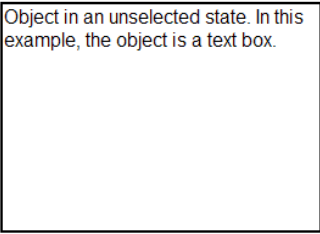
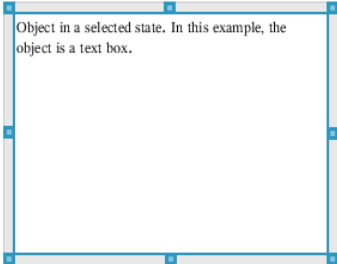
State	Description
Unselected	<p>When unselected, an object does not have handles for repositioning and sizing. To deselect an object, left-click or right-click outside the object.</p> <p>In this example, borders around the object are showing.</p> 
Selected	<p>When selected, an object will have eight square handles framing the object. To select an object, click the object's border. When selected, objects can be moved and resized.</p> <ul style="list-style-type: none"><li>• To move an object, click a border and drag the object to its new location.</li><li>• To resize an object, grab a handle.</li><li>• Right-click the border to open a context menu with options for manipulating the object.</li></ul> 

---

State	Description
-------	-------------

---

**Interactive** An interactive state is indicated by a blue frame around the object. To enter interactive state, left-click or right-click anywhere in the body of the object. When in an interactive state, you can work with the contents of the object. For example, you can add or edit text in a text box or complete math functions in a TI-Nspire™ application. When in an interactive state, context menus contain options specific to the contents of an object.

---

A	B	C_L_n	D_L_u
=seq(i,1,0)			
1 u0	1	0	1.
2		1	0.540302
3 n_max	30	2	0.857553
4		3	0.65429
5		4	0.79348
6		5	0.701369
7		6	0.76396

## Inserting an Object

1. In the Documents Toolbox, ensure the PublishView™ Objects menu is open.

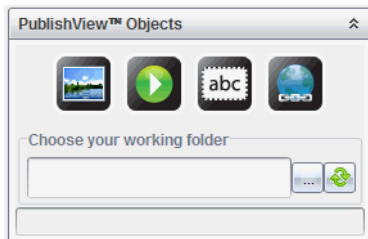

2. Use your mouse to click an icon and drag it to the document.
3. Release the mouse button to drop the object into the document.

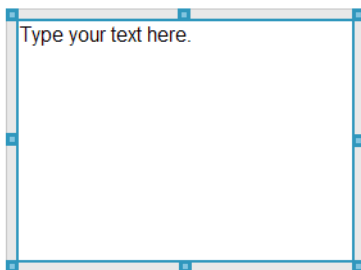

Selected text boxes and frames can be resized, moved, copied, pasted, and deleted.

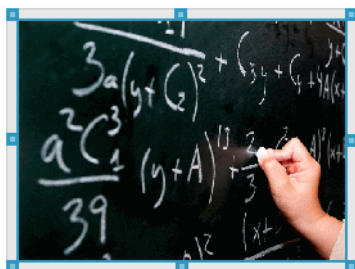

- Using the mouse, grab the handles to resize the object and drag it to position the object in the document as needed.

### Opening Object Context Menus

- Right-click the border of any object in a PublishView™ document.

The context menu opens to provide access to delete, copy/paste, cut, and bring to front/send to back actions.

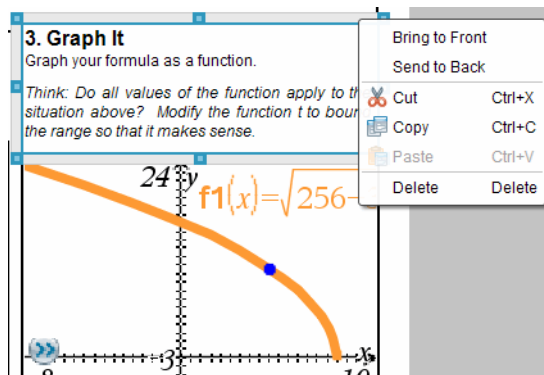



## Resizing an Object

1. Click any border around the object to select it. The border becomes a bold blue line and the handles are active.
2. Move your mouse over one of the handles to activate the resizing tool.



3. Grab one of the handles and drag in the direction needed to make the object larger or smaller.
4. Click outside the object to save the new size.

## Moving an Object

To move an object to another location on the page:

1. Click any border around the object to select it. The border becomes a bold blue line and the handles are active.
2. Move your cursor over one of the borders to activate the positioning tool.



3. Click to grab the object. The horizontal and vertical alignment guides are activated at the top and bottom of the object. Use the grid lines to position the object on the page.

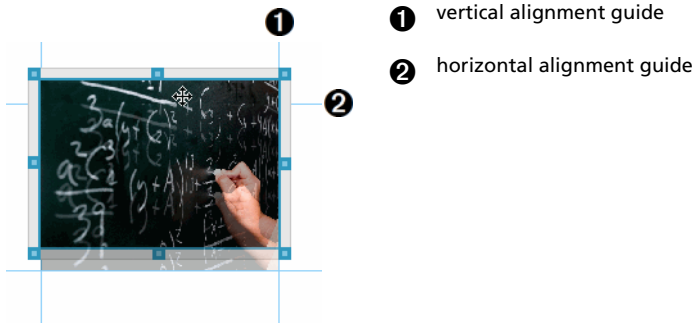

4. Drag the object to a new location on the page.
5. Release the mouse button to drop the object in its new location.

## Overlapping Objects

You can position objects so that one is on top of another. You can control the stacking order to specify which object is positioned in front or behind the other. Overlapping objects have many practical uses when presenting information in the classroom. For example, you can create a "curtain control" by placing an empty text box over other objects. Then, you can move the text box to reveal the items below it one at a time.

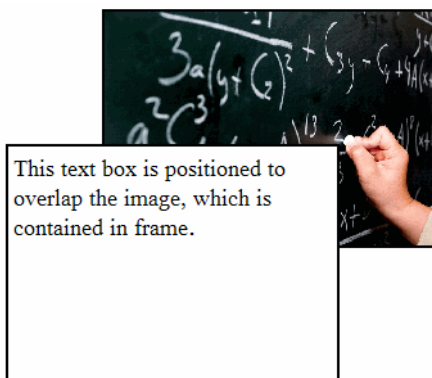

To change the position of an object in the stacking order:

1. Click the border of the object you want to position to select it, and then right-click to open the context menu.

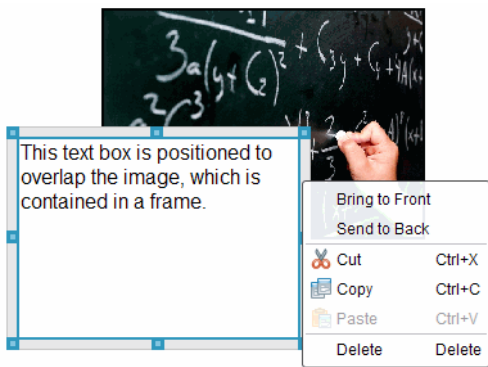

2. Click **Send to back** or **Bring to front** to move the selected object to the desired position.

## Deleting an Object

To delete an object from a sheet:

1. Click any border of the object to select it. When an object is selected, the border is blue and the handles are active.
2. Press the **Delete** key to delete the text box.

—or—

Right-click a border, and then click **Delete** from the context menu.

## Choosing a Working Folder for PublishView™ Objects

Use the Choose Your Working Folder field in the PublishView™ Objects pane to select a folder for storing PublishView™ documents and related files.

1. Ensure the PublishView™ Objects pane is open.

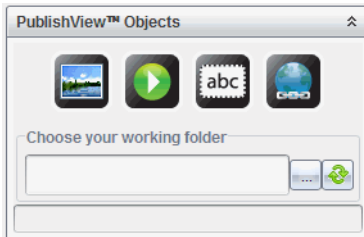

2. Click .

The Choose Your Working Folder dialog box opens.

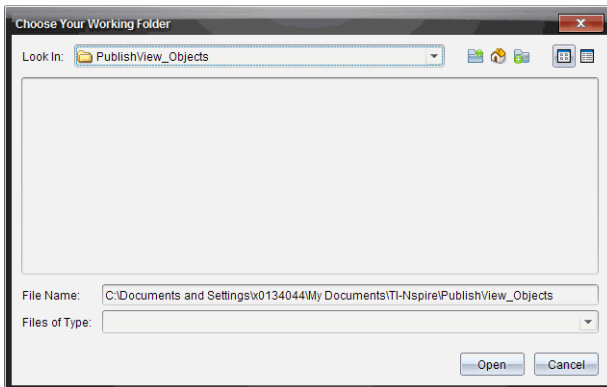

3. Navigate to the folder where you want to store video and image files.

4. Click **Open** to choose the working folder.

The selected folder becomes the working folder and the folder name is displayed in the **Choose your working folder** field. Previews of supported images and video files in the folder are shown in the PublishView™ objects pane.

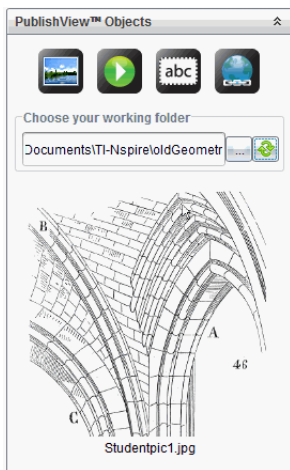

5. To add an image or video file to a PublishView™ document, select the file and move it onto the active sheet.

## ***Working with TI-Nspire™ Applications***

**Note:** For more information, see the appropriate chapter in this guidebook.

### **Adding an Application to a Problem**

To add a TI-Nspire™ application to a problem in a PublishView™ document:

1. Choose one of the following actions to select an application:
  - From the TI-Nspire™ Applications pane in the Documents Toolbox, use the mouse pointer to point to the application and drag it to the problem.
  - From the menu bar, click **Insert** and choose an application from the drop-down menu.
  - Right-click inside the sheet to open the context menu, click **Insert** and choose an application from the menu.

The application is added to the sheet.

### Lists & Spreadsheet Problem

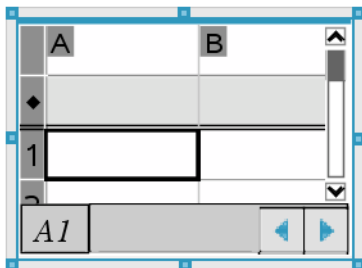

2. Using your mouse, grab the handles to resize or position the application object as needed.
3. Click outside the application frame to accept the dimensions.
4. To open the menu for the active TI-Nspire™ application, click inside the application.

The menu opens in the Documents Toolbox above the TI-Nspire™ Applications pane.

Right-click on an application element, such as a cell or function to open the context menu for that item.

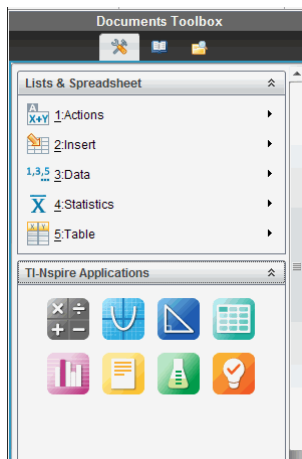

5. To work in the application, click an option from the application menu. Click  to collapse the application menu pane.

## Adding Existing TI-Nspire™ Documents

Use the TI-Nspire™ Documents pane to open an existing TI-Nspire™ document to add to a PublishView™ document. When you open an existing TI-Nspire™ document, all pages of the document appear in the preview pane. You can move complete problems or individual pages onto the PublishView™ sheet.

### Choosing a Working TI-Nspire™ Document

To choose a working document:

1. In the Documents Toolbox, ensure the TI-Nspire™ Documents pane is open.

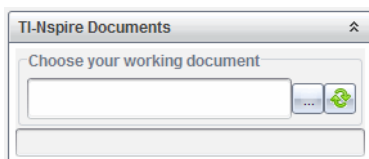

2. Click .



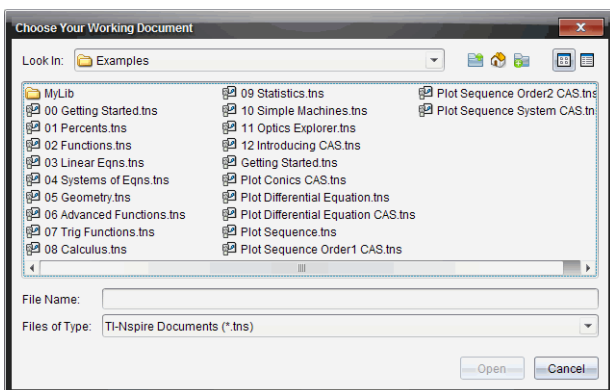

The **Choose Your Working Document** dialog box opens.



3. Navigate to the folder in which the TI-Nspire™ document is stored:

- Click ▼ in the **Look in:** field to use a file browser to locate a folder.

- From an open folder, click  to move up a level in the folder hierarchy

- Click  to return to the default home folder
  - Click  to add a new folder to open folder on your computer.
  - Click  to list folders and files. To show details, click .
4. Select the file, and then click **Open**.

The TI-Nspire™ document opens in the TI-Nspire™ Documents pane.

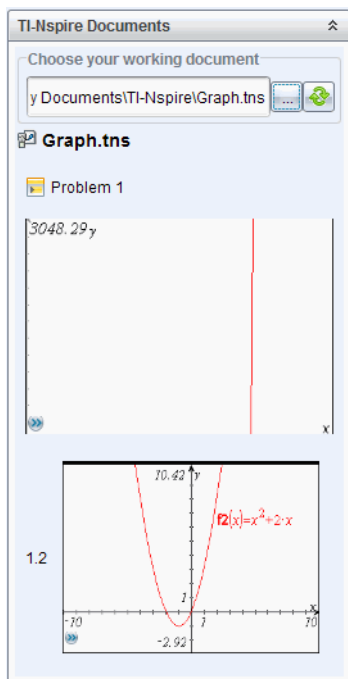

5. To add the TI-Nspire™ document to the PublishView™ document, move one page at a time or one problem at a time to the PublishView™ sheet.

If you are adding a problem with multiple pages, the pages are stacked on top of each other on the PublishView™ sheet. Move the top page to see the other pages.

## Working with Problems

Like a TI-Nspire™ document, a PublishView™ document consists of one or more problems.

Problems are used to control the layout of a PublishView™ document so that you can isolate variables. When variables with the same name are used in multiple problems, variables can have different values. To add problems to PublishView™ documents, open the Sheet context menu or use the options on the Insert menu in the Documents Workspace. When adding problems, keep the following guidelines in mind:

- By default, a new PublishView™ document contains one problem.
- You can insert a problem after any existing problem.
- You cannot insert a problem in the middle of an existing problem.
- A new problem break is always inserted after the selected problem.
- Inserting a problem break adds empty space below the break.
- Any object between two problem breaks is part of the problem above the break.
- The last problem includes all sheets and objects below the last problem break.
- Problem breaks are not relative to any object, which lets you move objects within a problem without affecting the problem break location.

### Adding a Problem

To add a problem to an open PublishView™ document:

1. Right-click anywhere on the sheet, and then click **Insert > Problem**.

The problem is added to the document below any existing problems. The problem break provides a visible divider between problems.



2. To name the problem, highlight the default text, type a name, and then click outside the text box to save the name.

The problem break is saved.



If a document has multiple problems, use the scroll bar on the right side of the document to move up and down through the problems.



## Managing Problem Breaks

Problem breaks are used to separate problems and variable sets.

- Every problem has a problem break.
- A problem break becomes visible when a problem is added to a document.
- A problem break is represented by a dashed line with the name of the problem positioned on the left side of the sheet.
- By default, the problem name is shown as **<Name of problem>**. Highlight the default text to type a new name for the problem.
- Problem names do not have to be unique. Two problems can have the same name.

## Hiding and Showing Problem Breaks

You can select to hide or show problem breaks in a PublishView™ document. By default, problem breaks are shown.

1. Right-click in any blank area of the document (outside of any object) to open the sheet context menu.
2. Click **Layout Options**.

The Show/Hide Options dialog box opens.

**Note:** You can also click **View > PublishView™ Layout Options**.

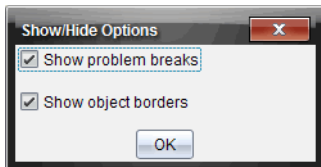

3. Clear the **Show problem breaks** option to hide problem breaks in the document. Select the option to return to the default setting and show the problem breaks.
4. Click **OK** to close the dialog box.

## Renaming a Problem

1. Click the existing problem name on the problem break line.
2. Type a new name for the problem.
3. Click outside the text box to save the new name.

## Deleting a Problem

To delete a problem, complete one of the following actions:

- ▶ Select the problem break and click **X** on the right side of the break.
- ▶ Click **Edit > Delete**.
- ▶ Right-click the problem break and click **Delete**.
- ▶ Select the problem break and press the **Delete** or **Backspace** key.

When you delete a problem, all objects contained in the problem are removed and the space between the selected problem break and the next problem break is removed.

## Organizing PublishView™ Sheets

A PublishView™ document can have multiple sheets. A single sheet is displayed in the workspace on your screen. All work occurs in the PublishView™ objects and TI-Nspire™ applications within sheets.

### Adding Sheets to a Document

To add a sheet to a document:

- ▶ Click **Insert > Sheet**.

The sheet is added to the document and the numbering increments by one.

### Opening the Sheet Context Menu

- ▶ Right-click in any blank area (outside of any object) in a PublishView™ sheet.

A context menu opens with options for inserting problems, pages, applications, and PublishView™ objects, edit options for removing space or deleting a page, and options for hiding and showing problem breaks and object borders.

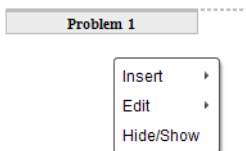

## Page Numbering

In a PublishView™ document, page numbering is displayed in the bottom margin (footer). By default, numbering is placed in the center of the PublishView™ sheet in a # of # format. You cannot edit or delete page numbering.

## Working with Headers and Footers

PublishView™ documents contain space at the top and bottom of a sheet to add a header or a footer. Headers and footers can contain the date, the document name, the lesson plan name, the class name, your school's name, or any other information needed to identify a document.

By default, headers and footers do not contain content and boundaries for the header and footer are hidden. To activate a header or footer for editing, click inside the top or bottom margin. When activated, a text box with a light gray border is displayed.

### Inserting and Editing Text in Headers and Footers

1. Click inside the top or bottom margin.

The text box borders in the margin become visible and the object space is disabled. The cursor is placed in the header or footer space and the formatting toolbar becomes active.

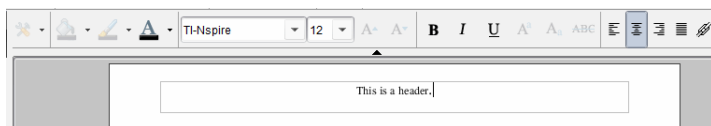

2. Type the text.
  - The default font is TI-Nspire™ true type, 12 pt, normal.
  - By default, text is centered horizontally and vertically.
  - Text can be aligned: left, center, right, or justified.
  - Text that does not fit within the text box horizontally will wrap to the next line.
  - Text that does not fit within the text box vertically will not be shown, but text is retained. (If you delete text, the hidden text will appear.)
3. Complete one of the following actions to save the text:
  - Single-click anywhere outside the header or footer text box to save the text.

- Press **Esc** to save the text.

The PublishView™ sheet becomes active and the formatting menu closes.

## Showing and Hiding Borders

By default, borders are displayed when you insert an object into a problem. When you select to hide borders, the selection applies to all objects in the document and to objects that you add to the document. To hide the border:

1. Right-click in any blank area of the sheet (outside of any object) to open the context menu.
2. Click **Layout Options**.

The Layout Options dialog box opens.

**Note:** You can also click **View > PublishView™ Layout Options**.

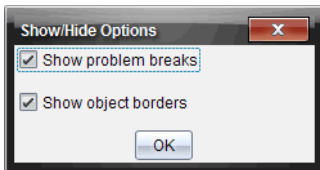

3. Clear the **Show object borders** option to hide the borders around the objects in the problem. Select the option to return to the default setting and show borders.
4. Click **OK** to close the dialog box.

## Adding and Removing Space

To manage how PublishView™ objects appear on a sheet, you may need to add or delete space between objects.

**Note:** You can add and remove vertical space between objects using this method. To add or remove horizontal space between objects, move the object.

### Adding Space

1. Right-click in the area outside of any object where you want to add space. The context menu opens.
2. Click **Edit > Add/Remove Space**. The Add/Remove Space tool becomes active.



Drag up and press enter to remove space

### Add/Remove Space tool

Drag down and press enter to add space



3. Use your mouse to position the tool to the exact place where you want to add space.
4. Click the tool, and then drag **down** to select the amount of space you want to add. As you select the amount of space to be added, it is indicated in green.

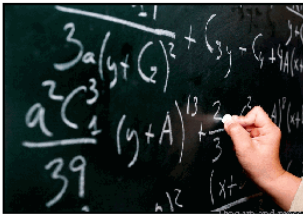

Drag up and press enter to remove space

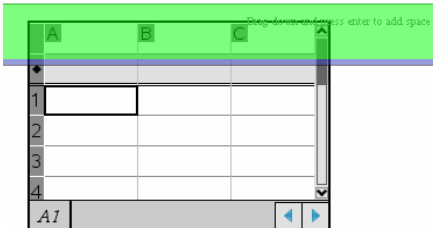

Drag down and press enter to add space

5. Press the **Enter** key to add the space in between the objects. You can adjust the amount of space by dragging up and down before you press **Enter**.

### **Removing Space**

1. Right-click in the area outside of any object where you want to remove space.

The context menu opens.

2. Click **Edit > Add/Remove Space**.

The Add/Remove Space tool becomes active.

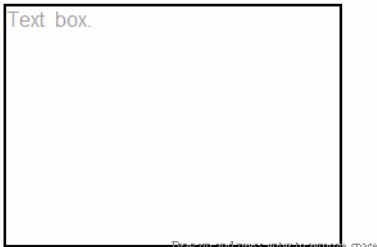

Drag up and press enter to remove space

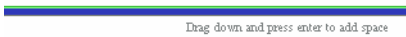

Drag down and press enter to add space

Add/Remove  
Space tool



3. Use your mouse to position the tool to the exact place where you want to remove space.
4. Click the tool, and then drag **up** to select the amount of space you want to remove. As you select the amount of space to be removed, it is indicated in red.

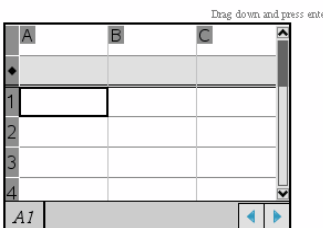
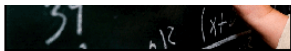

5. Press the **Enter** key to remove the space in between the objects. You can adjust the amount of space by dragging up and down before you press **Enter**.

**Note:** If there is not enough space on the sheet to accommodate the objects, the objects won't be moved when space is removed.

## Deleting Blank Sheets from Problems

You can delete a sheet that does not contain any TI-Nspire™ applications or PublishView™ objects from a problem. To delete a blank sheet from a problem:

1. Delete any TI-Nspire™ applications, PublishView™ objects, move or delete any problem breaks from the sheet.
2. Place your cursor inside the sheet you want to delete.
3. Right-click inside the blank sheet to open the context menu.
4. Click **Edit > Delete Sheet**.

The blank sheet is removed from the problem.

## Using Zoom

The zoom feature lets you zoom in on any object or area on the PublishView™ document for discussion, and zoom out to see an overview of the lesson. The zoom uses the center point of the viewable area to zoom in.

The default zoom setting is 100%.

- ▶ To change the zoom percentage, do one of the following:
  - Type the number in the box and press **Enter**.

- Use the - and + buttons to decrease or increase the percentage in 10% increments.
- Use the drop-down arrow to choose a preset percentage.

The zoom settings are retained when you save the document.

## **Adding Text to a PublishView™ Document**

In a PublishView™ document, there are three ways to add text:

- Insert a PublishView™ text box to enter free-form text or copy text from other sources into the document. For example, you can place a PublishView™ text box next to an image and type a description in a text box. You can also copy and paste text from .doc, .txt, and .rtf files. Use PublishView™ text boxes when you need options for emphasizing and formatting text. PublishView™ text boxes are not converted when you convert a PublishView™ document to a TI-Nspire™ document. You may want to use a PublishView™ text box to add text that you don't want handheld users to see.
- Use the TI-Nspire™ Notes application. You should use the Notes application when you need an advanced equation editor and when you need to use TI-Nspire™ math templates and symbols. Superscript and subscript are also easier to use in the Notes application. You should also use Notes when you are planning to convert the PublishView™ document to a TI-Nspire™ document for use on a handheld and you want handheld users to see the text.
- Add text in TI-Nspire™ applications that allow text just as you would in a TI-Nspire™ document.

### **Inserting Text into a Text Box**

1. Ensure the PublishView™ Objects pane is open.

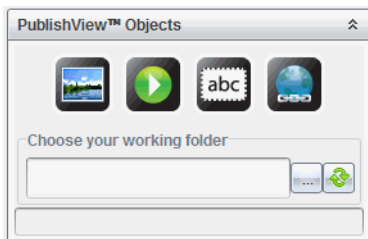

2. Use your mouse to click  and drag it to the problem.
3. Release the mouse button to drop the text box into the problem.



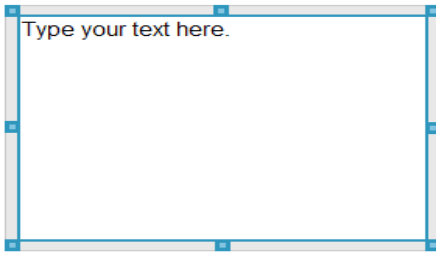

4. Using the mouse, grab the handles to resize the text box or position in the problem as needed.
5. Click outside the text box to save the size and position.
6. Click "Type your text here."

The formatting toolbar becomes active. The text box is in an interactive state for adding or editing text.

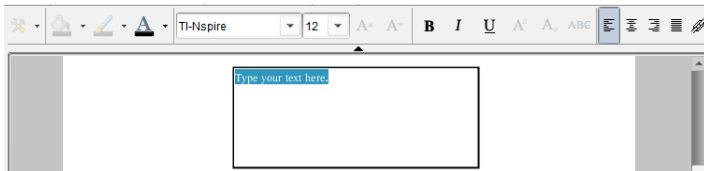

7. Type the new text.  
—or—  
Copy and paste text from another file.
8. Apply formatting as needed.
9. Click outside the text box to save the text.

## Formatting and Editing Text

The options for editing and formatting text are located on a formatting toolbar at the top of the active document. Formatting options for editing text include:

- Changing the font, font size, and font color.
- Applying bold, italics, and underline formatting.
- Applying the following text horizontal alignment options: left, right, centered, and justified.
- Inserting hyperlinks.

## Launching Edit Mode

- ▶ Click inside a text box to launch edit mode.
  - The formatting menu opens.
  - The text is selectable for editing.

## Opening the Content Context Menu

- ▶ Right-click inside a text box containing text or a hyperlink.

The formatting menu and context menu open providing shortcuts to cut, copy, and paste.

## Using Hyperlinks in PublishView™ Documents

In PublishView™ documents, use hyperlinks to:

- Link to a file
- Link to a website on the Internet

You can add a hyperlink to an open document or you can convert any text within a text box to a hyperlink. When a hyperlink is added, the formatting of the text is underlined and the font color is blue. You can change the formatting of the hyperlinked text without losing the hyperlink.

If a link is broken, an error message is displayed when you click the link:

- Cannot open the specified file
- Cannot open the specified web page

PublishView™ text boxes support both absolute and relative links.

Absolute links contain the complete location of the linked file and do not depend on the location of the main document.

Relative links contain the location of the linked file relative to the main document. If you have multiple lessons in a single folder and they are all linked using relative addressing, you can move the folder to any other location (another local folder, datashare, flash drive, online) without breaking the links. The links also stay intact if you bundle the documents into a lesson bundle or zip them into a zip file and share them.

**Note:** The PublishView™ document must be saved before you can insert a relative hyperlink.

## Linking to a File

You can link to any file on your computer. If the file type is associated with an application on your computer, it will launch when you click the link. There are two ways to link to a file; by typing or pasting a file address into the Address field, or by browsing to a file.

### Linking to a File by Using an Address

1. Ensure the PublishView™ Objects pane is open.

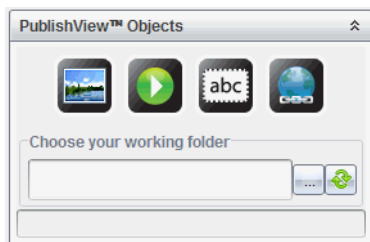

2. Drag the hyperlink icon  onto the document.

The Hyperlink dialog box opens.

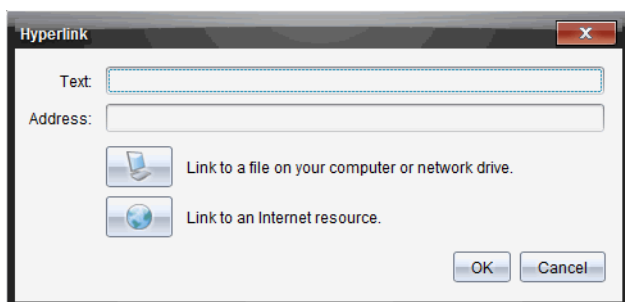

3. Type the name of the link in the Text field. For example, this can be the name of the document.
4. Copy the location of the file path you want to link to, and paste it in the Address field.

—or—

Type the location of the file in the Address field.

**Note:** Type `../` to designate parent directories. For example:  
`../../lessons/mathlesson2.tns`

5. Click **OK** to insert the link.

A text box containing the hyperlink is added to the PublishView™ document.

### **Linking to a File by Browsing**

1. Ensure the PublishView™ Objects pane is open.

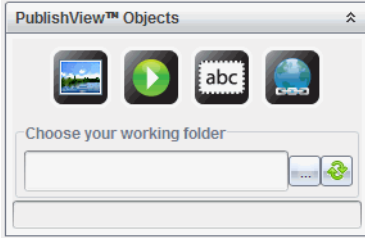

2. Drag the hyperlink icon  onto the document.

The Hyperlink dialog box opens.

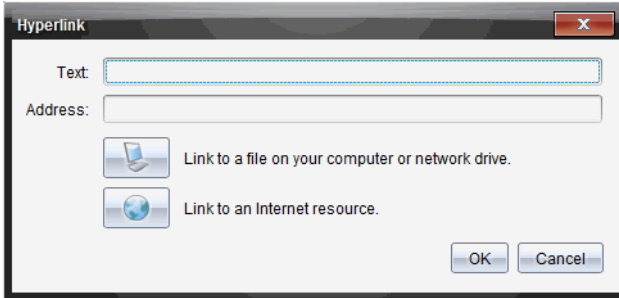

3. Type the name of the link in the Text field. For example, this can be the name of the document.
4. Click  to select **Link to a file on your computer or network drive**.

The **Select file to insert as hyperlink** dialog box opens.

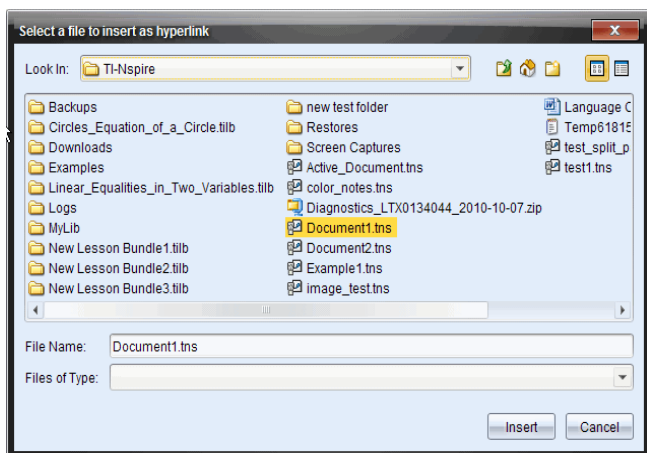

5. Navigate to and select the file you want to link to, and then click **Insert**.

The path name is inserted into the Address field in the Hyperlink dialog box.

If the software is unable to determine if the link is a relative or absolute address, the Hyperlink dialog box opens with an option to change the type of link.

To change the link, click the appropriate option:

- **Change to absolute address.**
- **Change to relative address.**

6. Click **OK** to insert the link.

—or—

Click **Start Over** to go back to the Hyperlink dialog box and choose a different file to link, or to edit the Text or Address fields.

A text box containing the hyperlink is added to the PublishView™ document.

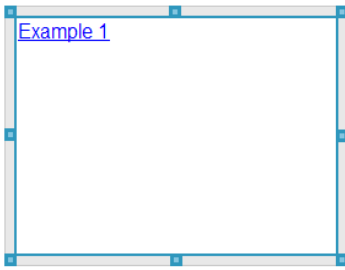

7. Using the mouse, grab the handles to resize the text box.

—or—

Grab any border to position the text box in the document as needed.

## Linking to a Website



There are two ways to link to a website; by typing or pasting the URL into the Address field, or by browsing to a file.

### ***Linking to a Website by Using an Address***

1. Ensure the PublishView™ Objects menu is open.
2. Drag the hyperlink icon  onto the document to open the Hyperlink dialog box.
3. Type or paste the URL you want to link to in the Address field.
4. Click **OK**.

A text box containing the hyperlink is added to the PublishView™ document.

### ***Linking to a Website by Browsing***

1. Ensure the PublishView™ Objects menu is open.
2. Drag the hyperlink icon  onto the document to open the Hyperlink dialog box.
3. Click  to select **Link to an Internet resource**.  
The browser opens to your default website.
4. Navigate to the website or file on a website that you want to link to.

- Copy the URL, and then paste it in the Address field in the Hyperlink dialog box.

—or—

Type the URL in the Address field.

- Click **OK**.

A text box containing the hyperlink is added to the PublishView™ document.

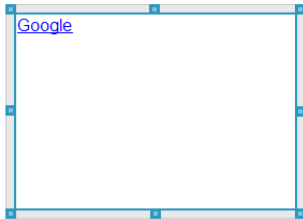

- Using the mouse, grab the handles to resize the text box.

—or—

Grab any border to position the text box in the document as needed.

## Editing a Hyperlink

To change the name of a hyperlink, change the path, or change the URL, complete the following steps.

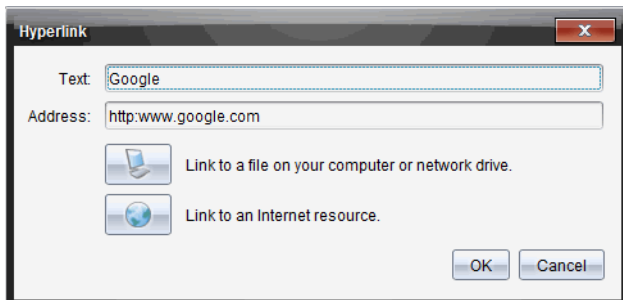

- Using your mouse, right-click the hyperlink text, and then click **Edit hyperlink**.

The Hyperlink dialog box opens.



- Make corrections as needed:

- Type corrections to the hyperlink name in the **Text** field.

- Click  to open the **Select a file to add as a hyperlink** dialog box and use the file browser to navigate to the folder where the file is located.
- Click  to open a browser and navigate to a website to copy and paste the correct the URL in the **Address** field.

3. Click **OK** to save the changes.

## Converting Existing Text to a Hyperlink

1. Click inside the text box to activate edit mode and open the formatting menu.
2. Select the text you want to convert to a hyperlink.

3. Click .

The Hyperlink dialog box opens with the selected text in the Text field.

4. Click  to create a link to a file.

—or—

Click  to create a link to page on a website.

## Removing a Hyperlink

Use this process to remove a link from text inside a text box. The text remains in the document.

1. Using your mouse, right-click the hyperlink text.
2. Click **Remove hyperlink**.

The hyperlink formatting is removed from the text and the text is no longer clickable.

**Note:** To remove both the text and hyperlink, delete the text. If a text box contains only the linked text, delete the text box.

## Working with Images

Images can be added to PublishView™ documents as PublishView™ objects or can be added inside TI-Nspire™ applications that support images. Supported files types are .bmp, .jpg, and .png files.



**Note:** If a TI-Nspire™ application is active in the PublishView™ document, the image is added to the TI-Nspire™ page if you click **Insert > Image** from the menu bar or context menu. If there is no TI-Nspire™ document active, the image is added as a PublishView™ object. Only images inside TI-Nspire™ applications convert to TI-Nspire™ documents (.tns files).

## Inserting an Image

1. Ensure the PublishView™ Objects pane is open.

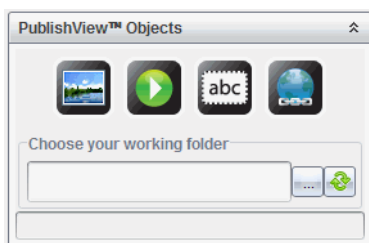

2. Click , and then drag the icon to the document.

The **Choose an image to insert into PublishView™** dialog box opens.

**Note:** By default, the Texas Instruments preloaded images folder is displayed.

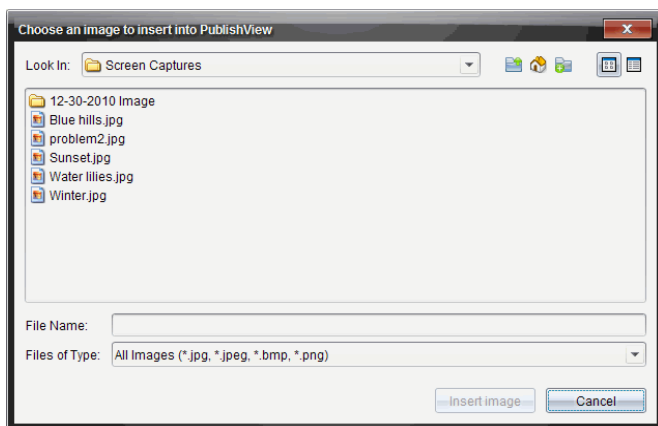

3. Navigate to the folder where the image file you want to insert is located, and then highlight the file name.
4. Click **Insert image**.

The image is added to the PublishView™ sheet.

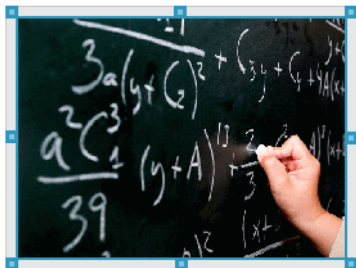

- Using the mouse, grab the handles to resize the text box,  
—or—  
Grab any border to position the text box in the document as needed.

### Moving Images

- Click the frame containing the image to select it.
- Move your cursor over the edge of the image to activate the positioning tool.
- Move the image to its new location on the PublishView™ sheet.

**Note:** Objects can overlap each other on a PublishView™ sheet.

### Resizing Images

- Click the frame containing the image to select it.
- Move your cursor over one of the blue handles to activate the resizing tool.
- Drag the handle to make the image smaller or bigger.

### Deleting Images

- Click the image to select it, and then press the **Delete** key.  
—or—
- Right-click a handle to open the context menu, and then click **Delete**.

### Working with Video Files

You can embed a Flash (.flv) video file in a PublishView™ document and play the video directly from the PublishView™ document.

**Note:** You can also insert a link to a video that will launch in a new browser window or media player window. For more information, see *Working with Hyperlinks*.

## Inserting a Video

1. Ensure the PublishView™ Objects pane is open.

2. Click , and then drag the icon to the document.

The **Choose a video to insert into PublishView™** dialog box opens.

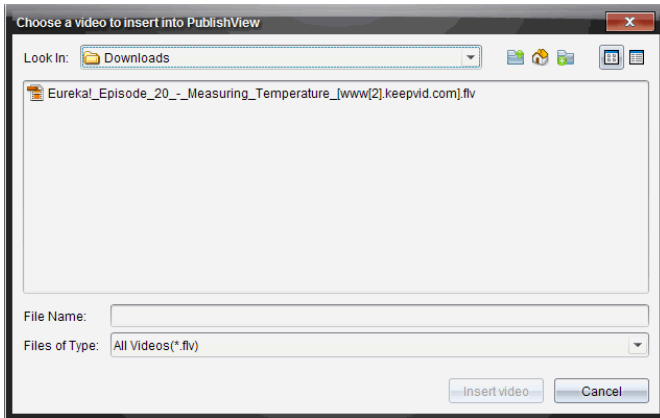

3. Navigate to the folder where the video file you want to insert is located, and then highlight the file name.
4. Click **Insert video**.

An object containing the embedded video is added to the PublishView™ sheet. By default, the resizing and positioning handles are active.





- Using the mouse, grab the handles to resize the object or grab any border to position the object in the document as needed. For example, you may want to position the object containing the video above or below a text box that contains text introducing the video.
- To play the video, click the forward arrow, or click anywhere in the viewing window.

## Using the Video Console

The video console enables users to control when to start and stop the video.



The console contains the following controls:

- Click  to start the video. When playing, click  to stop the video.
- As the video plays, the time elapsed is shown in minutes and seconds.
- When the video starts, the length of the video is shown in minutes and seconds.
- Use the volume control to increase, decrease, mute, or unmute the volume.

## Converting Documents

You can convert PublishView™ documents (.tnsp files) to TI-Nspire™ documents (.tns files) for display on handhelds. You can also convert TI-Nspire™ documents to PublishView™ documents.

Converting a document creates a new document—the original document remains intact and is not linked to the new document. If you make changes to one document, the changes are not reflected in the other document.

## Converting PublishView™ Documents to TI-Nspire™ Documents

You cannot open a PublishView™ document (.tnsp file) on a handheld. However, you can convert the PublishView™ document to a TI-Nspire™ document that can be transferred to and opened on a handheld. When you convert a PublishView™ document to a TI-Nspire™ document:

- Only the TI-Nspire™ applications become part of the TI-Nspire™ document.
- PublishView™ objects such as text boxes, images, hyperlinks, and videos are not converted.
- Text contained in PublishView™ text boxes is not converted; however, text in a TI-Nspire™ Notes application is converted.
- If images are contained in a TI-Nspire™ application, they are converted; however, images contained in PublishView™ objects are not converted.

Complete the following steps to convert a PublishView™ document (.tnsp file) to a TI-Nspire™ document (.tns file).

1. Open the PublishView™ document to be converted.
2. Click **File > Convert to > TI-Nspire™ Document**.
  - The new TI-Nspire™ document opens in the Documents Workspace.
  - All supported TI-Nspire™ applications are part of the new TI-Nspire™ document.
  - Starting from top to bottom, and then left to right, the layout of the TI-Nspire™ document is based on the order of the TI-Nspire™ applications in the PublishView™ document.
    - Every TI-Nspire™ application in a PublishView™ document will appear as a page in the converted TI-Nspire™ document. The order of the pages in the TI-Nspire™ document is based on the layout of the TI-Nspire™ applications in the PublishView™ document.
    - If two or more problems are at the same level, the order is left to right.
  - Problem breaks are maintained.
  - The new TI-Nspire™ document is not linked to the PublishView™ document.

3. When work in the document is complete, click  to save the document in the current folder.

—or—

Click **File > Save As** to save the document in a different folder.

**Note:** If the document has never been saved, both the **Save** and **Save as** options allow saving in a different folder.

**Note:** You can also use the **Save as** option to convert a PublishView™ document to a TI-Nspire™ document.

**Note:** If you try to convert a PublishView™ document that does not contain TI-Nspire™ pages or applications, an error message is displayed.

## Converting TI-Nspire™ Documents to PublishView™ Documents

You can convert existing TI-Nspire™ documents to PublishView™ documents, which enables you to take advantage of the richer layout and editing features for printing, generating student reports, creating worksheets and assessments, and publishing documents to a website or blog.

Complete the following steps to convert a TI-Nspire™ document to a PublishView™ document:

1. Open the TI-Nspire™ document you want to convert.
2. Click **File > Convert to > PublishView™ Document**.
  - The new PublishView™ document opens in the Documents Workspace.
  - By default, there are six objects per page.
  - When converted, each problem from the TI-Nspire™ document will start a new sheet in the PublishView™ document.
  - Problem breaks are maintained.
3. When work in the document is complete, click  to save the document in the current folder.

—or—

Click **File > Save As** to save the document in a different folder.

**Note:** You can also use the **Save as** option to save a TI-Nspire™ document as a PublishView™ document.

## Printing PublishView™ Documents

You can print reports, worksheets, and assessments created using the PublishView™ feature. To print a document:

1. Click **File > Print**.

The Print dialog box opens. A preview of the document is shown on the right side of the dialog box.

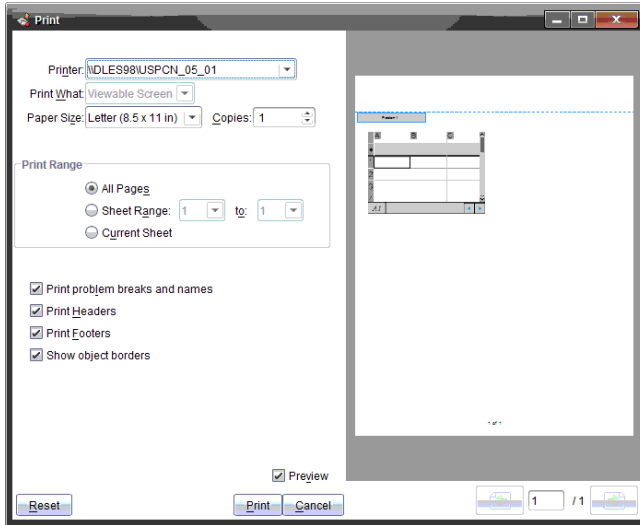

2. Select a printer from the menu.  
**Note:** The **Print what** field is disabled.
3. Select **Paper Size** from the menu. Options are:
  - Letter (8.5 x 11 inches)
  - Legal (8.5 x 14 inches)
  - A4 (210 x 297 mm)
4. Select the number of **Copies** you want to print.
5. In the **Print Range** area, select to print all pages in the document, a range of pages, or the current page only.

**Note:** By default, top and bottom margins are set to one-inch and are maintained when printing a PublishView™ document. There are no side margins. PublishView™ sheets print just as they appear in the workspace.

6. If needed, select or clear the boxes to:

- Print Problem Breaks and Names.
  - Print Headers
  - Print Footers
  - Show object borders
7. Click **Print**.



# Using the Review Workspace

Use this workspace to review a collected set of documents, manage student responses, run live activities, and organize data.

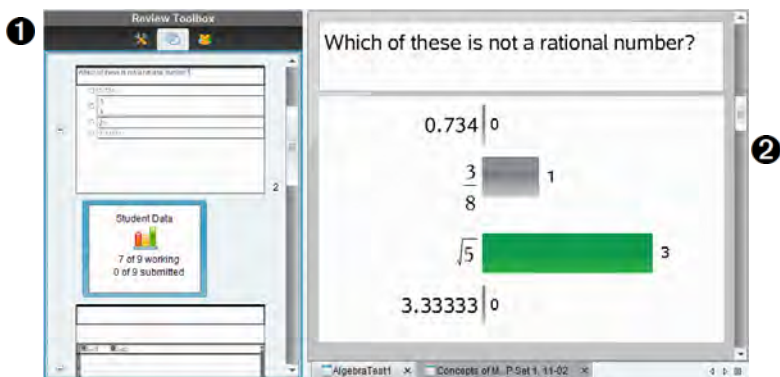



- 1 Review toolbox.** Contains the Review Tools, Page Sorter, and Student Response tools. Click each icon to access the available tools. Options for the selected tool are displayed in the toolbox pane.
- 2 Data View pane.** Shows the data and options from the poll or document you have selected in the Review Toolbox. You can switch the data view between bar chart, table, and graph (if available).  
The software retains the data view that was set for each question when you close and reopen the Review Workspace. All hidden and unhidden data, settings in graph view, table view, bar chart view, and Show Your Work are retained when you close the Review Workspace.

## Using the Review Toolbox

The Review toolbox contains tools needed for working with collected documents, Question results, and Quick Poll results.

Icon	What you can do
 <b>Review tools</b>	The Review tools let you organize the response data, use graph tools, hide or show responses, and mark Question and Quick Poll responses as correct or incorrect.

Icon	What you can do
 <b>Page sorter</b>	Displays all the problems in a document or Quick Poll, all the pages in each problem, and the student responses for each question in the document.
 <b>Student pane</b>	Displays the student names and responses in the Data View pane.

## Exploring the Review Tools

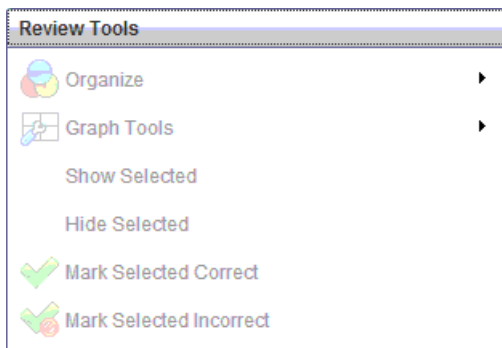

- 1 **Organize.** Click ► to organize the data in different views.
- 2 **Graph Tools.** Click ► to access the graph tools when you are in coordinate graph view.
- 3 **Show Selected.** Shows selected responses for review in the Data View pane.
- 4 **Hide Selected.** Hides selected responses in the Data View pane.
- 5 **Mark Selected Correct.** Select a response from the Data View pane and click **Mark Selected Correct** to mark that response as the correct answer. You can mark more than one answer as a correct answer.
- 6 **Mark Selected Incorrect.** Select a response from the Data View pane and click **Mark Selected Incorrect** to mark that response as an incorrect answer. You can mark more than one answer as an incorrect answer.

## Exploring the Page Sorter

Use the Page Sorter to view student responses to any question in a document.

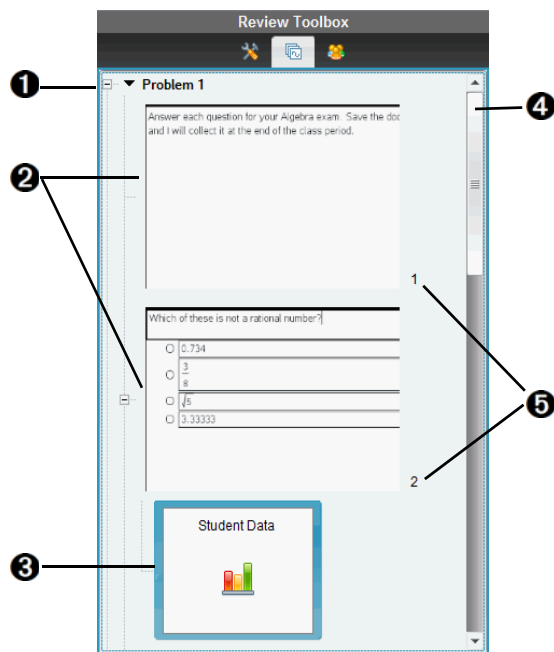

- 1 Click the minus sign (-) to collapse the view. Click the plus sign (+) to expand the view and show all the pages in a problem, and all the problems in a document.
- 2 The pages in a problem. Click a page to open it in the Data View pane.

- ③ **Student responses.** A student data icon follows each question in the document. Click the icon to view the student responses for the question in the Data View pane.

In Quick Polls, the icon shows the number of students who were logged in when the poll was started, the number who have responded, and the number who have submitted their answer. In the example below, nine students received the poll, seven students responded to the poll, and no students have submitted their answer.

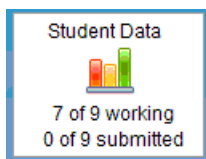

**Note:** If you send a poll to students who were missing, the numbers may change.

- ④ **Scroll bar.** The scroll bar is active when there are too many pages to show in the panel.
- ⑤ **Page numbers.** Click a page number to open the page in the Data View pane.

## Exploring the Student Pane

Use the Student pane to:

- Display the students to whom the file was sent
- View the students who responded
- View student responses
- Mark responses as correct or incorrect
- Sort the responses by student or response, or by time in Quick Polls

Review Toolbox

1  Display Student Responses 5

2

Student	Response	Time
<input checked="" type="checkbox"/> Baker, Susan	$\sqrt{5}$	11:50:18
<input checked="" type="checkbox"/> Chopra, Laxmi	0.734	11:50:14
<input checked="" type="checkbox"/> Huang, Shen	$\sqrt{5}$	11:50:36
<input checked="" type="checkbox"/> Kapur, Samir	$\sqrt{5}$	11:50:05
<input checked="" type="checkbox"/> Li, Song	$\sqrt{5}$	11:50:32
<input checked="" type="checkbox"/> Lopez, Maria		
<input checked="" type="checkbox"/> Moore, Jacob	$\sqrt{5}$	11:50:28
<input checked="" type="checkbox"/> Simmons, Nadine		
<input checked="" type="checkbox"/> Thompson, Olivia	$\frac{3}{8}$	11:50:25

3

4

1 **Display Student Responses.** Select this check box to show the responses of each student. Clear the check box to hide the student responses.

2 **Student, Response, and Time** columns. The Time column is available only in Quick Poll reviews.

- Click the Student column to list the students in alphabetical order. Click again to list in reverse alphabetical order.
- Click the Response column to list the responses in alphabetical or numerical order. Click again to list the responses in reverse order.
- To add the Time column in Quick Poll reviews, click the Options menu , and then click **Time**.
- Click the Time column to list the responses in order of the time they were answered (first response on top). Click again to list the responses with the first response on the bottom.

3 **Student names.** Lists all students in the class associated with the document currently opened for review. The student names are displayed as chosen in the **Class > Student Name Format** menu. Student names in red text indicate students who did not receive the file or respond to the Quick Poll.

**4 Responses.** Lists all responses next to the student's name. A student may be listed several times if they gave multiple responses. The Response column may change if the review document is an active Quick Poll or a question document that has not been saved yet.

- A response is shown if the student responded.
- The response area is blank if the student did not respond.
- "Responded" is displayed if the student responded and the responses are hidden.
- "No Response" is displayed if the student has not yet responded to the open question or active Quick Poll.
- "Working" is displayed if the student has modified their response to a Quick Poll, but has not submitted it.

**5 Options menu.** Click ▼ to open the menu of options you can perform on the student responses:

- Display student responses.
- Display student names only.
- Display responses only.
- Display a Time column for Quick Poll results.
- Select all items in the list.
- Show the selected item.
- Hide the selected item.
- Mark one or more responses as correct.
- Mark one or more responses as incorrect.

## Exploring the Data View Pane

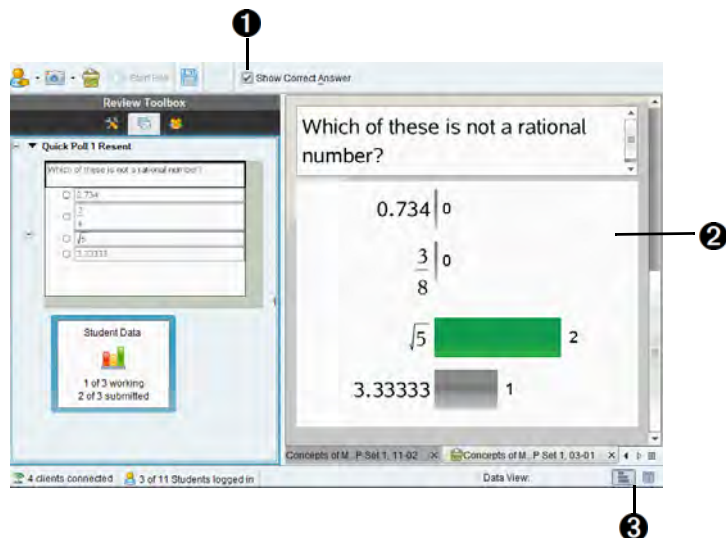

- 1 Show Correct Answer.** Select this check box to display the answer you marked as the correct answer in the Data View pane. The correct answer is highlighted in green.
- 2 Responses.** Shows the information chosen in the Page Sorter. This example shows the responses from a selected Student Response icon. You can show or hide responses, and mark responses as correct or incorrect.
- 3 Data View.** Click an icon to view the data in different formats: bar chart, graph, or table. A "Show Your Work" option is available for expression and equation questions.

## Understanding the Data View

The Data View pane displays the question in the open document, as well as the responses to that question. You can view live results in the Data View pane. The data is updated in real time as students respond to Quick Poll and Open Response questions, graph functions, or move points on a graph.

The Data View icons allow you to view responses in the Data View pane as a bar chart, graph, or table. Each view shows the student responses and the frequency of each response.

The bar chart and table views are available for all question types and Quick Poll documents. The graph view is available in equation, coordinate points, and list questions.

Expression and equation questions have an additional "Show Your Work" data view available, if you marked the question for students to show their work. The "Show Your Work" data view is retained when you close and reopen the Review Workspace.

The following examples show the same data displayed in different data views.

Click  to view the data in bar chart form.

$$y=x+3 \quad \text{3}$$

$$y=x+1 \quad \text{2}$$

$$y=x-3 \quad \text{1}$$

Click  to view the data in graph form.

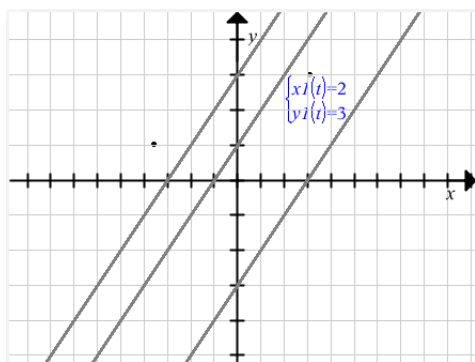

When you are in graph view, the Graph Tools are available to allow you to work with the graph. The settings in the graph are retained when you close and reopen the Review Workspace.



In the bar chart and graph views, hover your mouse pointer over a response to see a list of students who gave that response.

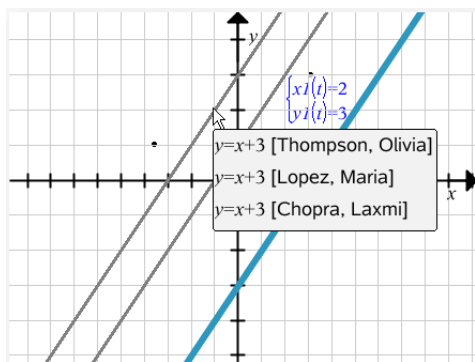
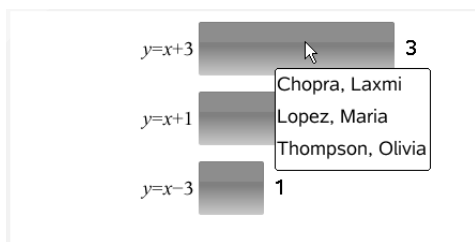

Click  to view the data in table form.

The table view is available as a frequency table or as a student table.

- ▶ To view data in different table views, click the Organize tool in the Review toolbox, and then click **Frequency Table** or **Student Table**.

A frequency table shows the responses with the number of times the response occurred. Click the Response heading to sort the responses in ascending order, descending order, or question order. Click the Frequency heading to sort by frequency of response.

Response	Frequency
$y=3-x$	3
$y=x-3$	1
$y=x+3$	1

A student table shows the student names with their responses. Click the Student heading to sort the responses in ascending or descending alphabetical order. Click the Response heading to sort the responses in ascending order, descending order, or question order.

Student	Response
Chopra, Laxmi	$y=3-x$
Garcia, Rafe	$y=x-3$
Moore, Jacob	$y=x+3$
Ortega, Carlos	$y=3-x$
Simmons, Nadine	$y=3-x$

The settings for sorting and sizing columns are retained for each document when you close and reopen the Review Workspace.

## Opening Documents for Review

You can review a document that has been collected from the class, a Quick Poll in progress, or a saved Quick Poll. You cannot review a document that does not have questions.

When you start a Quick Poll, the software automatically switches to the Review Workspace, and you can review the data as the students are responding. When you stop and save the poll, you can open it in the Review Workspace to review the saved responses.

If this is your first time using the software, the Data View pane may be empty. Complete the following steps to open a document for review.

### Opening a Document from the Class Workspace

To open a document for review from the Class Workspace:

1. Use the Workspace selector to select the Class Workspace.
2. Right-click a file from the Class Record, and then click **Open in Review workspace**.

The software automatically switches to the Review Workspace with the selected document open.

**Note:** You can open collected documents  that contain questions

and Quick Polls  for review in the Class Record.

Class Record		
Action	File Name	Status
	AlgebraTest1	0 of 10
	AlgebraTest1.tns	0 of 10
	AlgebraTest2.tns	0 of 10
	AlgebraTest1	6 of 10
	Unprompted-12-01	(1)
	AlgebraTest1.tns	7 of 10
	Plot Differential Equation	0 of 1
	Plot Differential Equation.tns	6 of 10
	Poll 1.tns	4 of 9
	Poll 6.tns	1 of 9
	Poll 5.tns	1 of 9
	ICECreamConeDocument.t...	2 of 10
	02 Functions	0 of 4
	Homework2.tns	0 of 9
	Homework2.tns	0 of 9
	00 Getting Started.tns	0 of 9
	Homework2.tns	0 of 9
	Mixed Files	3 of 3
	Mixed Files	3 of 3
	Poll 4.tns	3 of 11
	Unprompted-11-18	(4)
	10 Simple Machines	0 of 4
	05 Geometry	0 of 1

## Opening a Document from the Portfolio Workspace

To open a document for review from the Portfolio Workspace, follow these steps:

1. Use the Workspace selector to select the Portfolio Workspace.
2. Right-click a column cell or a cell in a student row, and then click **Open in Review workspace**.

Assignment Summary	02 Functions	03 Linear Equis	Algebra Test2	Average
Column Actions				
Class Average	---	---	0%	0%
Date	12-08	12-08	12-08	
Baker, Susan				
Chopra, Laxmi			0%	0%
Garcia, Rafe			0%	0%
Huang, Shen			0%	0%
Kapur, Samir				
Li, Song				
Lopez, Maria				
Moore, Jacob				
Ortega, Carlos			0%	0%
Simmons, Nadine			0%	0%
Thompson, Olivia				

The software automatically switches to the Review Workspace with the selected document open.

## Viewing Data

You can view data in the Student pane or in the Data View pane. You can choose a student to view their answer, or you can choose an answer to view which students gave that answer.

### Viewing Data from the Student Pane

- ▶ Click a student name in the Student pane to view that answer in the Data View pane. You can select more than one student at a time.

The software highlights the selected student's answer in blue.

The screenshot shows the 'Review Toolbox' interface. On the left is a table with columns for 'Student', 'Response', and 'Time'. The table lists several students with their responses and times. On the right is a 'Data View' pane titled 'Which of these is not a rational number?'. It displays a bar chart with five bars representing different responses: 0.734 (1),  $\frac{3}{8}$  (1),  $\sqrt{5}$  (5), and 3.33333 (0). The bar for  $\sqrt{5}$  is highlighted in blue, corresponding to the selected student 'Li, Song' in the table.

Student	Response	Time
Baker, Susan	$\sqrt{5}$	11:50:18
Chopra, Laxmi	0.734	11:50:14
Huang, Shen	$\sqrt{5}$	11:50:36
Kapur, Samir	$\sqrt{5}$	11:50:05
Li, Song	$\sqrt{5}$	11:50:32
Lopez, Maria	$\sqrt{5}$	
Moore, Jacob	$\sqrt{5}$	11:50:28
Simmons, Nadine	$\sqrt{5}$	
Thompson, Olivia	$\frac{3}{8}$	11:50:25

If you switch between bar chart, table, and graph views, the software retains the selected information and highlights the responses from the selected students.

**Note:** Since student responses can vary for List questions, the software does not show List answers for selected students in the Data View pane.

### Viewing Data from the Data View Pane

- ▶ Click a response in the Data View pane to view the students who gave that response in the Student pane. You can select more than one response at a time.

The software highlights the corresponding student names in blue.

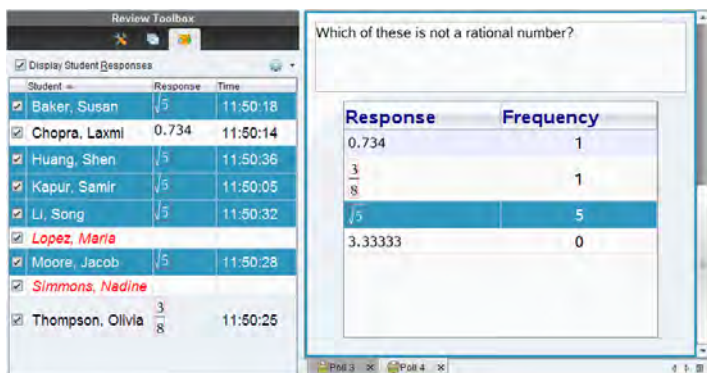

If you switch between bar chart, table, and graph views, the software retains the selected information and highlights the students who answered the selected response.

**Note:** If Multiple Choice questions have multiple responses, a blue area is displayed next to all responses from the selected student.

Response	Frequency
0.734	0
$\frac{3}{8}$	1
$\sqrt{5}$	4
3.3333	3

**Note:** For List questions, right-click anywhere in the table view, and then click **Show Student Column** to show student names next to their responses.

Student ▾	list1	list2
Thompson, Olivia	101	333
Thompson, Olivia	201	411
Thompson, Olivia	85	278
Kapur, Samir	444	411
Huang, Shen	101	145
Huang, Shen	201	411
Huang, Shen	85	275
Chopra, Laxmi	101	145

## Changing the Aspect Ratio

The Review Workspace displays graphs in a question application as they appear on the students' handhelds or computers. At times, the graphs may appear stretched, since the graph may have changed the aspect ratio to fit on the handheld.

You can select to view the graphs as they come in from students, or you can preserve the aspect ratio of the graph as it appeared when it was inserted in the question application.

By default, the Review Workspace displays graphs in a question application as they appear when the students submit them.

To preserve the aspect ratio of a graph as it appeared when it was inserted in the question, follow these steps:

1. View the data in graph view.
2. Right-click on the graph in the Data View pane, and then click **Graph Tools > Aspect Ratio**.

— or —

3. Click  in the Review Toolbox and then click **Graph Tools > Aspect Ratio**.

When the Aspect Ratio box is checked, the aspect ratio is preserved. When the box is not checked, the aspect ratio may change.

## Organizing Responses

You can configure a plot list for List questions, organize bar chart data and table views, individualize student responses, and organize Multiple Choice questions that have multiple responses into separate, group, or equivalent responses.

### Configuring a Plot List

The plot list settings let you set different shapes for the different plots to help you follow separate lines or responses on a graph.

To set the plot list settings, follow these steps.

1. While in graph view, click **Graph Tools** in the Review toolbox.

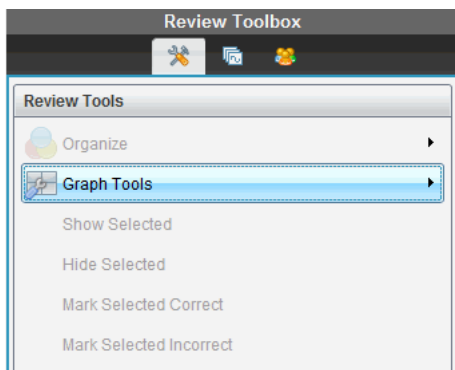

2. Click **Plot List Settings**.

The Configure Plot(s) dialog box opens.

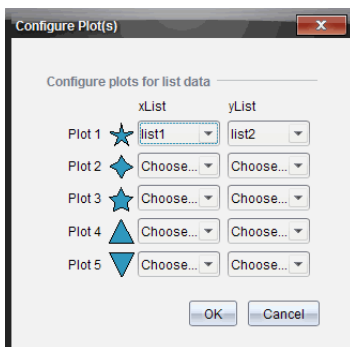

3. Click the down arrow next to a shape to choose which list to represent (list1, list2, and so forth) for the xList and yList.

**Note:** You can choose more than one shape for each list.

4. Click **OK**.

The graph view is updated with the shapes you selected.

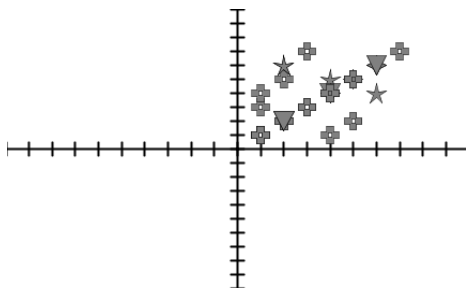

When you change plot list settings in the graph view, and then change to bar chart view, the software asks you to choose which lists to show in the bar chart. You can choose an individual list, or a list for the Category and Frequency.

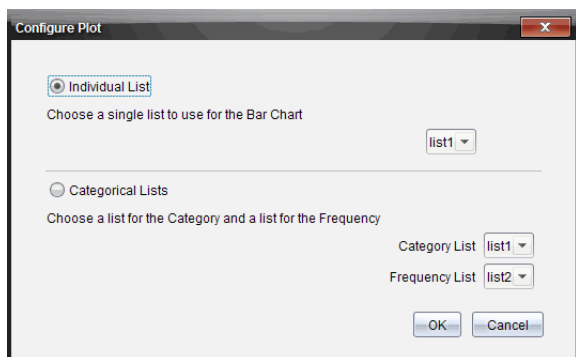

5. Select the applicable options and click **OK**.

If you click **Cancel**, the software shows the bar chart as an individual list, using list1 as the default.

You can configure the plot list at any time while in bar chart view.

**Note:** To configure the plot list from the bar chart view, click **Organize** in the Review toolbox and click **Plot List Settings**.

## Individualizing Student Responses

You can change the colors of each student response in a graph so you can identify the separate responses. This is useful when you are running a live activity; you can view the progress of individual students as they graph functions, move points on a graph, or respond to Quick Poll questions.

- ▶ To change the color of student responses, click **Graph Tools** in the Review toolbox, and then click **Individualize Student Responses**.

The responses are displayed in different colors in the Data View pane.



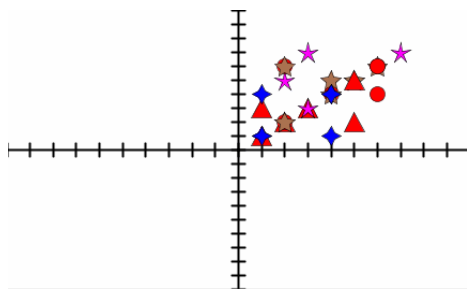

## Organizing List Data

In bar chart view, you can organize list data by Frequency, Numeric Value, or Alphabetically.

To organize list data, follow these steps.

1. In bar chart view, click **Graph Tools**.

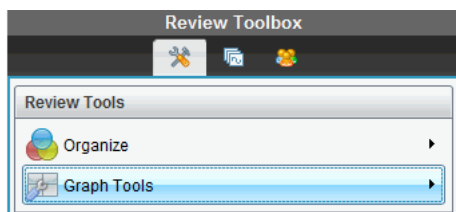

2. Select to sort the bars by Frequency, Numeric Value, or Alphabetically.

The bar chart view is updated in the Data View pane.

## Organizing Bar Chart Data

Organizing by separate responses shows the results for each individual response. For example, all of the A responses, all of the Bs, all of the Cs, and so forth. Organizing by group responses shows all multiple responses from the students. For example, all of the A plus B responses, all of the A plus C responses, and so forth.

Organizing by equivalency combines similar results into one bar. For example,  $y=4-x$ ,  $y=-x+4$ , and  $y=-(x-4)$  would all be combined into one bar or table row.

By default, Multiple Response questions are displayed as separate responses in the bar chart view.

Settings for organizing by separate or group responses and for organizing by equivalency are retained when you close and reopen the Review Workspace.

To organize by grouped responses, follow these steps.

1. Click the Organize tool in the Review toolbox.

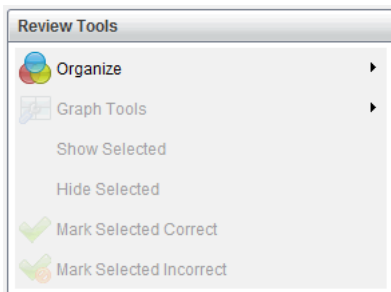

2. Click **Show Student Responses Grouped Together**.

The Data View pane shows the grouped responses.

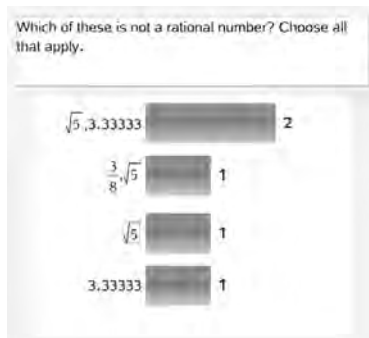

3. To return to the default view, click the Organize tool, and then click **Show Student Responses Separated**.

The Data View pane shows the data as separate responses.

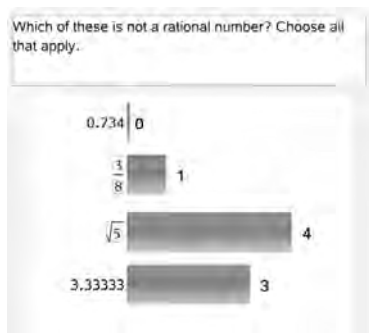

## Organizing by Equivalency

Organizing by equivalency groups all similar responses together in one bar or row. In bar chart view, you can still see separate responses by clicking on the bar.

To organize by equivalency, follow these steps.

1. Click the Organize tool in the Review toolbox.

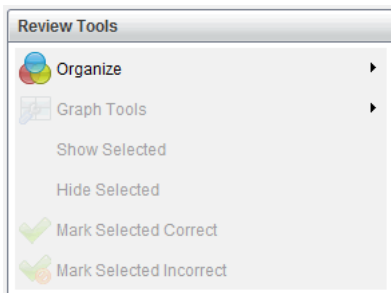

2. Click **Group Responses by Equivalence**.

The Data View pane shows the grouped responses.

3. To return to the default view, click the Organize tool, and then click **Group Responses by Exact Matches**.

The Data View pane shows the data as separate responses.

## Hiding and Showing Responses

You can hide one or more student responses in the Student pane or in the Data View pane. When you hide a response, the corresponding data updates, and the Data View pane does not show the hidden data. Settings for hiding or showing data are retained when you close and reopen the Review Workspace.

When you hide responses, the following actions occur in the different views.

- **Bar chart view.** The bar chart is updated and re-sorted using the current data.
- **Table view.** The table is updated and re-sorted using the current data.
- **Graph view.** The graph is updated using the current data. Any regression that was added is automatically recalculated and the new values are displayed.
- **Show your work.** The selected student's work is hidden from view.

## Hiding Responses from the Student Pane

To hide responses, follow these steps.

1. In the Student pane, select the students whose responses you want to hide.

The selected student responses are highlighted in blue in the Data View pane.

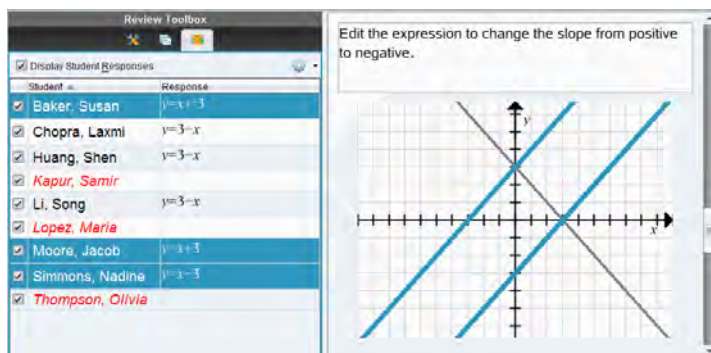

The screenshot shows the Review Toolbox interface. On the left, a table lists students and their responses. The responses for Baker, Susan; Chopra, Laxmi; Huang, Shen; Li, Song; Lopez, Maria; Moore, Jacob; and Simmons, Nadine are highlighted in blue. On the right, a graph shows a coordinate plane with a grid. A black line with a negative slope is plotted, and a blue line with a positive slope is also plotted. The text above the graph says "Edit the expression to change the slope from positive to negative."

Student	Response
<input checked="" type="checkbox"/> Baker, Susan	$y = x + 3$
<input checked="" type="checkbox"/> Chopra, Laxmi	$y = 3 - x$
<input checked="" type="checkbox"/> Huang, Shen	$y = 3 - x$
<input checked="" type="checkbox"/> Kapur, Samir	
<input checked="" type="checkbox"/> Li, Song	$y = 3 - x$
<input checked="" type="checkbox"/> Lopez, Maria	
<input checked="" type="checkbox"/> Moore, Jacob	$y = x + 3$
<input checked="" type="checkbox"/> Simmons, Nadine	$y = 3 - x$
<input checked="" type="checkbox"/> Thompson, Olivia	

2. Click the Options menu , and then click **Hide Selected**, or clear the check box next to the student name.

The Data View pane hides the responses of the students you selected, and shows the responses of the remaining students.

The student names you selected are displayed in gray text.

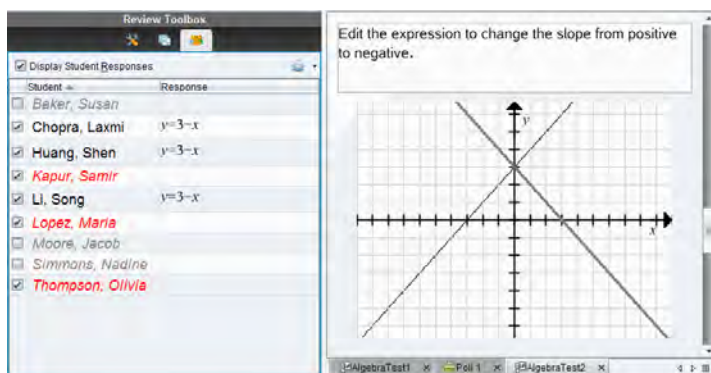

The screenshot shows the Review Toolbox interface. On the left, a table lists students and their responses. The names for Baker, Susan; Moore, Jacob; and Thompson, Olivia are displayed in gray text, indicating they are selected. The responses for these students are hidden. On the right, a graph shows a coordinate plane with a grid. A black line with a negative slope is plotted, and a black line with a positive slope is also plotted. The text above the graph says "Edit the expression to change the slope from positive to negative."

Student	Response
<input type="checkbox"/> Baker, Susan	
<input checked="" type="checkbox"/> Chopra, Laxmi	$y = 3 - x$
<input checked="" type="checkbox"/> Huang, Shen	$y = 3 - x$
<input checked="" type="checkbox"/> Kapur, Samir	
<input checked="" type="checkbox"/> Li, Song	$y = 3 - x$
<input checked="" type="checkbox"/> Lopez, Maria	
<input type="checkbox"/> Moore, Jacob	
<input type="checkbox"/> Simmons, Nadine	
<input checked="" type="checkbox"/> Thompson, Olivia	

**Note:** If a response is hidden, click a student name to show the response. The response is displayed in blue in the Data View pane. All bar chart, table, and graph views are updated with the selected data. The response stays in view until you select a different student.

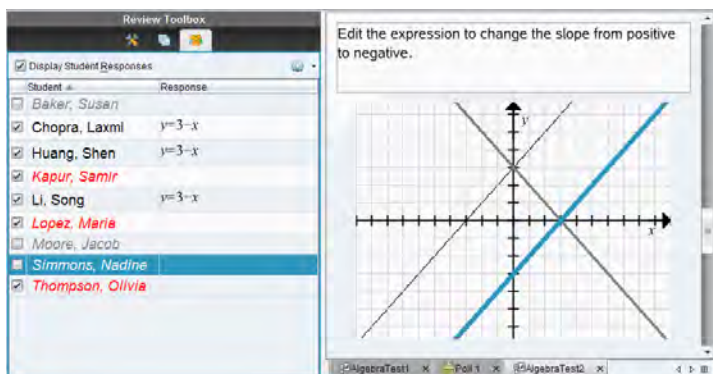

## Hiding Responses from the Data View Pane

You can hide responses in the bar chart, graph, or table views. When you hide responses, the Data View pane updates the data and does not show the hidden responses. In the Student View, student names are displayed in gray. In Page Sorter view, the software does not change the documents or icons.

To hide responses, follow these steps.

1. In the Data View pane, select the responses you want to hide.

The selected students are highlighted in blue in the Student pane.

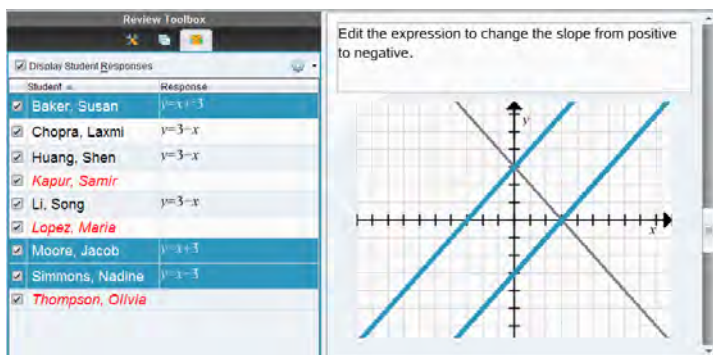

2. Right-click the response and click **Hide Selected**.

The Data View pane hides the responses you selected, and shows the responses of the remaining students.

The student names that correspond with the responses you selected are displayed in gray text.

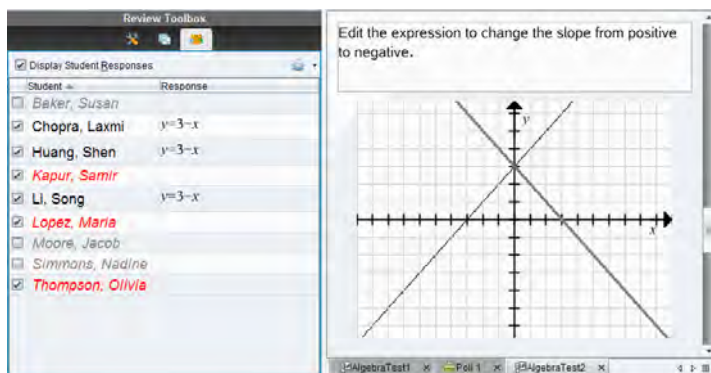

## Showing Responses

To show the hidden responses, follow these steps.

1. In the Student pane, select the students whose responses you want to show.
2. Click the Options menu , and then click **Show Selected**.

The student names are displayed in black and student responses are shown in the Data View pane.

## Marking Responses as Correct or Incorrect

You can use the Review Workspace to mark selected answers as correct or incorrect. If you are reviewing a document with a correct answer already marked, you can change the correct answer. In a Multiple Choice question with multiple responses, you can add additional correct answers.

If the **Show Correct Answer** box is checked, answers marked as correct are highlighted in green.

The software reevaluates the data based on the correct responses, and the Data View pane updates the view to reflect the changes.

To mark a response as correct:

- ▶ In the Student pane, right-click a student and click **Mark as Correct**.
- ▶ In the Data View pane, right-click a response and click **Mark Selected Correct**.
- ▶ In the Data View pane, click a response and click **Mark Selected Correct** in the Review Tools pane.

In Multiple Choice questions with multiple answers, check marks are displayed next to the responses.

- ▶ Click a check mark to mark a response as correct.

When you mark a response as incorrect, the software removes the green highlight.

To mark a response as incorrect:

- ▶ In the Student pane, right-click a student and click **Remove as Correct**.
- ▶ In the Data View pane, right-click a response and click **Mark Selected Incorrect**.
- ▶ In Multiple Choice questions with multiple answers, click the green check mark.

**Note:** If you change an answer to correct or incorrect, any points you already manually awarded students for correct or incorrect answers will not be changed.

When you mark responses, the following actions occur in the different question types.

Question Types	Action
Multiple Choice, Single Response Image: Label, Single Response Image: Point on, Single Response	Adding a new answer replaces the current answer. Removing an answer leaves the question with no correct answers.
Multiple Choice, Multiple Responses Image: Label, Multiple Responses Image: Point on, Multiple Responses	Adding a new answer increases the correct answer set. For example, an answer of "A and B" becomes "A and B and C." Removing an answer decreases the correct answer set.

Question Types	Action
Open Response: Explanation Open Response: Text Match Equation: $f(x)$ and $y=$ Coordinate Points Expression: Variable Chemical	Adding a new answer increases the correct answer set. Removing an answer leaves the question with no correct answers.
Expression: Numerical	Adding a new answer, with or without tolerance, replaces the current answer. Removing an answer leaves the question with no correct answers.

The following examples show answers marked as correct in different data views.

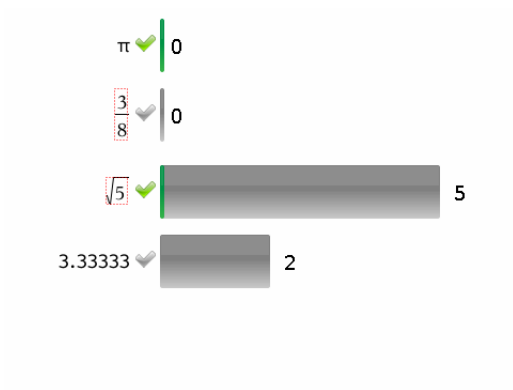

Bar chart view, Multiple Choice question with multiple responses and two correct answers, organized by Show Student Responses Separate, and no student selected in the Student pane.



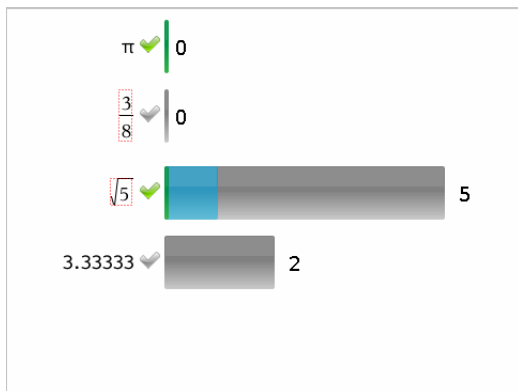

Bar chart view, Multiple Choice question with multiple responses and two correct answers, organized by Show Student Responses Separate, and one student selected in the Student pane.

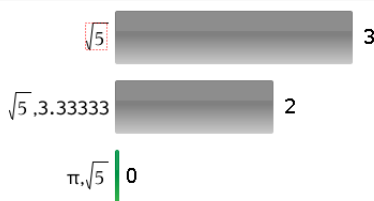

Bar chart view, Multiple Choice question with multiple responses and two correct answers, organized by Show Student Responses Grouped Together, and no students selected in the Student pane.

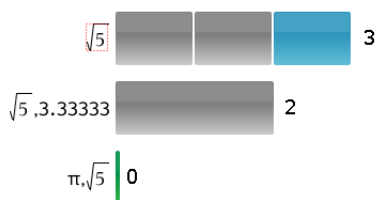

Bar chart view, Multiple Choice question with multiple responses and two correct answers, organized by Show Student Responses Grouped Together, and one student selected in the Student pane.

Response	Frequency
0.734	0
$\frac{3}{8}$	1
$\sqrt{5}$	1
3.33333	2

Frequency table view, Multiple Choice question with one correct answer, and no student selected in the Student pane.

Student	Response
Chopra, Laxmi	$\sqrt{5}$
Garcia, Rafe	3.33333
Ortega, Carlos	3.33333
Simmons, Nadine	$\frac{3}{8}$

Student table view, Multiple Choice question with one correct answer, and one student selected in the Student pane.

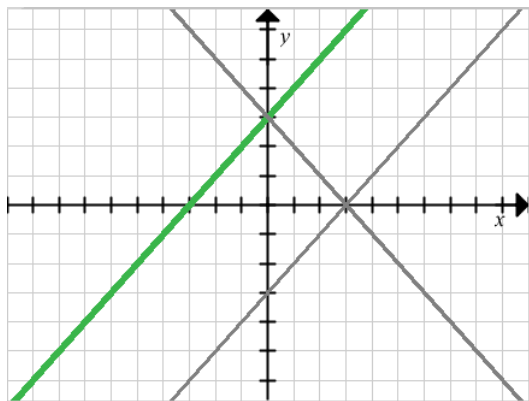

Graph view, Equation  $y =$  question with one correct answer, and no student selected in the Student pane.

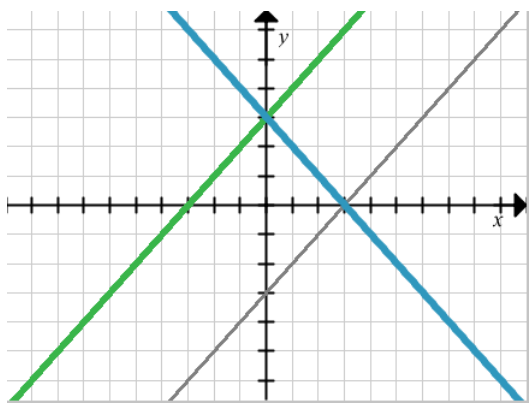

Graph view, Equation  $y =$  question with one correct answer, and one student selected in the Student pane.

## ***Adding Teacher Data***

There may be times you want to add your own data to a graph you are reviewing in class. The Graph Tools allow you to add teacher points and teacher equations to a graph, and to set the plot list settings and individualize student responses.

Teacher data is displayed larger than student data, and in a different color.

When you add teacher data, the software reevaluates the data, and the Data View pane updates the view to reflect the changes.

You can hide and show teacher data, but you cannot mark a teacher response as correct or incorrect.

## Adding Teacher Points

1. Click **Graph Tools** in the Review toolbox.

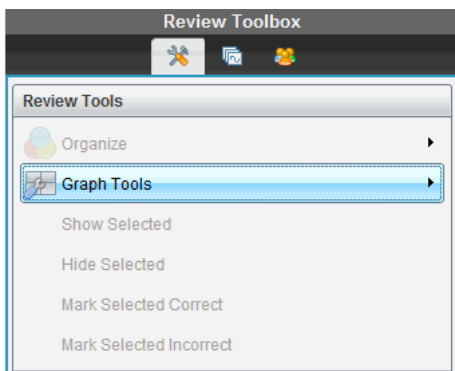

2. Click **Add Teacher Point**.

The Add Teacher Point dialog box opens.

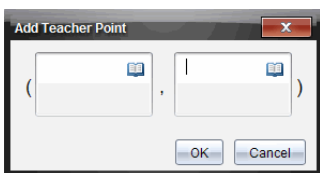

3. Type your information in the fields.

Click  to open math templates and symbols that you can add to the fields.

4. Click **OK**.

Your point is displayed on the graph, and the name **Teacher** is added to the list of names in the Student pane.

**Note:** The teacher may have multiple entries.

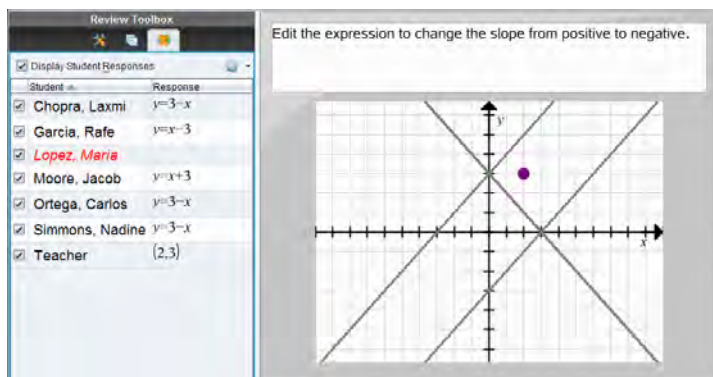

## Adding Teacher Equations

1. Click **Graph Tools** in the Review toolbox.

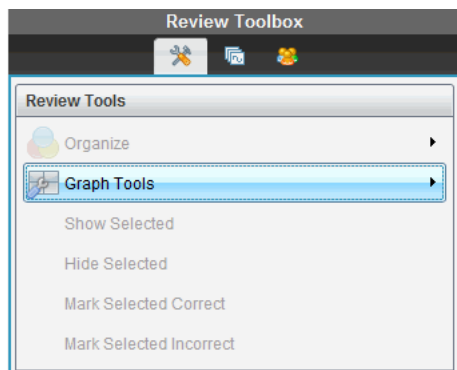

2. Click **Add Teacher Equation**.

The Add Teacher Equation dialog box opens.

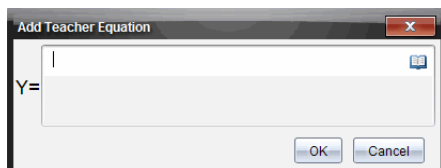

3. Type your information in the field.

Click  to open math templates and symbols that you can add to the fields.

#### 4. Click **OK**.

Your line is displayed on the graph, and the name **Teacher** is added to the list of names in the Student pane.

**Note:** The teacher may have multiple entries.

## ***Saving to the Portfolio Workspace***

You can save documents that contain questions and Quick Polls to the Portfolio Workspace, where you can review and analyze individual responses, and assign or change a student's grade.

When you save Quick Polls to Portfolio, students can continue to submit answers to the Quick Poll until you stop the poll. The saved Quick Poll in Portfolio automatically updates without you having to save it again.

**Note:** If you opened the file from the Portfolio Workspace, or if you have already saved the file to Portfolio, the software does not ask you for a file name. The software saves the file to the Portfolio Workspace with the existing file name, and updates any grades you had given students. You can go to the Portfolio Workspace and change a grade at any time.

To save a file to the Portfolio Workspace:

1. Click **File > Save to Portfolio**, or click .

The Save to Portfolio dialog box opens. By default, the name of the file is shown in the **Portfolio name** box. If the file is a Quick Poll you have not saved yet, the default name is *<Class name, Quick Poll Set#, mm-dd.tns>*. For example: Algebra1 - Mrs. Smith, QP Set 2, 10-26.tns.

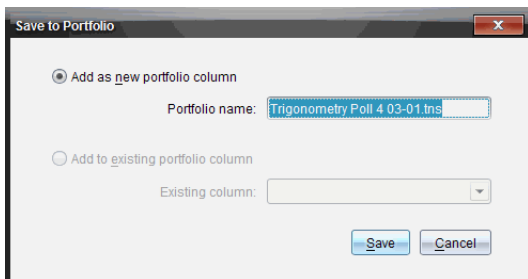

- To add a new Portfolio column, select **Add as new portfolio column**. You can use the existing name or type a new name.

- To add the file to an existing portfolio column, select **Add to existing portfolio column**. Click the down arrow to select the column.

**Note:** Quick Polls cannot be added to existing columns.

2. Click **Save**.

The file is saved in the Portfolio Workspace.

## ***Saving Data as a New Document***

You can take data collected from students, view it in table form, and save it as a Lists & Spreadsheet document. This document can be used as an instructional aid or sent to the students for further analysis.

**Note:** If the data comes from a Lists question, the column titles in the Table View are used as the names for the list variables. If the variable names are not usable, the software renames them. For instance, if the name has a space, the software replaces it with an underscore.

1. To save data to a new Lists & Spreadsheet document, make sure you are viewing the data in table view.
2. Right-click anywhere in the table, and then click **Send Table to New Document**.

**Note:** Hidden data is not sent. If data is sorted, the sort order is retained in the new document.

The Lists & Spreadsheet document opens in the Documents Workspace.





# Using the Portfolio Workspace

Use this workspace to save, review, modify grades, and manage class assignments from students.

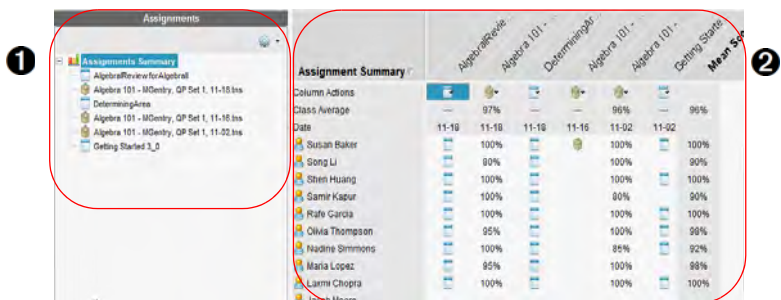

- 1 Assignments pane.** Select assignments to view student information and scores. You can redistribute, rename, or remove an assignment.
- 2 Work area.** Lists the students in the selected class and shows the scores received for each assignment. Enables you to view class or student assignments; sort by assignment, score, or student; and edit assignment scores.

## Exploring the Assignments Pane

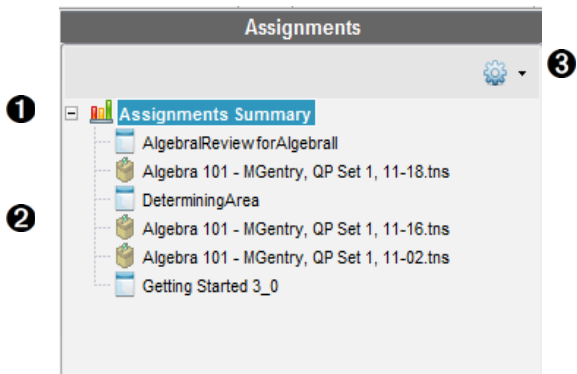

- ❶ **Assignments Summary.** Lists the names of the assignments that you saved to the Portfolio Workspace. Shows a class and student average in the workspace.
  - Click the minus sign (–) to collapse the list of individual assignments and view only the Assignments Summary.
  - Click the plus sign (+) to show the list of individual assignments.
- ❷ **Individual assignments.** Click an assignment to see the student scores for that assignment.
- ❸ **Options menu.** Available when you select an individual assignment. Click  to open a menu that allows you to:
  - Open the document in the Review Workspace.
  - Redistribute the assignment to the current class.
  - Remove the assignment from the Portfolio Workspace. The assignment still exists in other workspaces.
  - Rename the assignment.

## Exploring the Workspace Views

The appearance of the workspace changes depending on what you selected in the Assignments pane.

### Assignments Summary View

This work area opens when you select **Assignments Summary** in the Assignments pane.

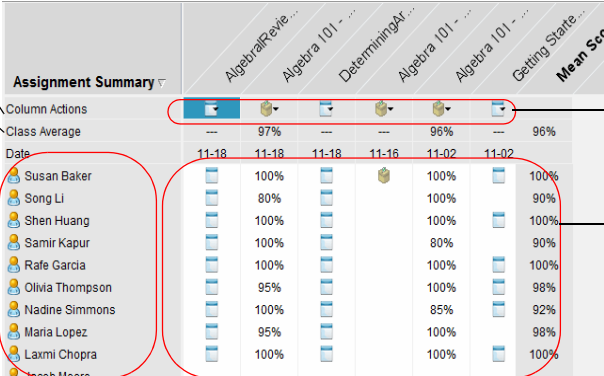

	Algebra 101 - ...	Algebra 101 - ...	DeterminingAl...	Algebra 101 - ...	Algebra 101 - ...	Getting Started...	Mean Score
Class Average	97%	97%	97%	96%	96%	96%	96%
Date	11-18	11-18	11-18	11-16	11-02	11-02	
Susan Baker	100%	100%	100%	100%	100%	100%	100%
Song Li	80%	80%	80%	100%	100%	90%	90%
Shen Huang	100%	100%	100%	100%	100%	100%	100%
Samir Kapur	100%	100%	100%	80%	90%	90%	90%
Rafe Garcia	100%	100%	100%	100%	100%	100%	100%
Olivia Thompson	95%	95%	95%	100%	98%	98%	98%
Nadine Simmons	100%	100%	100%	85%	92%	92%	92%
Maria Lopez	95%	95%	95%	100%	98%	98%	98%
Laxmi Chopra	100%	100%	100%	100%	100%	100%	100%
Jacob Moore							

- ❶ **Column Actions.** Lets you perform certain actions on a column. Click a file icon anywhere in this row to:
- Open an assessment for review in the Review Workspace.
  - Sort assignments in ascending or descending order by student.
  - Open the Master in the Review Workspace.
  - Remove from Portfolio.
  - Rename the assignment.

- ❷ **Class Average.** Shows the average score of the class for the assignment in that column.

- ❸ **Date.** Shows the date the file was collected. The date the last file was collected is shown in the first column on the left.

- ❹ **Students.** Lists all students in the class.

- ❺ **Column Header.** Shows the name of the assignment saved to the Portfolio Workspace. You can perform the same actions on the column header as you can on the column actions. Right-click the column header to open the menu.

The column header **Mean Score** shows the mean score for all assignments and the mean score for all assignments per student. Right-click the **Mean Score** column to sort by ascending or descending scores.

- ❻ **File icon.** Shows the type of file. The file types shown are:



Quick Poll



PublishView™ file

(Shown only in the TI-Nspire™ Navigator™ NC Teacher Software)



TI-Nspire™ file



Other file types

(Shown only in the TI-Nspire™ Navigator™ NC Teacher Software)

- ❼ **Student scores.** If questions are automatically graded, the scores are shown. You can change a student's score for an assignment.

## Individual Assignment View

This work area opens when you select a single assignment in the Assignments pane. To view this work area, the assignment you select must be a .tns file that contains one or more questions.

**Note:** In the TI-Nspire™ Navigator™ NC Teacher Software, you can also open .tnsp files.

AlgebraTest2B	1	2	3	+Points	Total	%	%
Total Possible ...	10.0	10.0	5.0	75.0	100.0	Raw	Final
Moore, Jacob	10.0	10.0	5.0	75.0	100.0	100%	100%
Chopra, Laxmi	10.0	10.0	5.0	75.0	100.0	100%	100%
Ortega, Carlos	10.0	10.0	5.0	75.0	100.0	100%	100%
Lopez, Maria	10.0	9.0	5.0	75.0	99.0	99%	99%
Simmons, Nadi...	9.0	10.0	5.0	75.0	99.0	99%	99%
Garcia, Rafe	8.0	10.0	5.0	75.0	98.0	98%	98%
Huang, Shen	10.0	10.0	3.0	70.0	93.0	93%	93%
Thompson, Olivia							
Kapur, Samir							
Li, Song							
Average	96%	99%	94%	74.28571428...	98.4285714...	98%	98%

❶ Name of the selected assignment.

❷ **Total Possible.** This row shows the points for these categories:

- Total possible points for each question in the assignment. You can edit this number.
- Total number of extra points possible for the assignment. You can edit this number.
- Total points for the assignment.
- Raw score based on the number of points the student received divided by total possible points.
- Final percentage. This number updates when you edit possible points or extra points. You can edit this score. The final score is the same as the raw score, unless you change it.

If you edit the final score, it no longer updates if the other points change.

❸ **Student names.** All students who received the selected assignment. Right-click to open and edit the document in the Documents Workspace, or to open the document for review in the Review Workspace.

- 4 **Average.** Shows the average score for all students, as well as average total points, raw score, and final score.
- 5 **Questions in the assignment.** If the document contained multiple questions, each question is displayed here, along with the total possible score for that question.
- 6 **Scores.** Lists the score each student received for the selected assignment. Each page in an assignment may have a separate score. Right-click to edit the score, open the assignment in the Documents Workspace, or open the document in the Review Workspace.
- 7 **Scroll bar.** Appears when there are more questions in the assignment to view, or more students to view.

## ***Saving an Item to the Portfolio Workspace***



If you are using the TI-Nspire™ software for the first time, the Portfolio Workspace may be empty. You need to save files to the Portfolio Workspace to view and edit scores, and perform other work on the files.

You can save collected, unprompted, and Quick Poll files to the Portfolio Workspace. You can save to the Portfolio Workspace from the Class and Review Workspaces.

When you save Quick Polls to Portfolio, students can continue to submit answers to the Quick Poll until you stop the poll. The saved Quick Poll automatically updates without you having to save it again.

**Note:** If you opened the file from the Portfolio Workspace, or if you have already saved the file to the Portfolio Workspace, the software does not ask you for a file name. The software saves the file to the Portfolio Workspace with the existing file name, and updates any grades you had given students. You can change a grade in the Portfolio Workspace at any time.

To save a file to the Portfolio Workspace, follow these steps.

1. Select the files you want to save.
  - From the Class Record in the Class Workspace, click  , and then click **Save selected to Portfolio**.
  - From an open file in the Review Workspace, click **File > Save to Portfolio**, or click .

The **Save to Portfolio** dialog box opens.

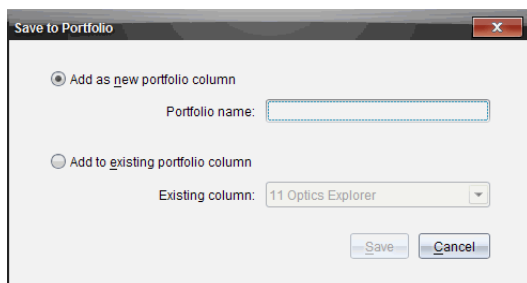

2. Save the files to a new Portfolio column or add them to an existing Portfolio column.
  - To add the files to a new Portfolio column, select **Add as new portfolio column**. You can use the existing name, or type a new name.
  - To save the files to an existing Portfolio column, select **Add to existing portfolio column**. Click the down arrow to select the desired column from the drop-down list.

**Note:** Quick Polls cannot be added to existing columns.

3. Click **Save**.

The file is saved in the Portfolio Workspace.

**Note:** The files you saved in the Portfolio Workspace remain in the Class Record until you remove them using the Remove command.

If a file is deleted from the Class Record, that delete action does not affect the file copy in the Portfolio Workspace. The copy remains in the Portfolio Workspace until it is deleted.

## ***Importing an Item to the Portfolio Workspace***

You can import a .tns file from your computer to a student's Portfolio entry.

1. Click **Assignments Summary**.
2. Highlight a cell in the student row where you want to import the file.

**Note:** You can import a file for only one student at a time.

3. Click **File > Import Item**.

The Open dialog box is displayed.

4. Navigate to the file you want to import and click it.

## 5. Click **Import**.

If a file already exists in that cell, you are prompted to confirm the file replacement.

- Click **Replace** to save your imported file over the existing file.
- Click **Keep Existing** to keep the existing file and cancel the import file function.

## Editing Scores

There may be times when you want to edit a student's score. For example, an Open Response assignment contains a question that requires the word "Autumn" as the correct answer. One student has entered "Fall." If you want to give the student full or partial credit, you can do so by changing the student's score for the question.

In addition to editing an individual student score, you can edit the total possible points for each question, the extra points, and the final percentage.

- ▶ Use whole numbers to edit the scores. For example, type 75 to give a score of 75%, type 100 to give a score of 100%, and so forth.

**Note:** If you type a score and do not press **Enter**, the change is not made, and the previous score remains in place.

## Previewing a Student's Answer

You can preview a student's answer to an individual assignment question in the Preview Pane. This provides a quick, easy, and efficient method for the review of questions, answers, and the modification of scores.

**Note:** The assignment must contain at least one question to be previewed.

1. Click an individual assignment in the Assignments Summary list.
2. Select the question cell you want to preview.

The screenshot shows the 'Assignments' section of the Portfolio Workspace. On the left is a tree view of assignments. The main area displays a table for 'Algebra 10 - Q1' with columns for 'Total Possibl', '+Points', 'Total Pos.', '%', 'Raw Sc.', and 'Final Score'. The table lists scores for Susan Baker, Laram Chopra, Shen Huang, and an overall Average. Below the table is a 'Preview Pane' for 'Q1 Question' showing the question text, a student's answer, the correct response, and choices.

Algebra 10 - Q1	+Points	Total Pos.	%	Raw Sc.	Final Score
Total Possibl	1.0	0.0	1.0		
Susan Baker	1.0	0.0	1.0	100%	100%
Laram Chopra	1.0	0.0	1.0	100%	100%
Shen Huang	1.0	0.0	1.0	100%	100%
Average	36%	0.0	0.4	36%	93%

**Q1 Question:**  
The last variable should  
Susan Baker Answered  
Be absolute  
Correct Response:  
Be absolute  
Choices:

The following information is shown in the Preview Pane.

- **Q# Question.** Original question with icon showing correct or incorrect response
- **Student's Answer.** Student's response
- **Correct Response.** Teacher's correct response (blank if there is no correct response)

**Note:** Depending on the question posted, additional information may be displayed.

## Modifying a Student's Score for an Assignment

You can edit the score for an assignment from the Assignments Summary view, or you can edit the score for individual questions in an assignment from the Individual Assignments view. These steps describe how to change a score from either view.

1. In the student row, select the score you want to edit.
2. Right-click the cell and click **Edit Score**.
3. Type the replacement score, and press **Enter**. To cancel, press **Esc**.

## Changing the Total Possible Points for a Question

You can edit the total possible score for individual questions or extra points.

1. Select a cell in the Total Possible row.
2. Right-click the cell and click **Edit Score**.
3. Type the points for the question or for extra points, and press **Enter**.

The software asks if you want to keep the student scores for the question, or reassess the scores for each student. The default setting is to reassess the scores for each student.

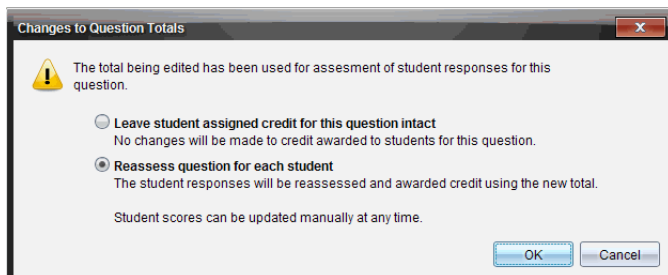

- To keep the student scores without making changes, select **Leave student assigned credit for this question intact**.



- To reassess the score for each student, select **Reassess question for each student**.

4. Click **OK**.

## Changing the Final Percentage Score

1. In the Individual Assignments view, select the student whose score you want to edit.
2. Right-click the cell in the Final column, and click **Edit Score**.
3. Type the replacement score and press **Enter**. To cancel, press **Esc**.

**Note:** If you edit the final score, it retains the edited value and no longer updates if you edit other values in the row.

## Exporting Results

If you or your school district use electronic gradebook software and reporting, you may want to export scores to these programs. You can export scores from Portfolio Workspace as a .csv formatted file. The export action includes all scores for all students on the selected assignment, or for all assignments.

The .csv file contains all the columns and rows in the workspace except for the Column Actions row. If a student had an empty cell with no score, the .cvs file displays a cell that is empty.

## Exporting the Current View

This allows you to export all data shown in the Portfolio Workspace for a single assignment.

1. Choose an assignment from the list.
2. Click **File > Export Data** or click .
3. Select **Export Current View**.

The Export Data dialog box opens.

- The default location is the My Documents folder.
- The default name is the name of the assignment.

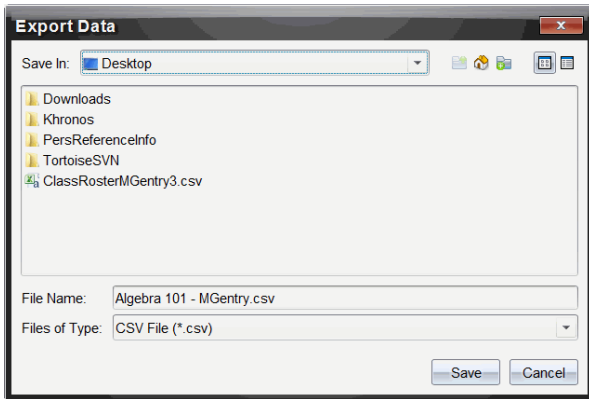

4. Navigate to the location where you want to save the file.
5. Click **Save**.

## Customizing an Export

Custom Export allows you to export the final scores for one or more assignments. This is useful for reporting scores over a date range with only the student name and final score exporting.

1. Click **File > Export Data** or click .
2. Select **Custom Export**.

The Custom Export dialog box opens.

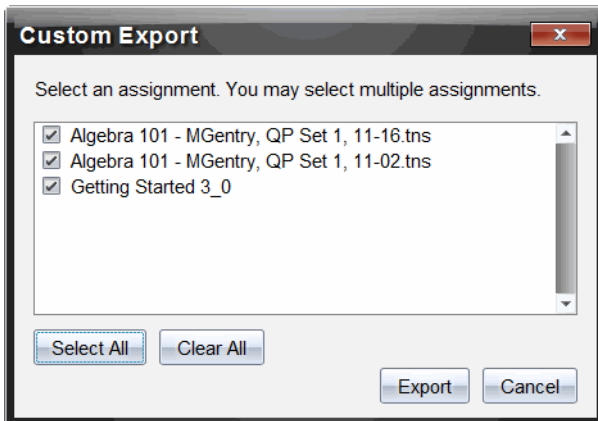

3. Choose the assignments you want to export.
  - Select the check box by assignment name.

- Click **Select All** to select all assignments.
  - Click **Clear All** to clear selections.
4. Click **Export**.  
The Export Data dialog box opens.
    - The default location is the My Documents folder.
    - The default name is the name of the assignment.
  5. Navigate to the location where you want to save the file.
  6. Click **Save**.

## ***Sorting Information in the Portfolio Workspace***

1. Click the column header of the list you want to sort.  
The selected list can be sorted in ascending, descending, or student name order.
2. Click the column header again to sort in another order.

## ***Opening a Portfolio Item in Another Workspace***

You can open a .tns file in the Documents Workspace to edit it; or you can open a .tns or Quick Poll file in the Review Workspace to view student responses in bar chart, table, or graph views.

**Note:** In the TI-Nspire™ Navigator™ NC Teacher Software, you can also open .tnsp files.

## **Opening an Item in the Documents Workspace**

1. Click the file you want to open.  
To open a file for all students:
  - From the Assignments Summary list, click the file.
  - From the Assignments Summary view, click the icon in the Column Actions row, or click the Column Header.To open a file for selected students:
  - From the Assignments Summary view, select a cell in a selected student's row. You can open more than one file in a column, but you cannot open multiple files from different columns.
  - From the Individual Assignments view, select a cell in the selected student's row.

2. Click **File > Open for Editing** or right-click and click **Open for Editing**.  
The file opens in the Documents Workspace.

## **Opening an Item in the Review Workspace**

1. Click the file you want to open using one of these methods:
  - From the Assignments Summary list, select the file.
  - From the Assignments Summary view, click the icon in the Column Actions row, or click the Column Header.
  - From the Assignments Summary view, click a cell in a selected student's row. You can open more than one file in a column, but you cannot open multiple files from different columns.
  - From the Individual Assignments view, click a cell in the selected student's row.

**Note:** Any method you choose in the Review Workspace opens the file with all student responses. You cannot open a file for just one student. However, you can select review responses for an individual student in the Review Workspace.

2. Click **File > Open in Review Workspace** or right-click and click **Open in Review Workspace**.  
The file opens in the Review Workspace.

## **Opening a Master Document**

A Master Document is the original document that was sent to students, and it contains the answer key for evaluating the responses collected from students. When you save a document to a column in the Portfolio Workspace, there is usually a Master Document associated with that file.

You can open the Master Document from the Portfolio Workspace in the Assignments Summary view. When you open the Master Document, it opens in the Documents Workspace as a read-only file.

1. In the Column Actions row, click the icon corresponding to the file you want to open.
2. Right-click the icon and click **Open Master Document**.  
The document opens in the Documents Workspace as a read-only file.

## ***Adding a Master Document***

There may be times when you want to replace an existing Master Document, or add a Master Document to an assignment that does not have one. For example, a question was marked with an incorrect answer and students did not receive credit for that answer. You can give students credit by changing the answer to that question, and retain the Master Document as a permanent record of the correct answer key.

**Note:** You can add or replace a Master Document for a .tns file, but not for a Quick Poll file.

The new Master Document is used to evaluate student scores. The evaluation works as follows:

- If a question changed, student answers are evaluated for the new question.
- If the new Master Document has questions that were not in the old Master Document, those questions are evaluated. Students may receive zero credit for those questions if they have not seen them.

To add or replace a Master Document, follow these steps:

1. In the Column Actions row, click the icon corresponding to the .tns file you want to open.

2. Click **File > Add Master Document**.

A dialog box opens where you can select a file.

3. Navigate to the .tns file you want to use as the new Master Document and click **Open**.

The software displays a message warning that replacing the Master Document will cause the software to reevaluate the student scores.

4. Click **Add/Replace Master** to assign the new Master Document, or click **Cancel** to cancel the action.

## ***Redistributing a Portfolio Item***

Redistributing a file to the class is a useful way to return graded assignments or to return assignments for additional work. Class must be in session to redistribute a file.

**Note:** You cannot redistribute a Quick Poll file.

1. Right-click the item you want to redistribute.

2. Click **Redistribute to Class**, or click .

The system sends the file to each student logged onto the TI-Nspire™ Navigator™ network.

## ***Collecting Missing Files from Students***

There may be times when you store a set of student files to the Portfolio Workspace and the collection is incomplete because not all students were present, had the file ready for collection, or were not logged on. Class must be in session to collect a file.

1. Select an individual file, or click a file icon on the Column Actions row to select all files in that column.

**Note:** You can collect only one column of files at a time.

2. Click **Collect Missing**.

Missing files are collected from those students who are logged onto the network and whose files were not initially collected.

## ***Sending Missing Files to Students***

There may be times when you send a set of files to students and the send is incomplete because not all students were present, or logged on, or a new student was added to the class. Class must be in session to send a missing file.

1. Select an individual file, or click a file icon on the Column Actions row to select all files in that column.

**Note:** You can only send files contained in one column at a time.

2. Click **Send Missing**.

Missing files are sent to those students who are logged onto the network and who did not initially receive the files.

## ***Renaming a Portfolio Item***

You can rename an assignment from the Assignments pane or from the column header.

1. Click the assignment name or column header you want to rename.
2. Right-click and click **Rename**.

The Rename Portfolio Column dialog box opens.

3. Type the new name.

4. Click **Rename**. Click **Cancel** to cancel the request.

The column appears in the column header and in the Assignments pane with the new name.

## ***Removing Columns from Portfolio***

There may be times you want to delete files from Portfolio. For example, an incorrect file was sent to or collected from a class. You can remove an assignment from the Assignments pane or from the column header.

1. Click the assignment name or column header you want to remove.
2. Right-click and click **Remove From Portfolio**.

The Remove from Portfolio dialog box opens.

3. Click **Remove** to delete the file. Click **Cancel** to cancel the request.

**Note:** If a file is saved to the Portfolio Workspace and later deleted from the Class Record, that delete action does not affect the file copy in the Portfolio. The copy remains in the Portfolio Workspace until it is deleted.

## ***Removing Individual Files from Portfolio***

There may be times you want to delete a single file or a few files from a column list, but not all of the files. For example, an incorrect file was collected from a student. Remove individual files from the work area in the Assignments Summary view.

1. Click the file or files within a single column that you want to delete.
2. Press **Delete**.

The Remove Selected Document(s) dialog box opens.

3. Click **Remove** to delete the files. Click **Don't Remove** to cancel the request.

## Summary of File Type Options

	<b>.tns</b>	<b>.tns with questions</b>	<b>.tnsp</b>	<b>Quick Poll</b>	<b>Other file types</b>
Save to Portfolio	✓	✓	✓	✓	✓
Save Selected to Portfolio	✓	✓	✓	✓	✓
Edit Score	✓	✓		✓	✓
Open in Review Workspace		✓		✓	
Open for Editing	✓	✓	✓		✓*
Redistribute to class	✓	✓	✓		✓
Open Master Document	✓	✓	✓	✓	✓
Add Master Document	✓	✓			
Export Data	✓**	✓**	✓**	✓**	✓**
Send/Collect Missing	✓	✓	✓		✓
Rename Portfolio Column of files	✓	✓	✓	✓	✓
Remove Portfolio Column of Files	✓	✓	✓	✓	✓
✓*	The file opens in the program the operating system has associated with the file type.				
✓**	Empty, non-graded, and "Other file types" show "No score" in the cell when exported.				



# Working with Images

Images can be used in TI-Nspire™ applications for reference, assessment, and instructional purposes. You can add images to the following TI-Nspire™ applications:

- Graphs & Geometry
- Data & Statistics
- Notes
- Question, including Quick Poll

In the Graphs & Geometry and Data & Statistics applications, images are set in the background behind the axis and other objects. In the Notes and Question applications, the image is set at the cursor location inline with the text (in the foreground).

You can insert the following image file types: .jpg, .png, or .bmp.

**Note:** The transparency feature of a .png file type is not supported. Transparent backgrounds are displayed as white.

## ***Working with Images in the Software***

When working in the TI-Nspire™ software, you can insert, copy, move, and delete images.

### **Inserting Images**

In the Notes and Question applications, and in Quick Poll, you can insert more than one image on a page. You can only insert one image on a page in the Graphs & Geometry and Data & Statistics applications.

1. Open the document where you want to add an image.
2. Click **Insert > Image**.

The Insert Image dialog box opens.

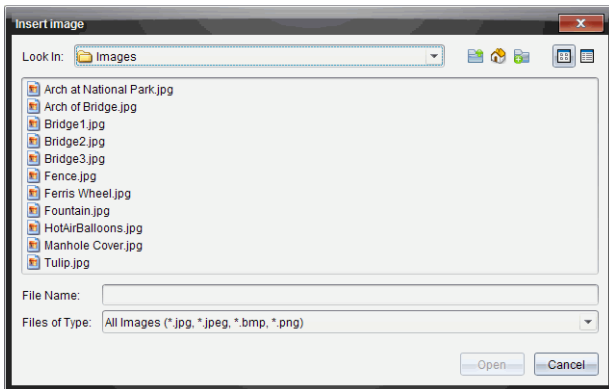



3. Navigate to the folder where the image is located and select the image.
4. Click **Open**.
  - In the Graphs & Geometry and Data & Statistics applications, the image is inserted in the background behind the axis.
  - In Notes, Question, and Quick Poll, the image is inserted at the cursor location. You can type text above or below the image, and you can move the image up or down on the page.

**Note:** You can also insert images by copying an image to the Clipboard and pasting it into the application.

## Moving Images

In applications such as Notes and Question where the image is set at the cursor location, you can reposition the image by moving the image to a new line or blank space, or by placing the image within a line of text. In the Graphs & Geometry and Data & Statistics applications, images can be moved to any position on the page.

1. Select the image.
  - In the Notes and Question applications, click the image to select it.
  - In the Graphs & Geometry and Data & Statistics applications, right-click the image, and then click **Select > Image**.
2. Click the selected image and hold the mouse button.
  - If an image is in the foreground, the cursor changes to .
  - If an image is in the background, the cursor changes to .

3. Drag the image to the new location and release the mouse button to place the image.

If an image is in the foreground, the cursor changes to  when you hover your mouse pointer over a location where there is a new line or space. Images in the background can be moved and placed anywhere on the page.

## Resizing Images

To retain the aspect ratio of an image, resize by grabbing the image at one of the four corners.

1. Select the image.
  - In the Notes and Question applications, click the image to select it.
  - In the Graphs & Geometry and Data & Statistics applications, right-click the image, and then click **Select > Image**.
2. Move the cursor to one of the corners of the image.

The cursor changes to  (a four-sided directional arrow).

**Note:** If you drag the cursor to an edge of the image, the cursor

changes to  (a two-sided directional arrow). If you drag an image from one of its edges to resize it, the image becomes distorted.

3. Click the corner or edge of the image.

The  tool is enabled.

4. Drag in to make the image smaller or drag out to make the image larger.
5. Release the mouse when the image size is correct.

## Deleting Images

To delete an image from an open document, complete the following steps.

1. Select the image.
  - If an image is in the foreground, click the image to select it.
  - If an image is in the background, right-click the image, and then click **Select > Image**.
2. Press **Delete**.

The image is removed.



# Using the Script Editor

The Script Editor allows you to create and deliver dynamically linked simulations, powerful and flexible utilities, and other educational content for exploring math and science concepts. When you open a document containing a script, the script runs automatically as programmed. To see the running script application, the page containing the script application must be active.

The Script Editor is directed toward teachers and other authors who are comfortable working in a Lua scripting environment. Lua is a powerful, fast, lightweight scripting language that is fully supported in TI-Nspire™ and PublishView™ documents. Documents containing script applications can be opened on TI-Nspire™ handhelds and in the TI-Nspire™ Document Player. The script application runs on a handheld or in Document Player, but you cannot view or edit the script.

Note these resources for using the Script Editor and creating scripts:

- Press **F1** to access the TI-Nspire™ help, which includes the Script Editor help.
- Press **F2** for additional TI-Nspire™ resources such as scripting samples and a link to the TI-Nspire™ Scripting API library. (This information is also available at [education.ti.com/nspire/scripting/home](http://education.ti.com/nspire/scripting/home).)
- Go to [lua.org](http://lua.org) for more information about Lua.

## Overview of the Script Editor

With the Script Editor, you can insert, edit, save, run, and debug script applications in TI-Nspire™ (.tns files) and Publishview™ (.tnsp files) documents.

- Script applications function within documents, problems, and pages the same way that other TI-Nspire™ applications do.
- When you create a new document or open an existing document, you can insert or edit a script application within a page or within a work area of a split page.
- In a split page layout, you can add a script application to each work area of a page. A page can be split into a maximum of four quadrants.
- Images can be added to script applications. See the *Inserting Images* section.
- All work done in the Script Editor is lost if you close the TI-Nspire™ or PublishView™ document without saving it.

## Exploring the Script Editor Interface

The Script Editor window opens when you insert a new script application or edit an existing script application in a TI-Nspire™ or PublishView™ document.

Select options for creating new scripts or editing scripts from the Insert menu in the Documents Workspace when a document is open.

**Note:** Although not labeled, the Documents Workspace is the default workspace in the TI-Nspire™ Student Software and TI-Nspire™ CAS Student Software.

The following figure shows the Script Editor with an existing script.

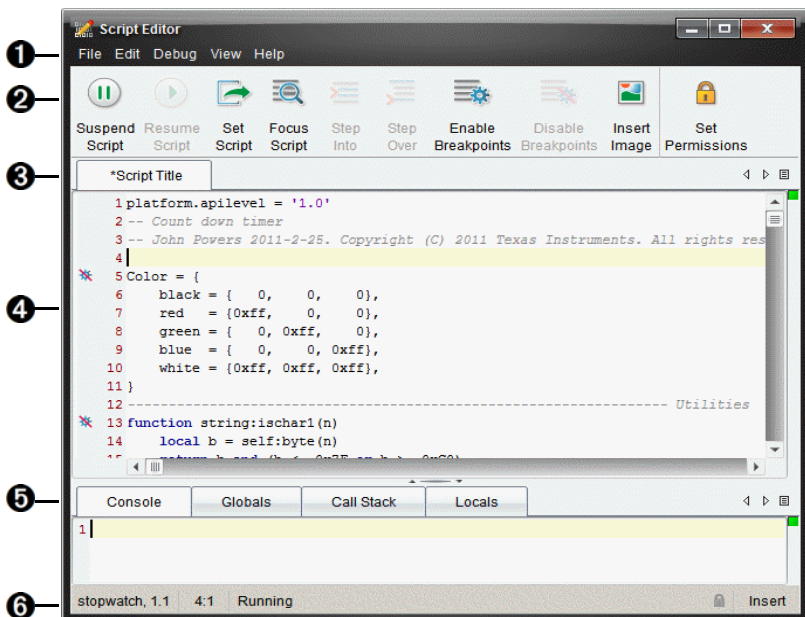











- 1 Menu bar.** Contains options for working with the Script Editor.
- 2 Toolbar.** Provides tools for common Script Editor functions. See the *Using the Toolbar* section.
- 3 Script title.** You can change the title from the menu, or right-click the title to change it.
- 4 Script lines.** Type your text in the script lines. This script shows several disabled breakpoints, which are indicated by slashes.

- 5 **Tools panel.** Area of the window where the script data is stored. See the Using the Tools Panel section.
- 6 **Status bar.** Displays the operational state of the script. See the Using the Status Bar section.

## Using the Toolbar

The following table describes the toolbar options.

Tool name		Tool function
	Suspend Script	Pauses the script execution.
	Resume Script	Resumes the script execution. While debugging, the script continues to execute until the next breakpoint or the end of the script.
	Set Script	Starts the script execution.
	Focus Script	Sets the focus to the page in the document where the script application is attached: <ul style="list-style-type: none"> <li>• In a TI-Nspire™ document, sets the focus to the page.</li> <li>• In a PublishView™ document, sets the focus to the frame on the page.</li> </ul>
	Step Into	While debugging, executes the current statement. If the statement calls any functions, the debugger stops at the first line of each function.
	Step Over	While debugging, executes the current statement. If the statement calls any functions, the debugger does not stop within the function unless the function contains a breakpoint.
	Enable Breakpoints	Switches from normal mode to debugging mode.
	Disable Breakpoints	Switches back from debugging mode to normal mode and resumes the script.

Tool name		Tool function
	Insert Image	Inserts the image in a string format into the current script at the cursor location.
	Set Permissions	Sets permission levels to Protected, View Only, or Unprotected and allows you to set a password for the script.

## Using the Tools Panel

At the bottom of the window, the Tools panel shows the scripting data. For more information, see the *Debugging Scripts* section.

Tab	Window Display
Console	Script errors are printed here. Print statements embedded in the script also print here.
Globals	Selected global variables are displayed. To select a global variable for display, select <b>Click to add new watch variable</b> at the bottom of the Tools panel.
Call Stack	Displays the call tree for the currently executing function.
Locals	Local variables in the current function's scope are displayed.

## Using the Status Bar

The status bar at the bottom of the window shows basic script data, as described in this example: `stopwatch, 1.1 4:1 Running`.

- Name of the document that the script application is attached to (`stopwatch`)
- Problem and page number (`1.1`)
- Script line and character, (`4:1` describing line 4 and character 1)
- Operational state of the script (`Running`). Note the possible states:
  - Normal mode: `Running`, `Paused`, or `Error`
  - Debugging mode: `Running (debugging)`, `Paused`, `Stepping`, or `Error`

## Inserting New Scripts

To insert a new script application and script, follow these steps.



1. Open the document where you want to insert the script. It can be a new or existing document.

2. Click **Insert > Script Editor > Insert Script**.

A script application is inserted, and the Script Title dialog box opens.

**Note:** The TI-Nspire™ Student Software and the TI-Nspire™ CAS Student Software open automatically within the Documents Workspace.

3. Type a script title. (The maximum number of characters is 32.)

4. Click **OK**.

The Script Editor window opens showing a blank script.

5. Type your text in the script lines.

**Note:** Some nonstandard UTF-8 wide characters may not be displayed correctly. For these characters, it is highly recommended that you use the `string.uchar` function.

6. When the script is complete, click **Set Script** to execute it.

- In a TI-Nspire™ document, the script application is inserted in a new page. When the page containing the script application is active, the Documents Toolbox is empty.
- In a PublishView™ document, a frame containing the script application is added to the active page. You can move or size this frame just as you would any other PublishView™ object, and you can add other PublishView™ objects to the page.

7. To view the script application, click **Focus Script**.

## ***Editing Scripts***

To edit an existing script, follow these steps.

1. Open the TI-Nspire™ or PublishView™ document that contains the script. The page containing the script must be active.

2. Select the page and the work area that contains the script.

3. Click **Insert > Script Editor > Edit Script**.

The Script Editor opens showing the script. If the selected work area on the page does not contain a script, Edit Script is dimmed.

If the script is password protected, the Password Protected dialog box opens prompting for a password.

4. Make any desired changes.

- To designate comments, use double hyphens (--) at the start of each comment line.
- To change the title, click **Edit > Set Script Title** or right-click the title and click **Set Script Title**.

**Notes:**

- Some nonstandard UTF-8 characters may not be displayed correctly. For these characters, it is highly recommended that you use the `string.uchar` function.
  - The `print` function may yield unexpected results for non-UTF-8 characters.
  - Some nonprintable characters returned by the `on.save` function will be discarded.
5. To execute the script, click **Set Script**.  
Any errors are displayed in the Console area in the Tools panel.
  6. To view the script application (running script), click **Focus Script**.

## ***Saving Script Applications***

Clicking **Set Script** resets (updates) a script application in a TI-Nspire™ or PublishView™ document. However, the script and script application are not saved until you save the document. If you close the document or close the TI-Nspire™ software without saving, work on the script is lost.

To ensure the script application is saved after all work is complete, follow these steps.

1. From the Script Editor window, click **Set Script** to reset (update) the script application in the document.
2. From an open document, click **File > Save Document** to save changes to the TI-Nspire™ or PublishView™ document.

**Note:** To ensure work is backed up, set the script and save the document frequently.

## ***Inserting Images***

To insert an image into a script application, follow these steps.

1. Position your cursor where you want the image serialization to be located in the script.

- Using the example that follows, type the code for the image.

```
<myImage> = image.new (<image serialization>)  
function on.paint(gc)  
  gc.drawImage (<myImage>, 30, 30)  
end
```

- At `<image serialization>`, click **File > Insert Image**.

A dialog box opens prompting you to navigate to the appropriate image file. The supported file types are .jpg, .jpeg, .bmp, and .png.

**Note:** To avoid slow editor performance, keep the image height plus width at less than 640 pixels.

- Navigate to the image file that you want to insert.

The Script Editor reformats the image to a string format that the script image APIs understand. For more information about using images, see the API library.

- To execute the script, click **Set Script**.
- To view the simulation with the new image, click **Focus Script**.

## Changing View Options

To change viewing options:

- ▶ To clear the scripting data in the Tools panel and restore the editor defaults, click **View > Restore Editor to Defaults**.
- ▶ To view the script title in the document and before each print statement in the Console, click **View > Title in Document View**.
- ▶ To hide or show toolbar labels, click **View > Toolbar Text Labels**.
- ▶ To show or hide the Tools panel or its areas, click **View > Tools Panel** and click the appropriate option.
- ▶ To create tab groups when multiple scripts are open, right-click one of the titles and click **New Horizontal Group** or **New Vertical Group**.

## Setting Script Permissions

You can set permission levels for a script and specify a password to protect a script. Follow these steps.

- In the Script Editor window, click **File > Set Permissions**.  
The Set Permissions dialog box opens.
- In the Permissions Level area, select the appropriate security level:
  - **Protected**. The script can be run, but not viewed or edited.

- **View only.** The script can be viewed, but not edited.
  - **Unprotected.** The script can be viewed and edited.
3. To secure a script, designate a password in the Security area.
- Note:** Use caution when setting passwords because they cannot be recovered.
4. Click **OK**.

The next time you click **Insert > Script Editor > Edit Script**, a Password Protected dialog box opens prompting for the password. Choose one of these options:

- To edit the script, enter the password and click **OK**.
- To view the script only, do not enter the password and click **View**.

## **Debugging Scripts**

You can debug your script to investigate runtime errors and trace the execution flow. While debugging, data is displayed in the Tools panel.

- ▶ To enable debugging mode or disable it and return to normal mode, click **Debug > Enable Breakpoints** or **Disable Breakpoints**.

**Note:** Disabling breakpoints always resumes the script execution.

- ▶ While debugging, click **Step Into** and **Step Over** as appropriate. See the *Exploring the Script Editor interface* section.
- ▶ To set breakpoints, double-click in the space to the far left of the line number. Breakpoints are disabled until you click **EnableBreakpoints**.
- ▶ Note these factors when debugging:
  - Breakpoints in coroutines are not supported.
  - If a breakpoint is set in a function that is a callback, the debugger may not stop at the breakpoint.
  - The debugger may not stop at functions such as `on.save`, `on.restore`, and `on.destroy`.

On the toolbar, Step Into and Step Over are enabled when breakpoints are enabled.

- ▶ To suspend and resume the script execution, click **Suspend Script** and **Resume Script**. When the script resumes, it runs until the next breakpoint is encountered or to the end of the script. A script can be suspended in normal mode or debugging mode.

# Regulatory Information

## **Warning Statements**

**Warning!** Install the TI-Nspire™ Navigator™ Access Point in such a manner as to maintain a minimum of 20 cm (7.9 inches) separation distance between the radiating element(s) and all persons. This safety warning conforms to FCC radio frequency exposure limits.

**Warning!** Do not touch or move the TI-Nspire™ Navigator™ Access Point when the antennas are transmitting or receiving.

**Warning!** The TI-Nspire™ Navigator™ Access Point, TI-Nspire™ Navigator™ Cradle, and TI-Nspire™ CX Wireless Network Adapter are intended for indoor use only. Do not install the device nor operate it outdoors.

**Warning!** Intentional radiators, such as the TI-Nspire™ Navigator™ Access Point, TI-Nspire™ Navigator™ Cradle, and TI-Nspire™ CX Wireless Network Adapter are not intended to be operated with any antenna(s) other than those furnished by Texas Instruments. An intentional radiator may only be operated with the antenna(s) with which it is authorized.

**Warning!** Only qualified personnel must perform installation. Read and follow all warning notices and instructions marked on the product or included in the documentation.



## ***Texas Instruments Support and Service***

### **For U.S. and Canada:**

#### **For General Information**

**Home Page:** [education.ti.com](http://education.ti.com)

**KnowledgeBase and e-mail inquiries:** [education.ti.com/support](http://education.ti.com/support)

**Phone:** (800) TI-CARES / (800) 842-2737  
For U.S., Canada, Mexico, Puerto Rico, and Virgin Islands only

**International information:** [education.ti.com/international](http://education.ti.com/international)

#### **For Technical Support**

**KnowledgeBase and support by e-mail:** [education.ti.com/support](http://education.ti.com/support)

**Phone (not toll-free):** (972) 917-8324

#### **For Product (Hardware) Service**

**Customers in the U.S., Canada, Mexico, Puerto Rico and Virgin Islands:** Always contact Texas Instruments Customer Support before returning a product for service.

#### **For All Other Countries:**

For general information

For more information about TI products and services, contact TI by e-mail or visit the TI Internet address.

**E-mail inquiries:** [ti-cares@ti.com](mailto:ti-cares@ti.com)

**Home Page:** [education.ti.com](http://education.ti.com)

#### ***Service and Warranty Information***

For information about the length and terms of the warranty or about product service, refer to the warranty statement enclosed with this product or contact your local Texas Instruments retailer/distributor.





# Index

## A

- access point
  - configuring 12
- account, teacher 21
- activities
  - copying 54
  - filtering 52
  - keyword searches 52
  - opening 52
  - saving 53
- Activities file 38
- ActivityTypes file 36
- adapter 1, 3
  - adding to network 13, 15, 16
  - connecting to handhelds 7
  - removing from network 16
- adding
  - (x,y) numerical input questions 166
  - applications 192
  - applications (PublishView™ documents) 220
  - classes 71
  - colors 188
  - copyrights 155
  - copyrights to documents (.tns) 200
  - drop points questions 169
  - equation questions 162
  - images in Quick Poll 297
  - images to pages 297
  - images to questions 158
  - links 49
  - lists questions 170
  - Master Documents 293
  - open response questions 161
  - pages 196
  - problems 196
  - questions 158, 160
  - shortcuts 47
  - students to classes 75
  - teacher equations to graphs 277
  - teacher points to graphs 276
  - text (PublishView™ documents) 232

- applications
  - adding 192
  - deleting 195
  - grouping 195
  - inserting images 297
  - Question 153
  - swapping 193
- arranging
  - captured screens 110
- aspect ratio
  - changing (Review Workspace) 262
- assignments
  - exporting 289
  - redistributing 293
  - removing 295
  - renaming 294
  - saving 285
  - viewing individual 284
  - viewing summary 282
- Attendance file 37

## B

- bar charts
  - organizing 265
  - viewing (Review Workspace) 256
- batteries
  - charging 3
- beginning class sessions 82
- borders (PublishView™ documents),
  - hiding/showing 228

## C

- Capture Class
  - printing screens 116
  - saving screens 115
  - view options 109
- capture class tool 106
- capture page option 118
- Capture Selected Handheld option 119
- captured screens
  - rearranging 110
  - refreshing 110
- capturing
  - active pages in documents 118
  - handheld current screens 105

- images in handheld mode *105*
- pages in active documents *105*
- screen stacks *113*
- student handhelds *106*
- capturing images
  - DragScreen *123*
- changing
  - class views *83*
  - colors *264*
  - General Settings *147*
  - Graphs & Geometry settings *149*
  - language *33*
  - links *49*
  - passwords *101*
  - scores *289*
- charging
  - batteries *3*
  - cradles *3*
- Class Record *89*
  - canceling file transfers *100*
  - checking file transfer status *100*
  - viewing file properties *101*
- Class Session file *37*
- class sessions
  - beginning *82*
  - ending *82*
- Class Workspace *71*
- classes
  - adding classes *71*
  - adding students *75*
  - assigning students *85*
  - changing views *83*
  - Class Record *71, 89*
  - copying student information *89*
  - creating classes *71*
  - moving students to *88*
  - removing classes *80*
  - removing students from *77*
  - seating charts *83*
  - sending files *54*
  - student lists *83*
- clearing
  - Live Presenter keypress history *134*
- closing
  - Live Presenter *137*
- closing documents (.tns) *186*
- collecting
  - files *94*
  - missing files *294*
- colors
  - changing for student responses *264*
- colors, adding *188*
- comparing
  - screens *114*
- configuring
  - access point *12*
- configuring plot lists *262*
- connecting
  - handhelds to cradles *8*
  - handhelds to wireless adapters *7*
- content
  - viewing on handhelds *57*
- Content Explorer *143*
- Content Workspace *41*
- content workspace
  - exploring *41*
- converting
  - .tns files to .tnsp files *246*
  - .tnsp files to .tns files *245*
  - text to hyperlinks *240*
- copying
  - activities *54*
  - handheld images *105*
  - images *118*
  - images in handheld mode *105*
  - Live Presenter keypress history *134*
  - screens *122*
  - student information *89*
- copying problems *196*
- copyrights
  - adding *155*
  - adding to documents (.tns) *200*
  - viewing in documents (.tns) *198*
- cradles
  - adding to network *13, 16*
  - charging *3*
  - checking LEDs *4*
  - connecting to handhelds *8*
  - removing from network *16*
- creating
  - classes *71*
  - passwords *103*
  - PublishView™ documents *204*

SessionLogs folder 35  
creating documents (.tns) 183

## D

### data

viewing in tables (Review  
Workspace) 257  
viewing student responses 260

### deleting

applications 195  
classes 80  
documents (.tns) 186  
files (Portfolio Workspace) 295  
hyperlinks (PublishView™  
documents) 240  
images 299  
images (PublishView™  
documents) 242  
keypress history in Live Presenter  
134  
pages 195  
problems 197  
PublishView™ objects 219  
shortcuts 48  
student information 77

### displaying

student responses 253  
teacher handhelds 108

### document

settings 32

### documents

creating .tnsp files 204  
printing .tnsp files 247  
saving .tnsp files 209

documents (.tns, .tnsp)  
opening (Content Workspace) 52

### documents (.tns)

changing General Settings 147  
closing 186  
creating 183  
deleting 186  
opening 61, 186  
opening (Class Workspace) 258  
opening (Portfolio Workspace)  
259  
printing 197  
properties 198

protecting 199  
read-only 199  
saving 61, 185, 186  
switching between 189  
types 183  
viewing 189

Documents Workspace 139  
DragScreen feature 105, 123  
drop points questions  
adding 169

## E

### editing

scores 288, 289

emulator, *See TI-SmartView™  
emulator*

ending class sessions 82

equation questions  
adding 162

### exploring

content workspace 41  
resources pane 42

### exporting

data 289  
student scores (Portfolio  
Workspace) 289

## F

### features

refreshing screen captures 111

### files

canceling transfers 100  
checking transfer status 100  
collecting 94  
collecting missing 294  
image file types 297  
importing (Portfolio Workspace)  
286  
previewing (Portfolio  
Workspace) 287  
properties 101  
redistributing (Portfolio  
Workspace) 293  
removing (Portfolio Workspace)  
295  
saving (Portfolio Workspace)  
278, 285

- sending *54, 91*
- sending missing *294*
- viewing properties *101*
- working with files on connected handhelds *59*
- filtering activities *52*
- final scores, changing *289*
- Flash (.flv) files *243*
- folders
  - storing PublishView™ objects *219*
- footers in PublishView™ documents *227*
- formatting
  - text (PublishView™ documents) *233*
- formatting text *187*
- formatting toolbar
  - hiding *188*
  - showing *188*

## **G**

- Gallery view *109*
- graphs
  - adding teacher equations *277*
  - adding teacher points *276*
  - viewing data (Review Workspace) *256*
- Graphs & Geometry settings *149*
- grouping
  - responses *266*
- grouping applications *195*

## **H**

- handhelds
  - capturing current screens *105*
  - capturing selected handhelds *119*
  - capturing student screens *106*
  - checking for OS updates *64*
  - connecting to adapters *7*
  - connecting to cradles *8*
  - copying images *105*
  - installing OS update *66*
  - locating using Identify Selected *69*
  - pasting images *105*

- renaming *68*
- software *5*
- transferring files *64*
- viewing content on connected handhelds *57*
- working with files on connected handhelds *59*
- headers in PublishView™ documents *227*
- hiding
  - handheld display in Live Presenter *131*
  - Live Presenter keypad history *133*
  - presenter handheld *131*
  - responses *253, 267, 268*
  - student names *108*
  - student names in Live Presenter *130*
- hiding format toolbar *188*
- hyperlinks (PublishView™ documents)
  - converting text to *240*
  - editing *239*
  - linking to files *235*
  - linking to websites *238*

## **I**

- Identify Selected *69*
- images
  - adding to questions *158*
  - deleting *299*
  - file types *297*
  - inserting *297*
  - moving *298*
  - Quick Poll *297*
  - resizing *299*
  - saving *105, 118*
  - selecting *298*
  - TI-Nspire™ applications *297*
- images (PublishView™ documents) *240–242*
- importing files (Portfolio Workspace) *286*
- inserting
  - hyperlinks (PublishView™ documents) *235*

- images (PublishView™ documents) 241
- images in questions 158
- images in Quick Poll 297
- images to pages 297
- PublishView™ objects 215
- text (PublishView™ documents) 232

installing a handheld OS update 66

installing handheld software 5

inventory 2

## **K**

keypress history

- copying 134
- hiding in Live Presenter 133
- Live Presenter 130
- showing in Live Presenter 133
- viewing in Live Presenter 132

keyword searches 52

## **L**

language

- changing 33

LED

- cradles 4, 20
- status on cradles 4

linking

- to files 235
- to websites 238

links 48

- adding 49
- changing 49
- moving 50
- removing 50

lists

- organizing data 265

lists questions

- adding 170

Live Presenter 127

- clearing keypress history 134
- copying keypress history 134
- Display pane 130
- Handheld pane 130
- hiding keypress history 133
- hiding presenter handheld 131
- hiding student names 130

- hiding the handheld display 131
- keypress history 130
- Menu bar 129
- playing a recording 136
- recording the live presentation 135
- requirements 127
- save recording 135
- sharing recordings 136
- showing keypress history 133
- showing presenter handheld 131
- showing student names 130
- showing the handheld 132
- showing the handheld screen 134
- start recording 135
- starting 127
- starting from Class Screen capture 127
- stop recording 135
- stopping 137
- Tool bar 129
- View options 130
- viewing keypress history 132

Live Presenter keypress history

- clearing 134

live results 255

logging in to network 24

logging system use

- session logs 35

login status 84

## **M**

Make Presenter option 115

managing

- session logs 36

marking responses 270

Master Documents 292

moving

- images 298
- images (PublishView™ documents) 242
- links 50
- PublishView™ objects 217
- students to classes 88

multiple choice questions

- adding 160

## **N**

### network

- logging in 24
- setting up 10

### numerical input questions

- adding 166

## **O**

### objects

- (PublishView™ documents) 214–220

### open response questions

- adding 161

### opening

- activities 52
- documents (.tns) 61
- Master Documents 292
- Portfolio items 291

### opening documents (.tns) 186

### options

- capture page 118
- Capture Selected Handheld 119
- Make Presenter 115
- randomize screens 108

### organizing

- bar chart data 265, 266
- list data 265
- responses 262, 267

### organizing PublishView™ sheets 226

### OS update

- installing on a handheld 66

### overlapping PublishView™ objects

- 218

### overview

- software 29
- TI-Nspire(TM) Navigator(TM)
- Teacher Software 29

## **P**

### packaging session logs 38

### page numbers (PublishView™ documents) 227

### Page Sorter 141, 193, 251

### pages

- adding 196
- deleting 195

### grouping 195

### rearranging 194

### selecting 194

### ungrouping 195

### panes

- resource 42

### passwords

- changing for teacher 22
- resetting for students 101
- setting 103

### pasting

- handheld images 105
- images 118
- images in handheld mode 105
- screens 122

### pasting problems 196

### playing

- Live Presenter recording 136

### plots

- configuring lists 262

### points

- adding to graphs (Review Workspace) 276

### polling students 178

### polls

- stopping 178
- viewing results 180

### Portfolio Workspace 281

### print preview 198

### printing

- captured screens 116
- PublishView™ documents 247

### printing documents (.tns) 197

### problems

- adding 196
- copying/pasting 196
- deleting 197
- renaming 197

### problems (PublishView™ documents) 224–226

### protecting documents (.tns) 199

### PublishView™ documents 203

### applications 220–223

### converting 244–246

### creating 204

### hyperlinks 234–240

### images 240–242

### objects 214, ??–219

- printing 247
- problems 224–226
- saving 209
- sheets 226–231
- text 232–234
- video files 242

## Q

questions

- (x,y) numerical input 166
- adding 158
- adding images 158
- drop points 169
- equation 162
- lists 170
- multiple choice 160
- open response 161
- Self Check mode 161
- suggested responses 162
- using the Question application 153

Quick Poll

- images 297
- opening 176
- polling students 178
- saving polls 180
- stopping polls 178
- viewing results 180

## R

- randomize screen option 108
- read-only documents (.tns) 199
- rearranging
  - captured screens 110
- recording
  - Live Presenter presentation 135
  - starting Live Presenter recording 135
- redistributing assignments 293
- refreshing
  - captured screens 110
- removing
  - classes 80
  - files 295
  - hyperlinks from text 240
  - images 299
  - links 50

- students from classes 77
- removing adapters or cradles from network 16
- renaming
  - items (Portfolio Workspace) 294
  - problems (PublishView™ documents) 225
- renaming problems 197
- reponses
  - adding suggested 162
- reporting system use 35
- repositioning images 298
- requirements
  - Live Presenter 127
- resetting student passwords 101
- resizing
  - images 299
  - images (PublishView™ documents) 242
  - PublishView™ objects 217
- resources pane
  - exploring 42
- responses
  - hiding 267
  - marking 270
  - organizing 262
  - showing 267, 270
  - showing correct 255
  - sorting 258
- Review tools 250
- Review Workspace 249

## S

- saving
  - activities to your computer 53
  - captured images 105
  - captured pages 121
  - data as new document (Review Workspace) 279
  - documents (.tns) 61
  - files to Portfolio Workspace 278
  - handheld screens 121
  - images 118
  - Live Presenter recording 135
  - Portfolio items 285
  - PublishView™ documents 209
- saving documents (.tns) 185, 186

- scaling 32
- scores, editing 288
- screen capture tool 106
- screen captures
  - Capture Class 105
  - comparing screens 114
  - copying 122
  - Gallery view 109
  - hiding student names 108
  - Make Presenter option 115
  - pasting 122
  - showing student names 108
  - stacks 113
  - teacher preferences 108
  - Tiled view 109
  - zoom percentages 112
  - zooming in/out 112
- screen stacks 113
- screens
  - comparing 114
- searching for activities 52
- seating charts 83, 84
- selecting
  - images 298
  - working folder (PublishView™ objects) 219
- selecting pages 194
- self-check
  - document types 156
- Self-Check mode 161
- sending
  - files to class 54, 91
  - missing files 294
- sending session logs 38
- session logs
  - Activities 38
  - activity types 36
  - Attendance file 37
  - Class Session 37
  - packaging 38
  - sending 38
- setting
  - zoom percentages 112
- setting up
  - network 10
- settings
  - teacher preferences 83
- sharing
  - Live Presenter recording 136
- shortcuts 47, 48
- showing
  - correct responses 255
  - handheld in Live Presenter 132
  - Live Presenter handheld screen 134
  - Live Presenter keypress history 133
  - presenter handheld 131
  - responses 267
  - student names 108
  - student names in Live Presenter 130
  - student responses 253, 270
- showing format toolbar 188
- software
  - overview 29
- sorting
  - Portfolio items 291
  - responses 258
  - student information 85
- Starting
  - Live Presenter from Class Screen Capture 127
- starting
  - Live Presenter 127
  - Live Presenter recordings 135
- status
  - of file transfers 100
- stopping
  - Live Presenter 137
  - Live Presenter recording 135
  - polls 178
- student handhelds
  - capturing 106
- student responses
  - individualizing 264
  - marking correct/incorrect 270
  - organizing 262
  - showing/hiding 267, 270
  - viewing 252
- students
  - adding to classes 75
  - arranging in seating charts 84
  - changing classes 85
  - changing names 87
  - changing student IDs 87



- checking login status *84*
- copying information *89*
- creating passwords *103*
- deleting information *77*
- displaying responses *253*
- moving information *88*
- polling *178*
- removing from classes *77*
- resetting passwords *101*
- responses *253*
- setting passwords *103*
- viewing student list *83*

suggested response *156*

## T

teacher

- add to classroom view *21*

teacher account *21*

- changing password *22*
- changing user name *23*

teacher data, adding *276, 277*

teacher handhelds

- displaying *108*

teacher preferences *83*

Teacher Tool Palette *155*

text formatting *187*

Tiled view *109*

TI-Nspire(TM) Navigator(TM)

- Teacher Software
- overview *29*

TI-Nspire(TM) Screen Capture Window *120*

- zooming in/out *120*

TI-Nspire™ CX Wireless Network Adapter *1, 3*

- adding to network *13, 15, 16*
- connecting to handhelds *7*
- removing from network *16*

TI-Nspire™ Navigator™ Cradle

- adding to network *13, 16*
- checking the LED *4*
- removing from network *16*

TI-Nspire™ SmartView Emulator

- capturing images *123*

TI-SmartView™

- capturing images *105*
- DragScreen feature *105*

TI-SmartView™ emulator toolbar

- text formatting *187*

tools

- capture class *106*
- screen capture *106*

tools menu *30*

tracking system use *35*

transferring files

- canceling *100*
- checking transfer status *100*

transferring files to connected handhelds *64*

## U

ungrouping

- applications *195*
- pages *195*

user name, changing for teacher *23*

Using the Preview Pane *44*

## V

videos (PublishView™ documents)

- inserting files *243*
- video console *244*

view options

- Live Presenter *130*

viewing

- answers *260*
- assignment summaries *282*
- bar charts/graphs (Review Workspace) *256*
- capture class options *109*
- captured screens *120*
- copyrights *198*
- data (Review Workspace) *256, 257*
- documents (.tns) *147, 189*
- individual assignments *284*
- Live Presenter keypress history *132*
- live results *255*
- poll results *180*
- student responses *252, 260*

views

- handheld/computer modes *147*
- seating chart *83*

student list *83*  
table (Review Workspace) *257*

## **W**

Welcome Screen *27*  
  navigating *28*  
  opening *29*  
windows  
  TI-Nspire(TM) Screen Capture  
    *120*  
wireless adapter *1, 3*  
  adding to network *13, 15, 16*  
  connecting to handhelds *7*  
  removing from network *16*  
workspaces *30, 33*  
  Class Workspace *71*  
  Content Workspace *41*  
  Documents Workspace *139*  
  exploring *41*  
  Portfolio Workspace *281*  
  Review Workspace *249*

## **Z**

zoom percentages *112*  
zooming  
  in/out *112, 120*  
  PublishView™ documents *231*