

***GETTING STARTED  
WITH THE CBR 2™  
SONIC MOTION DETECTOR***

***INCLUDING***

***5 STUDENT ACTIVITIES***



---

### **Important notice regarding book materials**

Texas Instruments and any third party contributors make no warranty, either express or implied, including but not limited to any implied warranties of merchantability and fitness for a particular purpose, regarding any programs or book materials and makes such materials available solely on an "as-is" basis.

In no event shall Texas Instruments or any third party contributor be liable to anyone for special, collateral, incidental, or consequential damages in connection with or arising out of the purchase or use of these materials, and the sole and exclusive liability of Texas Instruments, regardless of the form of action, shall not exceed the purchase price of this product. Moreover, Texas Instruments shall not be liable for any claim of any kind whatsoever against the use of these materials by any other party.

© 2004 Texas Instruments Incorporated. All rights reserved.

Permission is hereby granted to teachers to reprint or photocopy in classroom, workshop, or seminar quantities the pages in this work that carry a copyright notice. These pages are designed to be reproduced by teachers for use in their classes, workshops, or seminars, provided each copy made shows the copyright notice. Such copies may not be sold, and further distribution is expressly prohibited. Except as authorized above, prior written permission must be obtained from Texas Instruments Incorporated to reproduce or transmit this work or portions thereof in any other form or by any other electronic or mechanical means, including any information storage or retrieval system, unless expressly permitted by federal copyright law. Send inquiries to this address: Texas Instruments Incorporated; 7800 Banner Drive, M/S 3918; Dallas, TX 75251; Attention: Manager, Business Services

Activity 1 (*Graphing Your Motion*) and Activity 3 (*A Speedy Slide*) are used with permission from Vernier Software and Technology. These activities were adapted from *Middle School Science with Calculators* by Don Volz and Sandy Sapatka.

# Table of contents

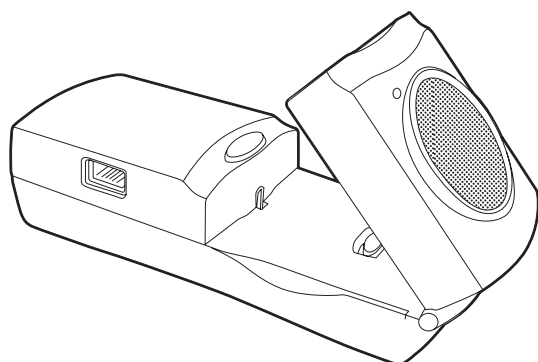





---

## Introduction

What is the CBR 2™ Sonic Motion Detector?	2
Getting started with the CBR 2™ Sonic Motion Detector	4
Hints for effective data collection	6

---

## Activities with teacher notes and student activity sheets

 Activity 1 — Graphing your motion	linear	10
 Activity 2 — Match the graph	linear	14
 Activity 3 — A Speedy slide	parabolic	18
 Activity 4 — Bouncing ball	parabolic	24
 Activity 5 — Rolling ball	parabolic	28
Teacher information		32

---

## Technical information

Sonic motion detector data is stored in lists	36
EasyData settings	37
Using a CBR 2™ Sonic Motion Detector with a CBL 2™ System or with CBL 2™ System programs	38

---

## Service information

Batteries	40
In case of difficulty	41
EasyData menu map	42
TI service and warranty	43

---

# ***What is the CBR 2™ Sonic Motion Detector?***

## ***CBR 2™ (Calculator-Based Ranger™)***

**sonic motion detector**

**use with TI-83 Plus, TI-83 Plus Silver Edition,  
TI-84 Plus, and TI-84 Plus Silver Edition**

**bring real-world data collection and analysis into the classroom**

**easy-to-use**

### ***What does the CBR 2™ sonic motion detector do?***

With the CBR 2™ motion detector and a TI graphing calculator, students can collect, view, and analyze motion data without tedious measurements and manual plotting.

The CBR 2™ motion detector lets students explore the mathematical and scientific relationships between distance, velocity, acceleration, and time using data collected from activities they perform. Students can explore math and science concepts such as:

- motion: *distance, velocity, acceleration*
- graphing: *coordinate axes, slope, intercepts*
- functions: *linear, quadratic, exponential, sinusoidal*
- calculus: *derivatives, integrals*
- statistics and data analysis: *data collection methods, statistical analysis*
- Physics: *motion, use with dynamics tracks, pendulum analysis, position, velocity, acceleration*
- Physical Science: *motion experiments*

### ***What's in this guide?***

*Getting Started with the CBR 2™ Sonic Motion Detector* is designed to be a guide for teachers who do not have extensive calculator experience. It includes quick-start instructions for using the CBR 2™ motion detector, hints on effective data collection, and five classroom activities to explore basic functions and properties of motion. The activities (see pages 10–31) include many of the following:

- teacher notes for each activity, plus general teacher information
- step-by-step instructions
- a basic data collection activity appropriate for all levels
- explorations that examine the data more closely, including what-if scenarios
- suggestions for advanced topics appropriate for precalculus and calculus students
- a reproducible student activity sheet with open-ended questions appropriate for a wide range of grade levels

## What is the CBR 2™ Sonic Motion Detector? (cont.)

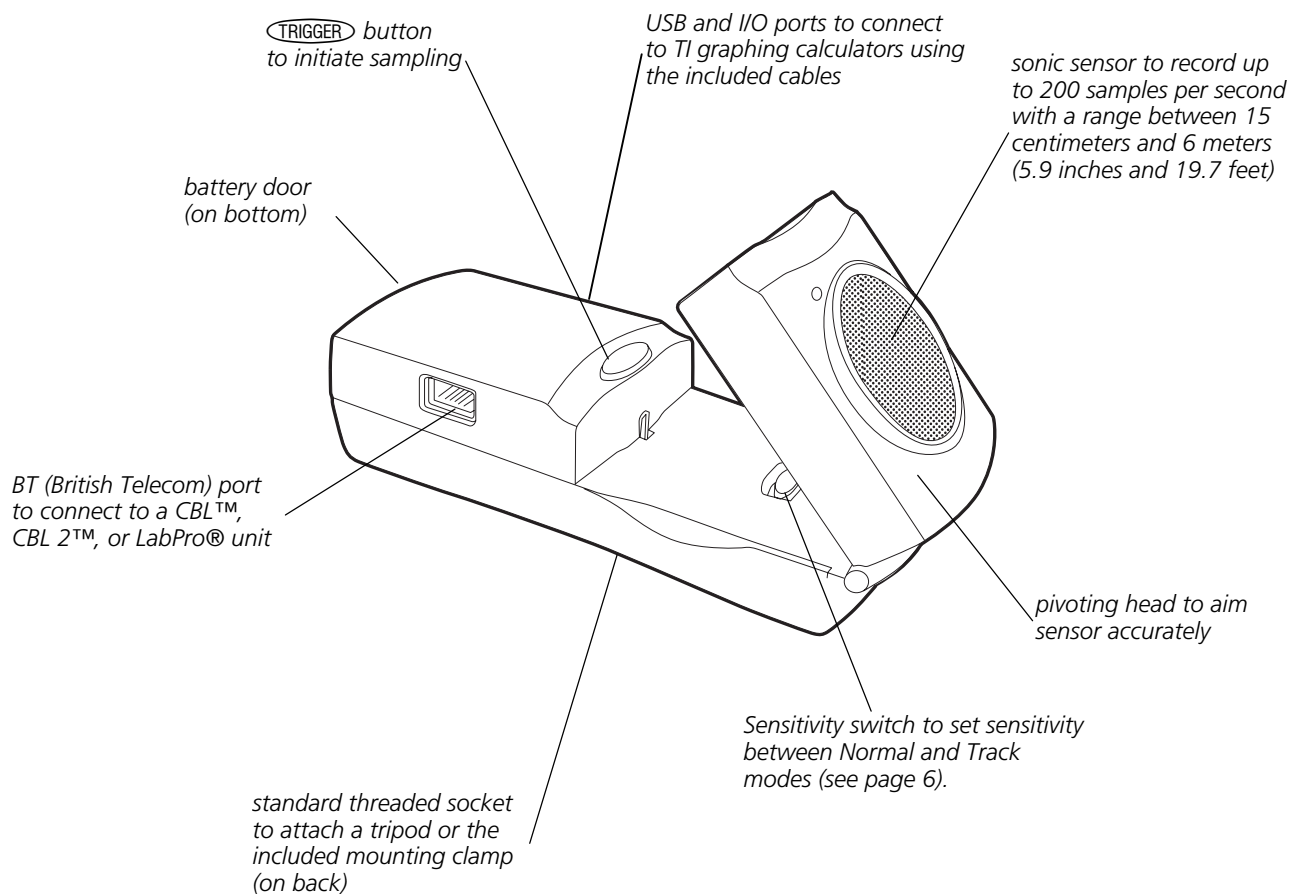

The CBR 2™ motion detector includes everything you need to begin classroom activities easily and quickly — just add TI graphing calculators (and readily available props for some activities).

- sonic motion detector
- 5 fun classroom activities
- 4 AA batteries
- Standard-B to Mini-A USB cable (unit-to-CBR 2™)
- I/O unit-to-unit cable

# Getting started with the CBR 2™ Sonic Motion Detector

With the CBR 2™ motion detector, you're just two or three simple steps from the first data sample!

## 1

### Download

Your graphing calculator may have been preloaded with a number of Apps (software applications), including the EasyData App. Press **[APPS]** to see the Apps installed on your calculator. If EasyData is not installed, you may find the latest version of this App at [education.ti.com](http://education.ti.com). If necessary, download the EasyData App now.

## 2

### Connect

Connect the CBR 2™ motion detector to your TI graphing calculator using the Standard-B to Mini-A USB cable (unit-to-CBR 2™) or I/O unit-to-unit cable, and push in firmly at both ends to make a secure connection.

Set the Sensitivity switch to Normal mode for walking, ball toss, pendulum, etc., or to Track mode for use with dynamics tracks and carts.

About the unit-to-CBR 2™ cable:

- Can only be used with the EasyData App.
- Provides for an auto-launch capability of the EasyData App when connecting a CBR 2™ motion detector to a TI-84 Plus-family calculator.
- Provides for an improved physical and more reliable connection than the I/O unit-to-unit cable.
- Cannot be used with RANGER, DataMate, or other similar applications.

## 3

### Run

Run the EasyData App on the graphing calculator connected to the CBR 2™ motion detector.

Proceed to step 1, if using a TI-83 Plus-family calculator. For the TI-84 Plus connected with a unit-to-CBR 2™ cable, perform steps 1 and 4.

1. Turn on the calculator and have it on the home screen.
2. Press **[APPS]** to display the list of Apps on your graphing calculator.
3. Choose EasyData and press **[ENTER]**.

The opening screen is displayed for about 2–3 seconds, and then the main screen is displayed.

4. Select Start (press **[ZOOM]**) in the main screen to start collecting data.

# Getting started with the CBR 2™ Sonic Motion Detector

For quick results, try one of the classroom-ready activities in this guide!

## **Important information**

- This guide applies to all TI graphing calculators that can be used with the CBR 2™ motion detector (see page 2); therefore, you may find that some of the menu names do not match exactly those on your calculator.
- When setting up activities, ensure that the CBR 2™ motion detector is securely anchored and that the cord cannot be tripped over.
- Always exit the EasyData App using the Quit option. The EasyData App performs a proper shutdown of the CBR 2™ motion detector when you choose Quit. This ensures that the CBR 2™ motion detector is properly initialized for the next time you use it.
- Always disconnect the CBR 2™ motion detector from the calculator before storing it.
- EasyData is launched automatically when the unit-to-CBR 2™ cable is connected from a TI-84 Plus or TI-84 Plus Silver Edition graphing calculator to a CBR 2™ motion detector.

# Hints for effective data collection

## Getting better samples

### How does the CBR 2™ sonic motion detector work?

Understanding how a sonic motion detector works can help you get better data plots. The motion detector sends out an ultrasonic pulse and then measures how long it takes for that pulse to return after bouncing off the closest object.

The CBR 2™ motion detector, like any sonic motion detector, measures the time interval between transmitting the ultrasonic pulse and the first returned echo, but the CBR 2™ motion detector has a built-in microprocessor that does much more. When the data is collected, the CBR 2™ motion detector calculates the distance of the object from the CBR 2™ motion detector using a speed-of-sound calculation. Then it computes the first and second derivatives of the distance data with respect to time to obtain velocity and acceleration data. It stores these measurements in lists.

### Object size

Using a small object at a far distance from the CBR 2™ motion detector decreases the chances of an accurate reading. For example, at 5 meters, you are much more likely to detect a soccer ball than a ping-pong ball.

### Minimum range

When the CBR 2™ motion detector sends out a pulse, the pulse hits the object, bounces back, and is received by the CBR 2™ motion detector. If an object is closer than 15 centimeters (about six inches), consecutive pulses may overlap and be misidentified by the CBR 2™ motion detector. The plot would be inaccurate, so position the CBR 2™ motion detector at least 15 centimeters away from the object.

### Maximum range

As the pulse travels through the air, it loses its strength. After about 12 meters (6 meters on the trip to the object and 6 meters on the trip back to the CBR 2™ motion detector), the return echo may be too weak to be reliably detected by the CBR 2™ motion detector. This limits the typical reliably effective distance from the CBR 2™ motion detector to the object to less than 6 meters (about 20 feet).

### Sensitivity switch

The sensitivity switch has two modes—Track and Normal. The Track mode is intended for activities using dynamics tracks and carts; the Normal mode is intended for all other activities, such as, walking, ball toss, bouncing ball, pendulum, etc.

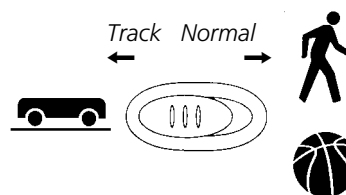

If you are getting lots of extra noise in your data, the sensitivity switch may be in the Normal mode. Moving the sensitivity switch to the Track position, will reduce the sensitivity of the sensor and may produce better data.



## Hints for effective data collection (cont.)

### The clear zone

The path of the CBR 2™ motion detector beam is not a narrow, pencil-like beam, but fans out in all directions up to 15° from center in a 30° cone-shaped beam.

To avoid interference from other objects in the vicinity, try to establish a *clear zone* in the path of the CBR 2™ motion detector beam. This helps ensure that objects other than the target do not get recorded by the CBR 2™ motion detector. The CBR 2™ motion detector records the closest object in the clear zone.

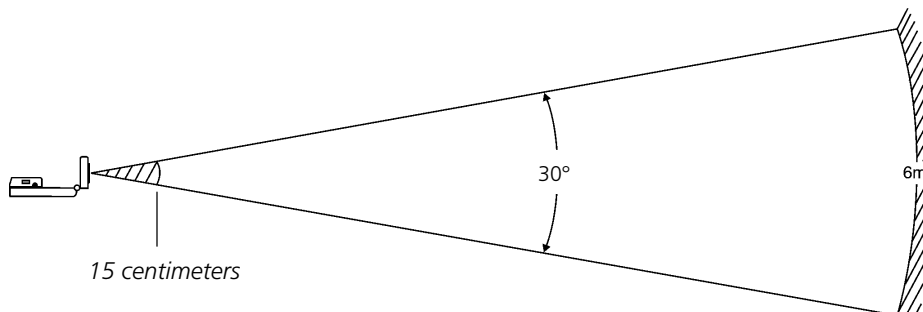

### Reflective surfaces

Some surfaces reflect pulses better than others. For example, you might see better results with a relatively hard, smooth surfaced ball than with a tennis ball. Conversely, samples taken in a room filled with hard, reflective surfaces are more likely to show stray data points. Measurements of irregular surfaces (such as a toy car or a student holding a calculator while walking) may appear uneven.

A Distance-Time plot of a nonmoving object may have small differences in the calculated distance values. If any of these values map to a different pixel, the expected flat line may show occasional blips. The Velocity-Time plot may appear even more jagged, because the change in distance between any two points over time is, by definition, velocity.

## Hints for effective data collection (cont.)

### EasyData settings

#### Setup data collection for Time Graph

Experiment length is the total time in seconds to complete all sampling. It's determined by the number of samples multiplied by the sample interval.

Enter a number between 0.05 (for very fast moving objects) and 0.5 seconds (for very slow moving objects).

**Note:** See "To set up the calculator for data collection" on page 12 for detailed information about how to change settings.

Menu name	Description	Default setting
Sample Interval	Measures time between samples in seconds.	0.05
Number of Samples	Total number of samples to collect.	100
Experiment Length	Length of the experiment in seconds.	5

#### Starting and stopping

To start sampling, select Start (press **ZOOM**). Sampling will automatically stop when the number of samples set in the Time Graph Settings menu is reached. The CBR 2™ motion detector will then display a graph of the sampled data on the graphing calculator.

To stop sampling before it automatically stops, select Stop (press and hold **ZOOM**) at any time during the sampling process. When sampling stops, a graph of the sampled data is displayed.

#### Noise—what is it and how do you get rid of it?

When the CBR 2™ motion detector receives signals reflected from objects other than the primary target, the plot shows erratic data points (noise spikes) that do not conform to the general pattern of the plot. To minimize noise:

- Make sure the CBR 2™ motion detector is pointed directly at the target. Try adjusting the sensor head while viewing live data on the home-screen meter. Make sure the reading you receive is appropriate before starting an activity or experiment.
- Try to sample in a clutter-free space (see the *clear zone* drawing on page 7).
- Choose a larger, more reflective object or move the object closer to the CBR 2™ (but farther than 15 centimeters).
- When using more than one CBR 2™ motion detector in a room, one group should complete a sample before the next group begins their sample.
- Try moving the sensitivity switch to the Track position to reduce the sensitivity of the sensor.

## ***Hints for effective data collection (cont.)***

### **Speed of sound**

The approximate distance to the object is calculated by assuming a nominal speed of sound. However, actual speed of sound varies with several factors, most notably the air temperature.

The CBR 2™ motion detector has a built-in temperature sensor to automatically compensate for changes in the speed of sound due to the temperature of the surrounding air. The temperature conversion from 0° to 40° Celsius, at standard pressure, is fairly linear at about +0.6 meters/second per degree Celsius. The speed of sound increases from about 331 meters/second at 0° Celsius to about 355 meters/second at 40° Celsius. These speeds assume a relative humidity of 35% (dry air).

When using the EasyData App with the CBR 2™ motion detector, this temperature compensation will take place when collecting motion data. The sensor is located underneath the holes on the back of the CBR 2™ motion detector; therefore, when collecting data, do not cover these holes with something that is of a different temperature from the surrounding ambient temperature.

### ***Using the CBR 2™ sonic motion detector without the EasyData application***

You can use the CBR 2™ unit as a sonic motion detector with a CBL 2™ system or with programs other than EasyData.

Using the I/O unit-to-unit cable, the CBR 2™ motion detector can be used with graphing calculators that do not have the EasyData App installed but do have the CBL/CBR App and/or the RANGER program. The CBR 2™ motion detector will provide the same functionality as a CBR™ motion detector when sample data is collected using the CBL/CBR App and/or the RANGER program.

The CBL/CBR App can be used on most older TI-83 Plus calculators. The CBL/CBR App is available for downloading at [education.ti.com](http://education.ti.com) and allows you to collect motion data using the I/O unit-to-unit cable on the CBR 2™ motion detector.

The RANGER program, which is part of the CBL/CBR App and available for other calculators, allows you to collect motion data using the I/O unit-to-unit cable. Many TI Explorations workbooks use the RANGER program.

You can also use CBR 2™ unit as a motion sensor with your CBL 2™ data collection device. Use the DataMate App that comes with the CBL 2™ system to operate the CBR 2™ motion detector through a CBL 2™ system. A special CBL-to-CBR cable is required to use this system. For more information about this cable visit the TI webstore at [education.ti.com](http://education.ti.com).

# Activity 1—Graphing your motion notes for teachers

## Concepts

Function explored: linear

This activity requires the EasyData App.

## Materials

- ✓ calculator (see page 2 for available models)
- ✓ CBR 2™ motion detector
- ✓ unit-to-CBR 2™ or I/O unit-to-unit cable
- ✓ EasyData application
- ✓ Masking tape
- ✓ Meter stick

## Hints

This experiment may be the first time your students use the CBR 2™ motion detector. A little coaching on its use now will save time later in the year as the CBR 2™ motion detector is used in many experiments. The following are hints for effective use of the CBR 2™ motion detector:

- In using the CBR 2™ motion detector, it is important to realize that the ultra sound is emitted in a cone about 30° wide. Anything within the cone of ultrasound can cause a reflection and possibly an accidental measurement. A common problem in using motion detectors is getting unintentional reflections from a desk or chair in the room.
- Often unintended reflections can be minimized by tilting the CBR 2™ motion detector slightly.
- If you begin with a velocity or acceleration graph and obtain a confusing display, switch back to a distance graph to see if it makes sense. If not, the CBR 2™ motion detector may not be properly targeting the target.
- The CBR 2™ motion detector does not properly detect objects closer than 15 cm. The maximum range is about 6 m, but stray objects in the wide detection cone can be problematic at this distance.

- Sometimes a target may not supply a strong reflection of the ultrasound. For example, if the target is a person wearing a bulky sweater, the resulting graph may be inconsistent.
- If the velocity and acceleration graphs are noisy, try to increase the strength of the ultrasonic reflection from the target by increasing the target's area.

You may want to have your students hold a large book in front of them as they walk in front of the CBR 2™ motion detector. This will produce better graphs because it smoothes out the motion.

## Typical plots

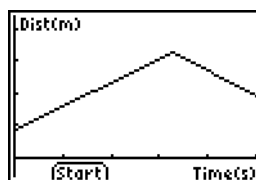

Distance vs. Time

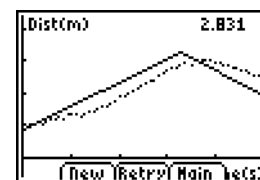

Matching Distance vs. Time

## Answers to questions

9. The slope of the portion of the graph corresponding to movement is greater for the faster trial.

Results will probably vary between groups as they may walk at different rates.

Walking towards the motion detector will produce a negative slope. While walking away from the motion detector will produce a positive slope.

12. Note that the slope is close to zero (if not zero) when standing still. The slope should be zero, but expect small variation due to the variation in collected data.

Graphs made using a CBR 2™ motion detector can be used to study motion. In this experiment, you will use a CBR 2™ motion detector to make graphs of your own motion.

## Objectives

In this experiment, you will:

- use a motion detector to measure distance and velocity
- produce graphs of your motion
- analyze the graphs you produce

## Data collection: Distance vs. Time Graphs

- 1 Place a CBR 2™ motion detector on a tabletop facing an area free of furniture and other objects. The CBR 2™ motion detector should be at a height of about 15 centimeters above your waist level.

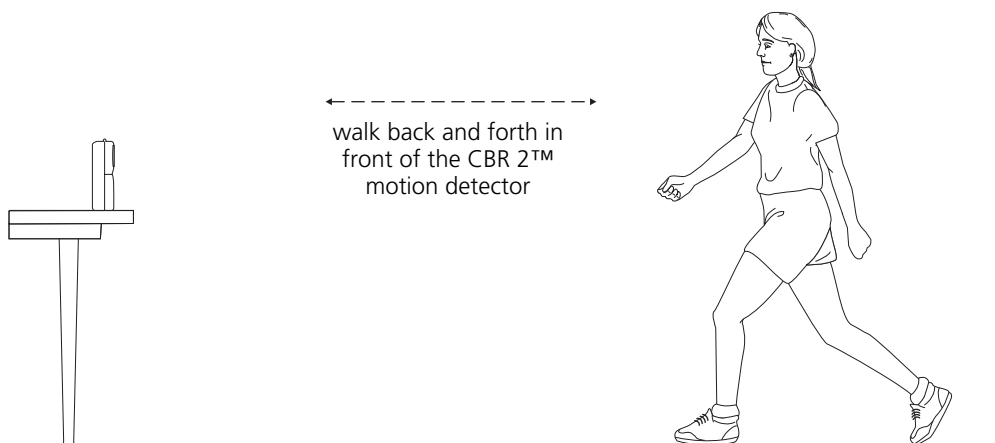

- 2 Use short strips of masking tape on the floor to mark the 1-m, 2-m, 3-m, and 4-m distances from the CBR 2™ motion detector.
- 3 Connect the CBR 2™ motion detector to the calculator using an appropriate cable (see below) and firmly press in the cable ends.
  - If TI-83 Plus, use an I/O unit-to-unit cable
  - If TI-84 Plus, use a Standard-B to Mini-A USB cable (unit-to-CBR 2™)
- 4 On the calculator, press **[APPS]** and select EasyData to launch the EasyData App.

**Note:** EasyData will launch automatically if the CBR 2™ motion detector is connected to a TI-84 Plus using a unit-to-CBR 2™ cable.

- 5 To set up the calculator for data collection:
  - a. Select Setup (press **WINDOW**) to open the Setup menu.
  - b. Press 2 to select 2: Time Graph to open the Time Graph Settings screen.
  - c. Select Edit (press **ZOOM**) to open the Sample Interval dialog window.
  - d. Enter 0.1 to set the time between samples to 1/10 second.
  - e. Select Next (press **ZOOM**) to advance to the Number of Samples dialog window.
  - f. Enter 50 to set the number of samples to collect.  
The experiment length will be 5 seconds (number of samples multiplied by the sample interval).
  - g. Select Next (press **ZOOM**) to display a summary of the new settings.
  - h. Select OK (press **GRAPH**) to return to the main screen.

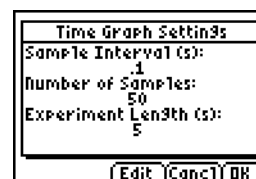
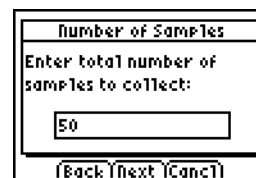
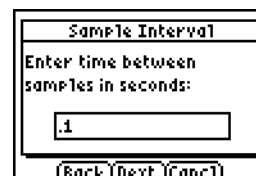
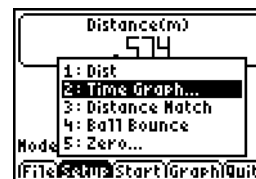

- 6 Explore making distance vs. time graphs.
  - a. Stand at the 1.0-m mark, facing away from the CBR 2™ motion detector.
  - b. Signal your partner to select Start (press **WINDOW**).
  - c. Slowly walk to the 2.5-m mark and stop.
  - d. When data collection ends, a graph plot is displayed.

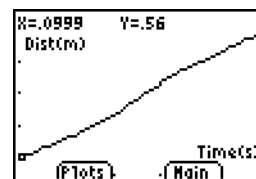

- e. Sketch your graph on the empty graph provided.
- f. Pick two points on the graph and determine the slope from the x and y-coordinates.

Point 1: \_\_\_\_\_ Point 2: \_\_\_\_\_ Slope: \_\_\_\_\_

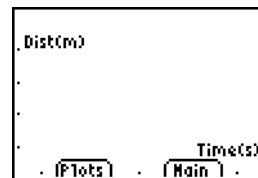

- g. Select Main (press **TRACE**) to return to the main screen.

- 7 Repeat Step 6, this time standing on the 2.5m-mark and walk towards the 1.0m-mark. One time walking slowly, and again walking more quickly.

Point 1: \_\_\_\_\_ Point 2: \_\_\_\_\_ Slope: \_\_\_\_\_

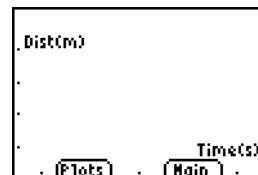

- 8 Sketch your new plots on the empty graph provided.
- 9 Describe the differences between your graphs (step 6e and step 8)

---



---



---

- 10 Repeat Step 6, while standing still on the 2.5m-mark.
- 11 Sketch your new plot on the empty graph provided.
- 12 Calculate an approximate slope for all your graphs.

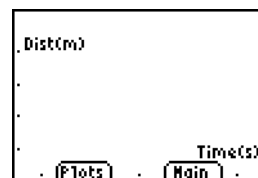

## Concepts

Function explored: linear

Distance Match introduces the real-world concepts of distance and time—or more precisely, the concept of distance *versus* time.

In Explorations, students are asked to convert their rate of walking in meters per second to kilometers per hours.

Once they have mastered the Distance-Time match, challenge your students to a Velocity-Time match.

## Materials

- ✓ calculator (see page 2 for available models)
- ✓ CBR 2™ motion detector
- ✓ unit-to-CBR 2™ or I/O unit-to-unit cable
- ✓ EasyData application

A TI ViewScreen™ panel allows other students to watch—and provides much of the fun of this activity.

## Hints

Students really enjoy this activity. Plan adequate time because everybody will want to try it!

This activity works best when the student who is walking (and the entire class) can view his or her motion projected on a wall or screen using the TI ViewScreen™ panel.

Guide the students to walk in-line with the CBR 2™ motion detector; they sometimes try to walk sideways (perpendicular to the line to the CBR 2™ motion detector) or even to jump up!

Instructions suggest that the activity be done in meters, which matches the questions on the student activity sheet.

See pages 6–9 for hints on effective data collection.

## Typical plot

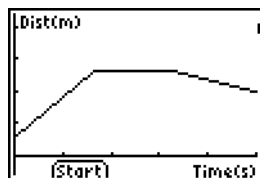

Distance vs. Time

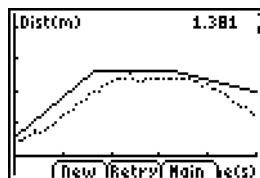

Matching Distance vs. Time

## Typical answers

1. time (from start of sample); seconds; 1 second; distance (from the CBR 2™ motion detector to the object); meters; 1 meter
2. the y-intercept represents the starting distance
3. varies by student
4. backward (increase the distance between the CBR 2™ motion detector and the object)
5. forward (decrease the distance between the CBR 2™ motion detector and the object)
6. stand still; zero slope requires no change in y (distance)
7. varies by graph;  $\Delta y/3.3$
8. varies by graph;  $\Delta y/1$
9. the segment with the greatest slope (positive or negative)
10. this is a trick question—the flat segment, because you don't move at all!
11. walking speed; when to change direction and/or speed
12. speed (or velocity)
13. varies by graph (example: 1.5 meters in 3 seconds)
14. varies by graph; example: 0.5 meters/1 second  
example:  $(0.5 \text{ meters} / 1 \text{ second}) \times (60 \text{ seconds} / 1 \text{ minute}) = 30 \text{ meters} / \text{minute}$   
example:  $(30 \text{ meters} / 1 \text{ minute}) \times (60 \text{ minutes} / 1 \text{ hour}) = 1800 \text{ meters} / \text{hour}$   
example:  $(1800 \text{ meters} / 1 \text{ hour}) \times (1 \text{ kilometer} / 1000 \text{ meters}) = 1.8 \text{ kilometers} / \text{hour}$ .
15. varies by graph; sum of the  $\Delta y$  for each line segment.



## Data collection

- 1 Hold the CBR 2™ motion detector in one hand, and the calculator in the other. Aim the sensor directly at a wall.

**Hints:** The maximum distance of any graph is 6 meters (about 20 feet) from the CBR 2™ motion detector. The minimum range is 15 centimeters (about 6 inches). Make sure that there is nothing in the *clear zone* (see page 7).

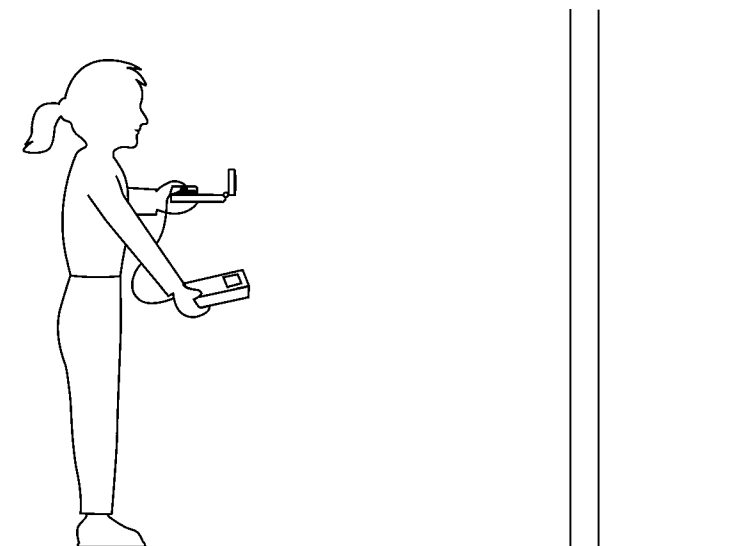

- 2 Run the EasyData App.
- 3 From the Setup menu choose 3:Distance Match.  
Distance Match automatically takes care of the settings.
- 4 Select Start (press **ZOOM**) and follow the instructions on the screen.

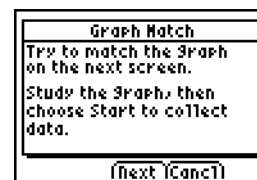

- 5 Select Next (press **ZOOM**) to display the graph to match. Take a moment to study the graph. **Answer questions 1 and 2 on the activity sheet.**

**Note:** The graph to match will be different each time step 4 and step 5 are performed.

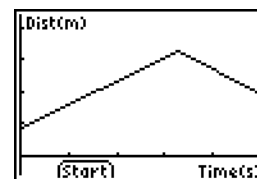

- ⑥ Position yourself where you think the graph begins. Select Start (press **WINDOW**) to begin data collection. You can hear a clicking sound and see the green light as the data is collected.
- ⑦ Walk backward and forward, and try to match the graph. Your position is plotted on the screen.
- ⑧ When the sample is finished, examine how well your “walk” matched the graph, and then *answer question 3*.
- ⑨ Select Retry (press **ZOOM**) to redisplay the same graph to match. Try to improve your walking technique, and then *answer questions 4, 5, and 6*.

### **Explorations**

In Distance Match, all graphs are comprised of three straight-line segments.

- ① Select New (press **WINDOW**) to display a new graph to match. Study the first segment and *answer questions 7 and 8*.
- ② Study the entire graph and *answer questions 9 and 10*.
- ③ Position yourself where you think the graph begins, select Start (press **WINDOW**) to begin data collection, and try to match the graph.
- ④ When the sampling stops, *answer questions 11 and 12*.
- ⑤ Select New (press **WINDOW**) to display another new graph to match.
- ⑥ Study the graph and *answer questions 13, 14, and 15*.
- ⑦ Select New (press **WINDOW**) and repeat the activity, if desired, or select Main (press **TRACE**) to return to the main screen
- ⑧ Select Quit (press **GRAPH**) and OK (press **GRAPH**) to exit the EasyData App.

## Activity 2—Match the graph

Name \_\_\_\_\_

### Data collection

1. What physical property is represented along the x-axis? \_\_\_\_\_  
What are the units? \_\_\_\_\_ How far apart are the tick marks? \_\_\_\_\_  
What physical property is represented along the y-axis? \_\_\_\_\_  
What are the units? \_\_\_\_\_ How far apart are the tick marks? \_\_\_\_\_
2. How far from the CBR 2™ motion detector do you think you should stand to begin? \_\_\_\_\_
3. Did you begin too close, too far, or just right? \_\_\_\_\_
4. Should you walk forward or backward for a segment that slopes up? \_\_\_\_\_  
Why? \_\_\_\_\_
5. Should you walk forward or backward for a segment that slopes down? \_\_\_\_\_  
Why? \_\_\_\_\_
6. What should you do for a segment that is flat? \_\_\_\_\_  
Why? \_\_\_\_\_

### Explorations

7. If you take one step every second, how long should that step be? \_\_\_\_\_
8. If, instead, you take steps of 1 meter (or 1 foot) in length, how many steps must you take? \_\_\_\_\_
9. For which segment will you have to move the fastest? \_\_\_\_\_  
Why? \_\_\_\_\_
10. For which segment will you have to move the slowest? \_\_\_\_\_  
Why? \_\_\_\_\_
11. In addition to choosing whether to move forward or backward, what other factors entered into matching the graph exactly? \_\_\_\_\_  
\_\_\_\_\_
12. What physical property does the slope, or steepness of the line segment, represent? \_\_\_\_\_
13. For the first line segment, how many meters must you walk in how many seconds? \_\_\_\_\_
14. Convert the value in question 13 (the velocity) to meters/1 second: \_\_\_\_\_  
Convert to meters/minute: \_\_\_\_\_  
Convert to meters/hour: \_\_\_\_\_  
Convert to kilometers/hour: \_\_\_\_\_
15. How far did you actually walk? \_\_\_\_\_

## Concepts

Function explored: parabolic

The motion of sliding down a playground slide is used to illustrate the real-world concept of changing velocity due to friction.

## Materials

- ✓ calculator (see page 2 for available models)
- ✓ CBR 2™ motion detector
- ✓ unit-to-CBR 2™ or I/O unit-to-unit cable
- ✓ EasyData application
- ✓ Playground slide

## Hints

The use of a playground area with several slides is preferable for this experiment. The slides should be straight. Slides with other shapes could be used in an extension. For safety reasons, remind your students not to attempt to pass each other while on the slide steps.

You may wish to carry the interfaces, calculators, and motion detectors to the playground area in a box or boxes, and distribute the equipment to your students there. Remind your students that the Motion Detector does not properly detect objects closer than 15cm.

Depending on the type of slides that are available, you may wish to change the way your students position themselves for data collection. Some slides have large platforms where the student with the Motion Detector and the student with the calculator and interface can be located.

Students can use wax paper, slippery cloth, sand, and other materials to increase their speed. To enable your students to be prepared, be sure to alert them to Part II in advance.

## Sample results

	Speed (m/sec)			
	Trial 1	Trial 2	Trial 3	Average
Part 1	1.97	2.02	2.00	2.00
Part 2	2.80	3.07	2.82	2.90

## Typical plots

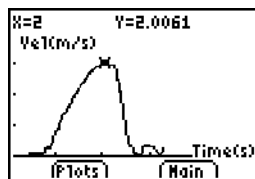

A Speedy Slide

## Typical answers

1. See the Sample Results.
2. In the Sample Results, the Part 2 speed was 0.90 m/sec greater than the Part 1 speed. Wax paper was used to decrease friction and increase speed.
3. Answers will vary. Speeds will differ because of differences such as contact area, weight, streamlining, and the use of low-friction materials.
4. Answers will vary.
5. Increasing the height of the slide should increase speed.
6. The stone dropped from the top of the slide should hit the ground first because friction and the incline of the slide slow the rolling stone more.
7. The level part at the bottom of a slide slows sliders and prevents injuries.

## Extensions

Design and carry out a plan to measure speed or velocity on a different piece of playground equipment.

Have a contest to see who in the class or group can obtain the greatest speed going down a slide.

You have been familiar with playgrounds and slides since you were a small child. The force of gravity pulls you down a slide. The force of friction slows you down. In the first part of this experiment, you will use a CBR 2™ motion detector to determine your speed or velocity going down a playground slide. In the second part, you will experiment with different ways to increase your speed going down the slide.

## Objectives

In this experiment, you will:

- use a CBR 2™ motion detector to determine your speed going down a slide
- experiment with ways to increase your speed going down the slide
- explain your results

## Data collection, Part 1, Sliding Speed

- 1 Connect the CBR 2™ motion detector to the calculator using an appropriate cable (see below) and firmly press in the cable ends.
  - If TI-83 Plus, use an I/O unit-to-unit cable
  - If TI-84 Plus, use a Standard-B to Mini-A USB cable (unit-to-CBR 2™)
- 2 On the calculator, press **[APPS]** and select EasyData to launch the EasyData App.

**Note:** EasyData will launch automatically if the CBR 2™ motion detector is connected to a TI-84 Plus using a unit-to-CBR 2™ cable.

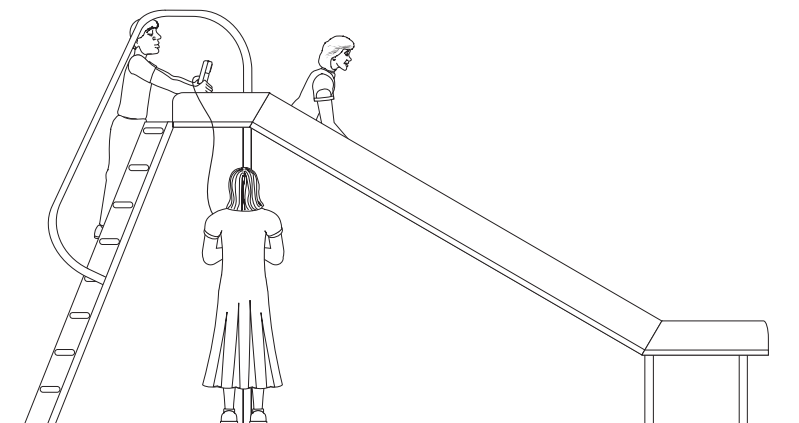

- 5 To set up the calculator for data collection:
  - a. Select Setup (press **[WINDOW]**) to open the Setup menu.
  - b. Press 2 to select 2: Time Graph to open the Time Graph Settings screen.

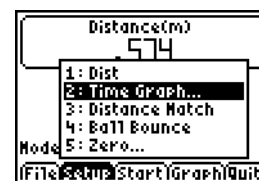

- c. Select Edit (press **ZOOM**) to open the Sample Interval dialog window.
- d. Enter 0.2 to set the time between samples in seconds.
- e. Select Next (press **ZOOM**) to advance to the Number of Samples dialog window.
- f. Enter 25 to set the number of samples. Data collection will last for 5 seconds.
- g. Select Next (press **ZOOM**) to display a summary of the new settings.
- h. Select OK (press **GRAPH**) to return to the main screen.

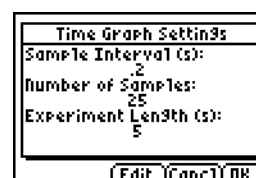
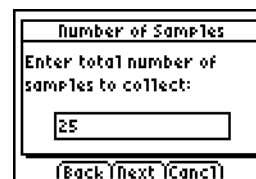
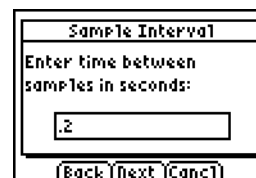

- 4 Take your preliminary data-collection positions.
  - a. One member of the group should first go up the slide steps and sit at the top of the slide.
  - b. A second person, while holding the CBR 2™ motion detector, should go high enough on the slide steps to hold the CBR 2™ motion detector behind the person who will slide.
  - c. The third person should stand on the ground next to the slide, while holding the calculator and interface.
- 5 Take your final data-collection positions.
  - a. The slider, while holding on, should move forward enough to allow a 15-cm distance between his or her back and the CBR 2™ motion detector.
  - b. The person holding the CBR 2™ motion detector should hold the CBR 2™ motion detector steady and aim it at the slider's backside.
  - c. The person holding the calculator and interface should move to a comfortable position that does not cause a pull on the CBR 2™ motion detector cable.
- 6 Collect data.
  - a. Select Start (press **ZOOM**) to begin data collection.
  - b. The slider should begin to slide as soon as a clicking is heard.
  - c. When data collection is done for this trial, the person with the CBR 2™ motion detector should come down to the ground.

**Caution:** No student should attempt to pass another person while he or she is on the steps.

7 Determine the slider's speed.

- After data collection stops and a graph of distance versus time is displayed, select Plots (press **WINDOW**).
- Press 2 to select 2: Vel vs Time to display velocity versus time.
- Use **▸** to examine data points along the graph. As you move the cursor right and left, the time (X) and velocity (Y) values of each data point are displayed above the graph. The highest point on the graph corresponds to the highest speed of the slider. Record this highest speed in the Data table. Round to the nearest 0.01 m/s. (In the example to the right, the highest speed is 2.00 m/s.)
- Select Main (press **TRACE**) to return to the main screen.

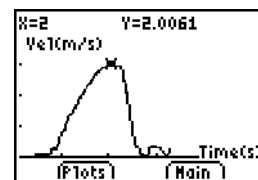

8 Repeat Steps 4–7 two more times.

## Activity 3—A Speedy slide

Name \_\_\_\_\_

### Data collection, Part 2, A Speedier Slide

1. Design a plan to increase the slider's speed.
  - a. Try out some ideas for increasing the slider's speed. You may not coat the slide with anything that must be washed off.
  - b. Decide on a plan to best increase the slider's speed.
  - c. Describe your plan in the Speedier Slide Plan section below.
2. Test your plan using Part 1, Steps 4–8.

### Speedier Slide Plan

#### Data

	Speed (m/sec)			
	Trial 1	Trial 2	Trial 3	Average
Part 1				
Part 2				

#### Data processing

1. Calculate the average speed for your three trials in Part 1. Record the average in the space provided in the Data table. Calculate and record the average speed for Part 2.
2. Subtract your Part 1 average speed from your Part 2 average speed to determine how much your team improved its speed.
3. What methods did other groups use to improve their speeds?



### ***Activity 3—A Speedy slide (cont.)***

4. Which of the methods worked best? Explain why it worked best.
  
5. If you could increase the height of the slide, how would the slider's speed be affected?
  
6. If a stone was dropped from the top of the slide at the same time a similar stone was rolled down the slide, which stone would reach the ground first? Explain.
  
7. What is the purpose of the level portion at the bottom of many slides?

## Concepts

Function explored: parabolic

Real-world concepts such as free-falling and bouncing objects, gravity, and constant acceleration are examples of parabolic functions. This activity investigates the values of height, time, and the coefficient  $A$  in the quadratic equation,  $Y = A(X - H)^2 + K$ , which describes the behavior of a bouncing ball.

## Materials

- ✓ calculator (see page 2 for available models)
- ✓ CBR 2™ motion detector
- ✓ unit-to-CBR 2™) or I/O unit-to-unit cable
- ✓ EasyData application
- ✓ large (9-inch) playground ball
- ✓ TI ViewScreen™ panel (optional)

## Hints

This activity is best performed with two students, one to hold the ball and the other to select Start on the calculator.

See pages 6–9 for hints on effective data collection.

The plot should look like a bouncing ball. If it does not, repeat the sample, ensuring that the CBR 2™ motion detector is aimed squarely at the ball. A large ball is recommended.

## Typical plot

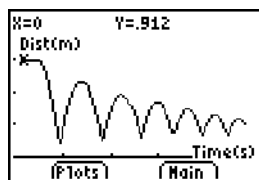

## Explorations

After an object is released, it is acted upon only by gravity (neglecting air resistance). So  $A$  depends on the acceleration due to gravity,  $-9.8$  meters/second<sup>2</sup> ( $-32$  feet/second<sup>2</sup>). The negative sign indicates that the acceleration is downward.

The value for  $A$  is approximately one-half the acceleration due to gravity, or  $-4.9$  meters/second<sup>2</sup> ( $-16$  feet/second<sup>2</sup>).

## Typical answers

1. time (from start of sample); seconds; height / distance of the ball above the floor; meters or feet
2. initial height of the ball above the floor (the peaks represent the maximum height of each bounce); the floor is represented by  $y = 0$ .

3. The Distance-Time plot for this activity does not represent the distance from the CBR 2™ motion detector to the ball. Ball Bounce flips the distance data so the plot better matches students' perceptions of the ball's behavior.  $y = 0$  on the plot is actually the point at which the ball is farthest from the CBR 2™ motion detector, when the ball hits the floor.
4. Students should realize that the x-axis represents time, not horizontal distance.
7. The graph for  $A = 1$  is both inverted and broader than the plot.
8.  $A < -1$
9. parabola concave up; concave down; linear
12. same; mathematically, the coefficient  $A$  represents the extent of curvature of the parabola; physically,  $A$  depends upon the acceleration due to gravity, which remains constant through all the bounces.

## Advanced explorations

The rebound height of the ball (maximum height for a given bounce) is approximated by:

$$y = hp^x, \text{ where}$$

- $y$  is the rebound height
- $h$  is the height from which the ball is released
- $p$  is a constant that depends on physical characteristics of the ball and the floor surface
- $x$  is the bounce number

For a given ball and initial height, the rebound height decreases exponentially for each successive bounce. When  $x = 0$ ,  $y = h$ , so the y-intercept represents the initial release height.

Ambitious students can find the coefficients in this equation using the collected data. Repeat the activity for different initial heights or with a different ball or floor surface.

After manually fitting the curve, students can use regression analysis to find the function that best models the data. Follow the calculator operating procedures to perform a quadratic regression on lists L1 and L2.

## Extensions

Integrate under Velocity-Time plot, giving the displacement (net distance traveled) for any chosen time interval. Note the displacement is zero for any full bounce (ball starts and finishes on floor).

## Data collection

- 1 Begin with a test bounce. Drop the ball (do not throw it).

**Hints:** Position the CBR 2™ motion detector at least 0.5 meters (about 1.5 feet) above the height of the highest bounce. Hold the sensor directly over the ball and make sure that there is nothing in the *clear zone* (see page 7).

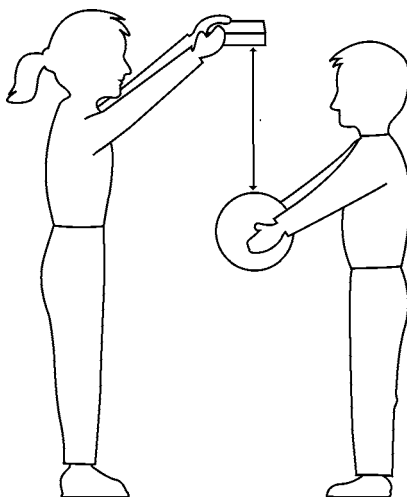

- 2 Run the EasyData App.
- 3 From the Setup menu, choose 4:Ball Bounce, and then select Start (press **ZOOM**).  
General instructions are displayed. Ball Bounce automatically takes care of the settings.
- 4 Have one person hold the calculator and CBR 2™ motion detector, while another person holds the ball beneath the sensor.
- 5 Select Start (press **ZOOM**). When the CBR 2™ motion detector begins clicking, release the ball, and then step back. (If the ball bounces to the side, move to keep the CBR 2™ motion detector directly above the ball, but be careful **not** to change the height of the CBR 2™ motion detector.)
- 6 When the clicking stops, the collected data is transferred to the calculator and a plot of distance vs. time is displayed.
- 7 If the plot doesn't look good, select Main, Start, Start to repeat the sample. Study the plot. **Answer questions 1 and 2 on the activity sheet.**
- 8 Observe that Ball Bounce automatically flipped the distance data. **Answer questions 3 and 4.**

## Explorations

The Distance-Time plot of the bounce forms a parabola.

- ❶ The plot is in Trace mode. Press  $\square$  to determine the vertex of the first good bounce—a nice shape without lots of extra noise. **Answer question 5** on the activity sheet.
- ❷ Select Main to return to the main screen. Choose Quit, and then select OK to quit EasyData.
- ❸ The *vertex form* of the quadratic equation,  $Y = A(X - H)^2 + K$ , is appropriate for this analysis. Press  $\boxed{Y=}$ . In the Y= editor, turn off any functions that are selected. Enter the vertex form of the quadratic equation:  $Yn=A*(X-H)^2+K$ .

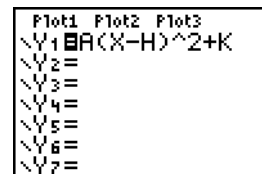

**Note:** If you have the Transformation Graphing App installed on your calculator, this is accomplished much easier by changing coefficient values directly on the graph screen.

- ❹ On the Home screen, store the value you recorded in question 5 for the height in variable  $K$ ; store the corresponding time in variable  $H$ ; store 1 in variable  $A$ .

For example: Press 4  $\boxed{\text{STO}} \boxed{\text{ALPHA}} K \boxed{\text{ENTER}}$ , 2.5  $\boxed{\text{STO}} \boxed{\text{ALPHA}} H \boxed{\text{ENTER}}$ , 1  $\boxed{\text{STO}} \boxed{\text{ALPHA}} A \boxed{\text{ENTER}}$  to set  $K=4$ ,  $H=2.5$ , and  $A=1$ .

- ❺ Press  $\boxed{\text{GRAPH}}$  to display the graph. **Answer questions 6 and 7.**
- ❻ Try  $A = 2, 0, -1$ . **Complete the first part of the chart in question 8 and answer question 9.**
- ❼ Choose values of your own for  $A$  until you have a good match for the plot. **Record your choices for  $A$  in the chart in question 8.**
- ❽ Repeat the activity, but this time choose the last (right-most) full bounce. **Answer questions 10, 11, and 12.**

## Advanced explorations

- ❶ Repeat the data collection, but do not choose a single parabola.
- ❷ Record the time and height for each successive bounce.
- ❸ Determine the ratio between the heights for each successive bounce.
- ❹ Explain the significance, if any, of this ratio.

# Activity 4—Bouncing ball

Name \_\_\_\_\_

## Data collection

1. What physical property is represented along the x-axis? \_\_\_\_\_  
What are the units? \_\_\_\_\_  
What physical property is represented along the y-axis? \_\_\_\_\_  
What are the units? \_\_\_\_\_
2. What does the highest point on the plot represent? \_\_\_\_\_  
The lowest point? \_\_\_\_\_
3. Why did the Ball Bounce App flip the plot? \_\_\_\_\_
4. Why does the plot look like the ball bounced across the floor? \_\_\_\_\_

## Explorations

5. Record the maximum height and corresponding time for the first full bounce. \_\_\_\_\_
6. Did the graph for  $A = 1$  match your plot of the data from the first complete bounce? \_\_\_\_\_
7. Why or why not? \_\_\_\_\_
8. Complete the chart below.

A	How do the data plot and the $Y_n$ graph compare?
1	
2	
0	
-1	

9. What does a positive value for  $A$  imply? \_\_\_\_\_  
What does a negative value for  $A$  imply? \_\_\_\_\_  
What does a zero value for  $A$  imply? \_\_\_\_\_
10. Record the maximum height and corresponding time for the last full bounce. \_\_\_\_\_
11. Do you think  $A$  will be bigger or smaller for the last bounce? \_\_\_\_\_
12. How did  $A$  compare? \_\_\_\_\_  
What do you think  $A$  might represent? \_\_\_\_\_

## Concepts

Function explored: parabolic

Plotting a ball rolling down a ramp of varying inclines creates a family of curves, which can be modeled by a series of quadratic equations. This activity investigates the values of the coefficients in the quadratic equation,  $y = ax^2 + bx + c$ .

## Materials

- ✓ calculator (see page 2 for available models)
- ✓ CBR 2™ motion detector
- ✓ unit-to-CBR 2™) or I/O unit-to-unit cable
- ✓ EasyData application
- ✓ large (9 inch) playground ball
- ✓ long ramp (at least 2 meters or 6 feet—a lightweight board works well)
- ✓ protractor to measure angles
- ✓ books to prop up ramp
- ✓ TI ViewScreen™ panel (optional)

## Hints

Discuss how to measure the angle of the ramp. Let students get creative here in measuring the initial angle. For example, they might use a trigonometric calculation or folded paper.

For steeper angles (greater than 60°), you may want to use a CBR 2™ motion detector clamp (sold separately).

See pages 6–9 for hints on effective data collection.

## Typical plots

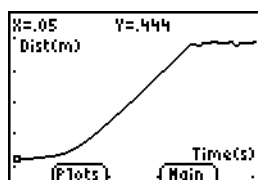
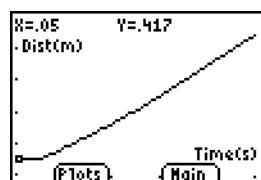

## Typical answers

1. the third plot
2. time; seconds; distance of object from CBR 2™ motion detector; feet or meters

3. varies (should be half of a parabola, concave up)
4. a parabola (quadratic)
5. varies
6. varies (should be parabolic with increasing curvature)
7. 0° is flat (ball can't roll); 90° is the same as a free-falling (dropping) ball

## Explorations

The motion of a body acted upon only by gravity is a popular topic in a study of physical sciences. Such motion is typically expressed by a particular form of the quadratic equation,

$$s = \frac{1}{2}at^2 + v_i t + s_i \text{ where}$$

- $s$  is the position of an object at time  $t$
- $a$  is its acceleration
- $v_i$  is its initial velocity
- $s_i$  is its initial position

In the quadratic equation  $y = ax^2 + bx + c$ ,  $y$  represents the distance from the CBR 2™ motion detector to the ball at time  $x$  if the ball's initial position was  $c$ , initial velocity was  $b$ , and acceleration is  $2a$ .

## Advanced explorations:

Since the ball is at rest when released,  $b$  should approach zero for each trial.  $c$  should approach the initial distance, 0.5 meters (1.5 feet).  $a$  increases as the angle of inclination increases.

If students model the equation  $y = ax^2 + bx + c$  manually, you may need to provide hints for the values of  $b$  and  $c$ . You may also direct them to perform a quadratic regression on lists L1, L2 using their calculators. The ball's acceleration is due to the earth's gravity. So the more the ramp points down (the greater the angle of inclination), the greater the value of  $a$ . Maximum  $a$  occurs for  $\theta = 90^\circ$ , minimum for  $\theta = 0^\circ$ . In fact,  $a$  is proportional to the sine of  $\theta$ .

## Data collection

- 1 Answer question 1 on the activity sheet. Use the protractor to set the ramp at a  $15^\circ$  incline. Lay the CBR 2™ motion detector on the ramp and flip the sensor head so it is perpendicular to the ramp.

Mark a spot on the ramp 15 centimeters (about six inches) from the CBR 2™ motion detector. Have one student hold the ball at this mark, while a second student holds the calculator and CBR 2™ motion detector.

**Hints:** Aim the sensor directly at the ball and make sure that there is nothing in the clear zone (see page 7).

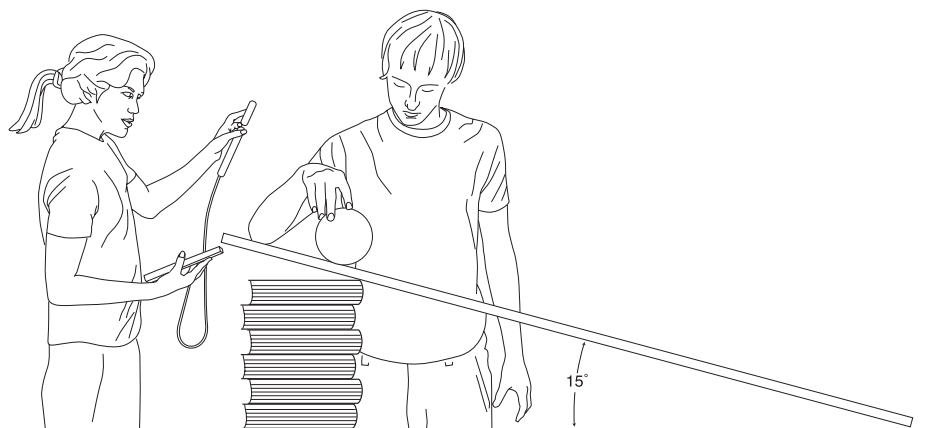

- 2 Run the EasyData App.
- 3 To set up the calculator for data collection:
  - a. Select Setup (press **WINDOW**) to open the Setup menu.
  - b. Press 2 to select 2: Time Graph to open the Time Graph Settings screen.
  - c. Select Edit (press **ZOOM**) to open the Sample Interval dialog window.
  - d. Enter 0.1 to set the time between samples in seconds.
  - e. Select Next (press **ZOOM**) to advance to the Number of Samples dialog window.
  - f. Enter 30 to set the number of samples. Data collection will last for 3 seconds.

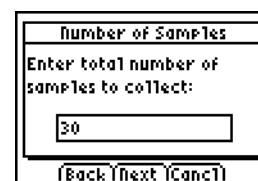
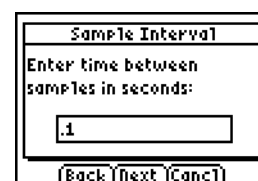
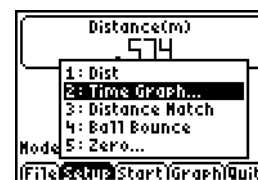

- g. Select Next (press **ZOOM**) to display a summary of the new settings.
- h. Select OK (press **GRAPH**) to return to the main screen.

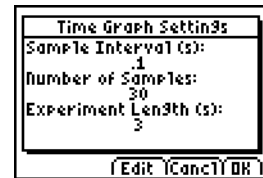

- ④ When the settings are correct, choose Start (press **ZOOM**) to begin sampling.
- ⑤ When the clicking begins, release the ball immediately (don't push) and step back.
- ⑥ When the clicking stops, the collected data is transferred to the calculator and a plot of distance vs. time is displayed. **Answer questions 2, 3, 4, and 5.**

**Explorations**

Examine what happens for differing inclines.

- ① Predict what will happen if the incline increases. **Answer question 6.**
- ② Adjust the incline to  $30^\circ$ . Repeat steps 2 through 6. **Add this plot to the drawing in question 6, labeled  $30^\circ$ .**
- ③ Repeat steps 2 through 6 for inclines of  $45^\circ$  and  $60^\circ$  and add to the drawing.
- ④ **Answer question 7.**

**Advanced explorations**

Adjust the time values so that  $x = 0$  for the initial height (the time at which the ball was released). You can do this manually by subtracting the  $x$  value for the first point from all the points on your plot, or you can enter  $L1(1) \rightarrow A: L1 - A \rightarrow L1$ .

- ① Calculate the values for  $a$ ,  $b$ , and  $c$  for the family of curves in the form  $y = ax^2 + bx + c$  at  $0^\circ$ ,  $15^\circ$ ,  $30^\circ$ ,  $45^\circ$ ,  $60^\circ$ ,  $90^\circ$ .
- ② What are the minimum and maximum values for  $a$ ? Why?
- ③ Write an expression describing the mathematical relationship between  $a$  and the angle of inclination.



# Activity 5—Rolling ball

Name \_\_\_\_\_

## Data collection

1. Which of these plots do you think best matches the *Distance-Time* plot of a ball rolling down a ramp?

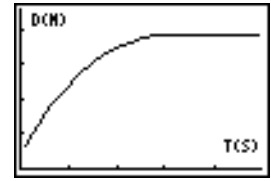
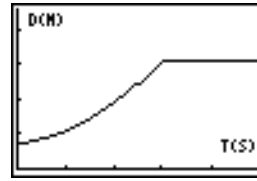
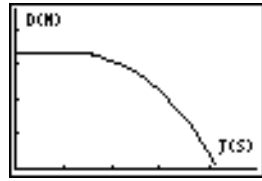
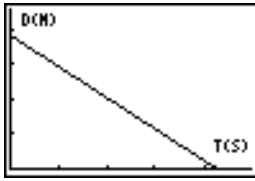

2. What physical property is represented along the x-axis? \_\_\_\_\_

What are the units? \_\_\_\_\_

What physical property is represented along the y-axis? \_\_\_\_\_

What are the units? \_\_\_\_\_

3. Sketch what the plot really looks like. Label the axis. Label the plot at the points when the ball was released and when it reached the end of the ramp.



4. What type of function does this plot, between the two points you identified, represent? \_\_\_\_\_

5. Discuss your change in understanding between the graph you chose in question 1 and the curve you sketched in question 3. \_\_\_\_\_

## Explorations

6. Sketch what you think the plot will look like with a greater incline. (Label it *prediction*.)



7. Sketch and label the plots for  $0^\circ$  and  $90^\circ$ :

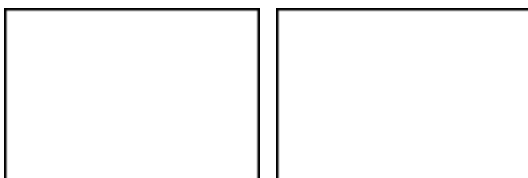

## Teacher information

### ***How might your classes change with a CBR 2™ sonic motion detector?***

The CBR 2™ motion detector is an easy-to-use system with features that help you integrate it into your lesson plans quickly and easily.

The CBR 2™ motion detector offers significant improvements over other data-collection methods you may have used in the past. This, in turn, may lead to a restructuring of how you use class time, as your students become more enthusiastic about using real-world data.

- You'll find that your students feel a greater sense of ownership of the data because they actually participate in the data-collection process rather than using data from textbooks, periodicals, or statistical abstracts. This impresses upon them that the concepts you explore in class are connected to the real world and aren't just abstract ideas. But it also means that each student will want to take his or her turn at collecting the data.
- Data collection with CBR 2™ motion detector is considerably more effective than creating scenarios and manually taking measurements with a ruler and stopwatch. Since more sampling points give greater resolution and since a sonic motion detector is highly accurate, the shape of curves is more readily apparent. You will need less time for data collection and have more time for analysis and exploration.
- With CBR 2™ motion detector students can explore the repeatability of observations and variations in what-if scenarios. Such questions as "Is it the same parabola if we drop the ball from a greater height?" and "Is the parabola the same for the first bounce as the last bounce?" become natural and valuable extensions.
- The power of visualization lets students quickly associate the plotted list data with the physical properties and mathematical functions the data describes.

Other changes occur once the data from real-world events is collected. CBR 2™ motion detector lets your students explore underlying relationships both numerically and graphically.

#### **Explore data graphically**

Use automatically generated plots of distance, velocity, and acceleration with respect to time for explorations such as:

- What is the physical significance of the y-intercept? the x-intercept? the slope? the maximum? the minimum? the derivatives? the integrals?
- How do we recognize the function (linear, parabolic, etc.) represented by the plot?
- How would we model the data with a representative function? What is the significance of the various coefficients in the function (e.g.,  $AX^2 + BX + C$ )?

#### **Explore data numerically**

Your students can employ statistical methods (mean, median, mode, standard deviation, etc.) appropriate for their level to explore the numeric data. When you exit the EasyData App, a prompt reminds you of the lists in which time (L1), distance (L2), velocity (L3), and acceleration (L4) are stored.

## Teacher information (cont.)

### CBR 2™ motion detector plots—connecting the physical world and mathematics

The plots created from the data collected by EasyData are a visual representation of the relationships between the physical and mathematical descriptions of motion. Students should be encouraged to recognize, analyze, and discuss the shape of the plot in both physical and mathematical terms. Additional dialog and discoveries are possible when functions are entered in the Y= editor and displayed with the data plots.

Performing the same calculations as CBR 2™ motion detector is an interesting classroom activity.

1. Collect sample data. Exit the EasyData App.
2. Use the sample times in L1 in conjunction with the distance data in L2 to calculate the velocity of the object at each sample time. Then compare the results to the velocity data in L3.

$$L3_n = \frac{(L2_{n+1} + L2_n)/2 - (L2_n + L2_{n-1})/2}{L1_{n+1} - L1_n}$$

3. Use the velocity data in L3 (or the student-calculated values) in conjunction with the sample times in L1 to calculate the acceleration of the object at each sample time. Then compare the results to the acceleration data in L4.
- A *Distance-Time plot* represents the approximate position of an object (distance from the CBR 2™ motion detector) at each instant in time when a sample is collected. y-axis units are meters or feet; x-axis units are seconds.
  - A *Velocity-Time plot* represents the approximate speed of an object (relative to, and in the direction of, the CBR 2™ motion detector) at each sample time. y-axis units are meters/second or feet/second; x-axis units are seconds.
  - An *Acceleration-Time plot* represents the approximate rate of change in speed of an object (relative to, and in the direction of, the CBR 2™ motion detector) at each sample time. y-axis units are meters/second<sup>2</sup> or feet/second<sup>2</sup>; x-axis units are seconds.
  - The *first derivative* (instantaneous slope) at any point on the Distance-Time plot is the speed at that instant.
  - The *first derivative* (instantaneous slope) at any point on the Velocity-Time plot is the acceleration at that instant. This is also the second derivative at any point on the Distance-Time plot.
  - A *definite integral* (area between the plot and the x-axis between any two points) on the Velocity-Time plot equals the displacement (net distance traveled) by the object during that time interval.
  - *Speed* and *velocity* are often used interchangeably. They are different, though related, properties. Speed is a *scalar* quantity; it has magnitude but no specified direction, as in "6 feet per second." Velocity is a *vector* quantity; it has a specified direction as well as magnitude, as in "6 feet per second due North."

## Teacher information (cont.)

A typical CBR 2™ motion detector Velocity-Time plot actually represents speed, not velocity. Only the magnitude (which can be positive, negative, or zero) is given. Direction is only implied. A positive velocity value indicates movement away from the CBR 2™ motion detector; a negative value indicates movement toward the CBR 2™ motion detector.

The CBR 2™ motion detector measures distance only along a line from the detector. Thus, if an object is moving at an angle to the line, it only computes the component of velocity parallel to this line. For example, an object moving perpendicular to the line from the CBR 2™ motion detector shows zero velocity.

### The mathematics of distance, velocity, and acceleration

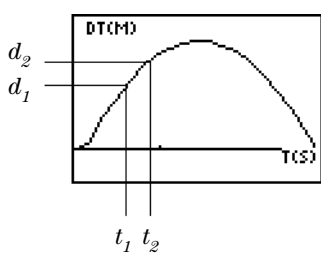

Distance-Time plot

$$V_{\text{average}} = \frac{\Delta d}{\Delta t} = \frac{d_2 - d_1}{t_2 - t_1} = \text{slope of Distance-Time plot}$$

$$V_{\text{instantaneous}} = \lim_{\Delta t \rightarrow 0} \left( \frac{\Delta d}{\Delta t} \right) = \frac{d(s)}{dt} \quad \text{where } s = \text{distance}$$

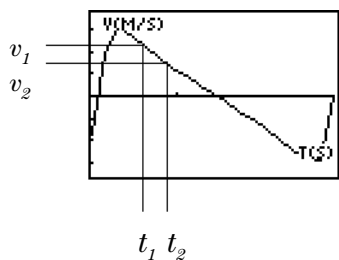

Velocity-Time plot

$$A_{\text{average}} = \frac{\Delta v}{\Delta t} = \frac{v_2 - v_1}{t_2 - t_1} = \text{slope of Velocity-Time plot}$$

$$A_{\text{instantaneous}} = \lim_{\Delta t \rightarrow 0} \left( \frac{\Delta v}{\Delta t} \right) = \frac{dv}{dt}$$

## Teacher information (cont.)

The area under the Velocity-Time plot from  $t_1$  to  $t_2 = \Delta d = (d_2 - d_1)$  = displacement from  $t_1$  to  $t_2$  (net distance traveled).

$$\text{So, } \Delta d = \left( \sum_{t=1}^{t=2} v(\Delta t) \right) \quad \text{or} \quad \Delta d = \int_{t=1}^{t=2} v(dt)$$

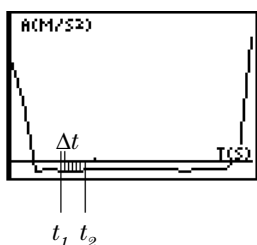

Acceleration-Time plot

### Web-site resources

At TI's Web Site, [education.ti.com](http://education.ti.com), you will find:

- a listing of supplemental material for use with the CBR 2™ motion detector and TI graphing calculators
- an activities page with applications developed and shared by teachers like you
- CBR 2™ motion detector programs that access additional CBR 2™ motion detector features
- more detailed information about the CBR 2™ motion detector settings and programming commands

### Additional resources

Texas Instruments' *Explorations* books provide supplemental material related to TI graphing calculators, including books with classroom activities for the CBR 2™ motion detector appropriate for middle-school and high-school math and science classes.

## ***Sonic motion detector data is stored in lists***

### ***Collected data is stored lists L1, L2, L3, and L4***

When the CBR 2™ motion detector collects data, it automatically transfers it to the calculator and stores the data in lists. Each time you exit the EasyData App, you are reminded of where the data is stored.

- L1 contains time data.
- L2 contains distance data.
- L3 contains velocity data.
- L4 contains acceleration data.

For example, the 5th element in list L1 represents the time when the 5th data point was collected, and the 5th element in list L2 represents the distance of the 5th data point.

### ***Using the data lists***

The lists are not deleted when you exit the EasyData App. Thus, they are available for additional graphical, statistical, and numerical explorations and analyses.

You can plot the lists against each other, display them in the list editor, use regression analysis, and perform other analytical activities. For example, you could collect data from a student walking away from the CBR 2™ motion detector. Then using the TI-84 Plus calculator manual-fit linear regression, you could have students find a line of best fit.

# EasyData settings

## Changing EasyData settings

EasyData displays the most commonly used settings before data collection begins.

- ❶ From the main screen in the EasyData App, choose Setup > 1: Dist or 2: Time Graph. The current settings are displayed on the calculator.  
**Note:** Settings for 3: Distance Match and 4: Ball Bounce in the Setup menu are preset and cannot be changed.
- ❷ Select Next (press **ZOOM**) to move to the setting you want to change. Press **CLEAR** to clear a setting.
- ❸ Repeat to cycle through the available options. When the option is correct, select Next to move to the next option.
- ❹ To change a setting, enter 1 or 2 digits, and then select Next.
- ❺ When all the settings are correct, select OK (press **GRAPH**) to return to the main screen.

The new settings remain in effect unless you choose to set EasyData to its default settings, run an application, or run another activity that changes the settings. If you manipulate L5 outside the EasyData App or delete L5, the default settings may be restored the next time you run EasyData.

## Restoring EasyData settings to the defaults

The default settings are appropriate for a wide variety of sampling situations. If you are unsure of the best settings, begin with the default settings, and then adjust the settings for your specific activity.

- To restore the default settings in EasyData while the CBR 2™ motion detector is connected to the calculator, choose File > 1:New.
- To change settings, follow the steps previously described above.
- Select Start (press **ZOOM**) to begin collecting data.

# Using a CBR 2™ Sonic Motion Detector with a CBL 2™ System or with CBL 2™ System programs

## Using a CBR 2™ sonic motion detector as a conventional motion detector with a CBL 2™ System

The CBR™ motion detector can be used as a conventional motion detector with the Texas Instruments CBL 2™ (Calculator-Based Laboratory™) system.

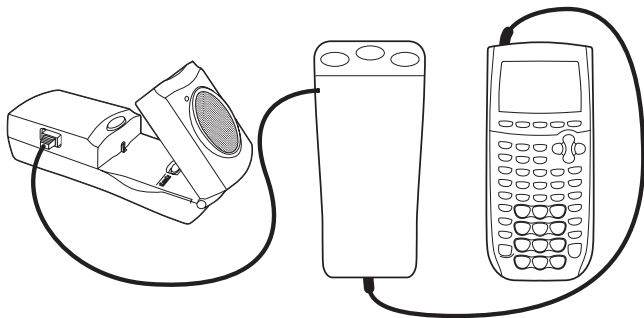

A special cable is required to connect the CBR 2™ motion detector to a CBL 2™ system.

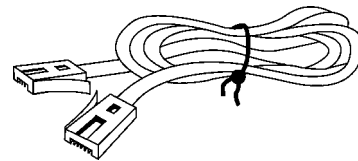

You may order the cable by calling 1-800-TI-CARES.

Do not connect a CBR 2™ motion detector to a CBL 2™ system at the same time that the CBR 2™ motion detector is connected to a calculator. The calculator must be connected to the CBL 2™ system.

You may need to change the CBL 2™ system program as noted below. The EasyData App does not function with a CBL 2™ system.

## Collecting Motion Data Using the CBR 2™ sonic motion detector with a CBL 2™ System

- 1 Insert batteries into the CBL 2™.
- 2 Connect the CBL 2™ motion detector to a TI graphing calculator using the I/O unit-to-unit link cable.
- 3 Plug your CBR 2™ motion detector into the DIG/SONIC port of the CBL 2™ system using a CBL-to-CBR cable (sold separately).
- 4 Run DataMate from the Apps menu on the TI-83 Plus or TI-84 Plus family of products.
- 5 DataMate automatically identifies the CBL 2™ sensors, loads its calibration factors, and displays the name of the sensor (Motion in this case), as well as the current distance reading in meters. It also loads a default motion experiment of 5 seconds.





# Using a CBR 2™ Sonic Motion Detector with a CBL 2™ System or with CBL 2™ System programs (cont.)

- Start collecting data with the default experiment.

Hold the motion sensor in your hand and choose 2: START to begin data collection.

- Walk towards a wall while holding the CBR 2™ motion detector pointed towards the wall.

When finished, your graph will be similar to the one shown here.

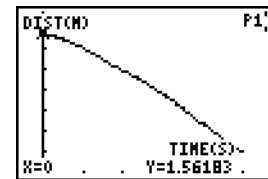
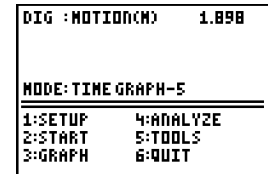

# Batteries

## Battery type

CBR 2™ motion detector is designed to operate with 4 AA alkaline batteries. CBR 2™ motion detector can run without batteries only if attached to a CBL 2™.

## Battery installation

Exit the EasyData App before changing batteries.

1. Holding the CBR 2™ motion detector upside down, use your thumb to slide the battery compartment cover toward the back of the CBR 2™ motion detector.
2. Position batteries according to the diagram on the inside of the CBR 2™ motion detector battery compartment.
3. Two batteries fit positive side up in the side marked +. Two batteries fit negative side up in the side marked -.
4. Slide the cover back on. CBR 2™ motion detector is ready to begin sampling.

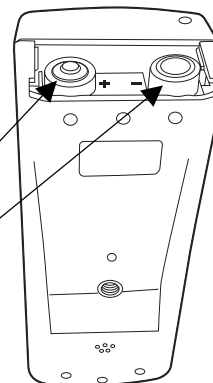

## CBR 2™ sonic motion detector low battery warnings

The CBR 2™ motion detector has two mechanisms to alert you that the batteries are low:

- The EasyData App displays a warning message on calculator screen while trying to collect data.
- The red light flashes intermittently while the CBR 2™ motion detector is collecting sample data.

## Battery precautions

- DO NOT use rechargeable batteries.
- Replace all four batteries at the same time. Do not mix brands of batteries. Do not mix types within a battery brand.
- Install batteries according to the diagrams inside the battery compartment.
- Properly dispose of used batteries immediately. Do not leave them within the reach of children.
- Do not heat, burn, or puncture batteries. Batteries contain hazardous chemicals and may explode or leak.
- Do not mix rechargeable and nonrechargeable batteries.
- Do not place nonrechargeable batteries in a battery recharger.

## In case of difficulty

<b><i>If you have this problem:</i></b>	<b><i>Try this:</i></b>
Difficulty collecting data	<p>Check for a poor calculator-to-CBR 2™ motion detector connection. Always push in <b>firmly</b> on both ends of the cable.</p> <p>Check for low batteries (see page 40).</p>
The CBR 2™ motion detector begins collecting data by itself	<p>If you set down the CBR 2™ motion detector with the <b>TRIGGER</b> button face down, the <b>TRIGGER</b> button may depress and activate sampling. Press <b>TRIGGER</b> again to stop sampling.</p> <p>Before storing the CBR 2™ motion detector, properly exit the EasyData App (using Quit) or any other CBR 2™ motion detector or CBL 2™ system App.</p>
The CBR 2™ motion detector doesn't quit collecting data	<p>Press <b>TRIGGER</b> to stop sampling. Repeat sample. If problem continues, remove one battery and put it back in. Note: Any data stored in the CBR 2™ motion detector will be lost.</p>
Communication Error	<p>Attach the CBR 2™ motion detector to the calculator with the Standard-B to Mini-A USB cable (unit-to-CBR 2™).</p> <p>Check for a poor calculator-to-CBR 2™ motion detector connection. Always push in <b>firmly</b> on both ends of the cable.</p> <p>If you do not want to (or cannot) attach the CBR 2™ motion detector to the calculator, quit the EasyData App.</p>
Insufficient memory	<p>You must have sufficient memory for the EasyData App and the data lists. EasyData needs 5000 bytes to run effectively. You need to delete items from the calculator memory.</p> <p>On the TI calculator, press <b>2nd</b> [MEM] 2:Mem Mgmt./Del. Choose items to delete and press DEL to delete the selected items.</p>
Calculator doesn't match activity instructions	<p>This guide applies to all the TI calculators that can load the EasyData App. You may find that some of the menu names, screens, or keys in this guide do not match exactly those on your calculator. If using Ranger, or other programs, choose the closest match. For example, if the instructions say "Choose DISTANCE MATCH," on the TI-83 you would choose DIST MATCH.</p>
Data doesn't look right: <ul style="list-style-type: none"> <li>■ points not on the curve</li> <li>■ jagged plots</li> <li>■ flat plots</li> <li>■ broken plot</li> </ul>	<p>Repeat the sample, ensuring that the CBR 2™ motion detector is aimed directly at the object.</p> <p>Read pages 6–9 on getting good data samples.</p> <p>Check that the <i>clear zone</i> does not contain students, tables, or other objects.</p> <p>Check the position of the Sensitivity switch.</p> <p>When using two CBR 2™ units at the same time in the same room, one group should complete a sample before the next group begins their sample.</p> <p>Check for a poor calculator-to-CBR 2™ motion detector connection. Always push in <b>firmly</b> on both ends of the cable.</p> <p>Check for low batteries (see page 40).</p>
Lost unit-to-CBR 2™ cable	<p>You can use the I/O unit-to-unit cable that came with the calculator. (The unit-to-CBR 2™ cable allows auto-launching of EasyData and a more reliable connection, so you may wish to order a replacement cable.)</p>
Frequently low batteries	<p>Before storing the CBR 2™ motion detector, properly exit the EasyData App (using Quit) or any other CBR 2™ motion detector or CBL 2™ program, and disconnect the CBR 2™ motion detector from the calculator.</p>

# EasyData menu map

Each screen displays one or more options along the bottom of the screen. To select an option, press the graphing key directly below the option.

To navigate the menus as indicated below, select the menu options indicated by .

 indicates data is being collected.

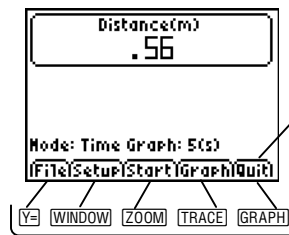

For example, press [GRAPH] to select Quit.

## Main Menu

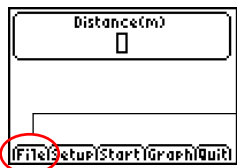

## File Menu



## Setup Menu



## Quit Menu

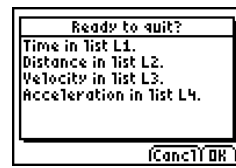

## 1: Dist

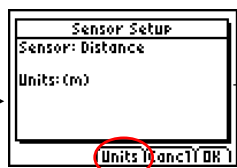

## Units

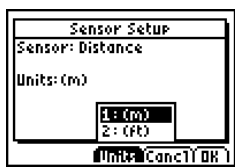

## 2: Time Graph

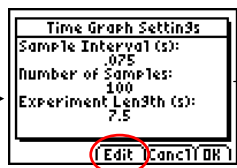

## Set sample interval

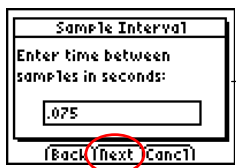

## Set # of samples

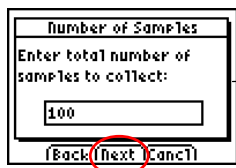

## Time Graph Mode

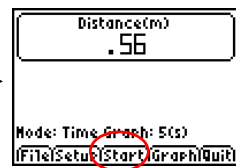

## Sample plot

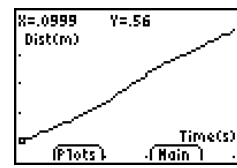

## 3: Distance Match



## Instructions



## Graph to Match

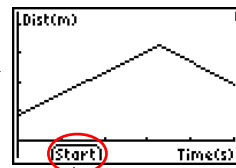

## Sample Match

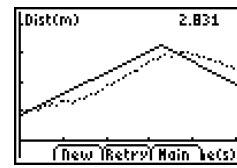

## 4: Ball Bounce



## Instructions

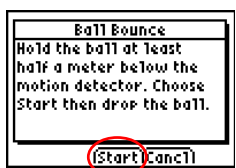

## Sample Plot

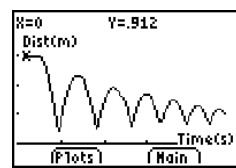

# *TI service and warranty*

## **For US Customers Only**

### **For general information**

Home Page:	education.ti.com
KnowledgeBase and E-mail Inquiries:	education.ti.com/support
Phone:	(800) TI-CARES; (800) 842- 2737 For U.S., Canada, Mexico, Puerto Rico, and Virgin Islands only
International Information:	education.ti.com/international

### **For technical support**

KnowledgeBase and Support by E-mail:	education.ti.com/support
Phone (not toll-free):	(972) 917-8324

### **For product (hardware) service**

**Customers in the U.S., Canada, Mexico, Puerto Rico and Virgin Islands:** Always contact TI Customer Support before returning a product for service.

**All other customers:** Refer to the leaflet enclosed with this product (hardware) or contact your local TI retailer/distributor.

## ***Texas Instruments (TI) Warranty Information***

### **Customers in the U.S. and Canada Only**

#### **One-Year Limited Warranty for Commercial Electronic Product**

This Texas Instruments ("TI") electronic product warranty extends only to the original purchaser and user of the product.

**Warranty Duration.** This TI electronic product is warranted to the original purchaser for a period of one (1) year from the original purchase date.

**Warranty Coverage.** This TI electronic product is warranted against defective materials and construction. **THIS WARRANTY IS VOID IF THE PRODUCT HAS BEEN DAMAGED BY ACCIDENT OR UNREASONABLE USE, NEGLIGENCE, IMPROPER SERVICE, OR OTHER CAUSES NOT ARISING OUT OF DEFECTS IN MATERIALS OR CONSTRUCTION.**

**Warranty Disclaimers.** ANY IMPLIED WARRANTIES ARISING OUT OF THIS SALE, INCLUDING BUT NOT LIMITED TO THE IMPLIED WARRANTIES OF MERCHANTABILITY AND FITNESS FOR A PARTICULAR PURPOSE, ARE LIMITED IN DURATION TO THE ABOVE ONE-YEAR PERIOD. TEXAS INSTRUMENTS SHALL NOT BE LIABLE FOR LOSS OF USE OF THE PRODUCT OR OTHER INCIDENTAL OR CONSEQUENTIAL COSTS, EXPENSES, OR DAMAGES INCURRED BY THE CONSUMER OR ANY OTHER USER.

Some states/provinces do not allow the exclusion or limitation of implied warranties or consequential damages, so the above limitations or exclusions may not apply to you.

**Legal Remedies.** This warranty gives you specific legal rights, and you may also have other rights that vary from state to state or province to province.

**Warranty Performance.** During the above one (1) year warranty period, your defective product will be either repaired or replaced with a reconditioned model of an equivalent quality (at TI's option) when the product is returned, postage prepaid, to Texas Instruments Service Facility. The warranty of the repaired or replacement unit will continue for the warranty of the original unit or six (6) months, whichever is longer. Other than the postage requirement, no charge will be made for such repair and/or replacement. TI strongly recommends that you insure the product for value prior to mailing.

**Software.** Software is licensed, not sold. TI and its licensors do not warrant that the software will be free from errors or meet your specific requirements. **All software is provided "AS IS."**

**Copyright.** The software and any documentation supplied with this product are protected by copyright.

## **Australia & New Zealand Customers only**

### **One-Year Limited Warranty for Commercial Electronic Product**

This Texas Instruments electronic product warranty extends only to the original purchaser and user of the product.

**Warranty Duration.** This Texas Instruments electronic product is warranted to the original purchaser for a period of one (1) year from the original purchase date.

**Warranty Coverage.** This Texas Instruments electronic product is warranted against defective materials and construction. This warranty is void if the product has been damaged by accident or unreasonable use, neglect, improper service, or other causes not arising out of defects in materials or construction.

**Warranty Disclaimers.** Any implied warranties arising out of this sale, including but not limited to the implied warranties of merchantability and fitness for a particular purpose, are limited in duration to the above one-year period. Texas Instruments shall not be liable for loss of use of the product or other incidental or consequential costs, expenses, or damages incurred by the consumer or any other user.

Except as expressly provided in the One-Year Limited Warranty for this product, Texas Instruments does not promise that facilities for the repair of this product or parts for the repair of this product will be available.

Some jurisdictions do not allow the exclusion or limitation of implied warranties or consequential damages, so the above limitations or exclusions may not apply to you.

**Legal Remedies.** This warranty gives you specific legal rights, and you may also have other rights that vary from jurisdiction to jurisdiction.

**Warranty Performance.** During the above one (1) year warranty period, your defective product will be either repaired or replaced with a new or reconditioned model of an equivalent quality (at TI's option) when the product is returned to the original point of purchase. The repaired or replacement unit will continue for the warranty of the original unit or six (6) months, whichever is longer. Other than your cost to return the product, no charge will be made for such repair and/or replacement. TI strongly recommends that you insure the product for value if you mail it.

**Software.** Software is licensed, not sold. TI and its licensors do not warrant that the software will be free from errors or meet your specific requirements. All software is provided "AS IS."

**Copyright.** The software and any documentation supplied with this product are protected by copyright.

## **All Other Customers**

For information about the length and terms of the warranty, refer to your package and/or to the warranty statement enclosed with this product, or contact your local Texas Instruments retailer/distributor.

## ***FCC information concerning radio frequency interference***

This equipment has been tested and found to comply with the limits for a Class B digital device, pursuant to Part 15 of the FCC rules. These limits are designed to provide reasonable protection against harmful interference in a residential installation. This equipment generates, uses, and can radiate radio frequency energy and, if not installed and used in accordance with the instructions, may cause harmful interference with radio communications. However, there is no guarantee that interference will not occur in a particular installation.

If this equipment does cause harmful interference to radio or television reception, which can be determined by turning the equipment off and on, you can try to correct the interference by one or more of the following measures:

- Reorient or relocate the receiving antenna.
- Increase the separation between the equipment and receiver.
- Connect the equipment into an outlet on a circuit different from that to which the receiver is connected.
- Consult the dealer or an experienced radio/television technician for help.

**Caution:** Any changes or modifications to this equipment not expressly approved by Texas Instruments may void your authority to operate the equipment.